

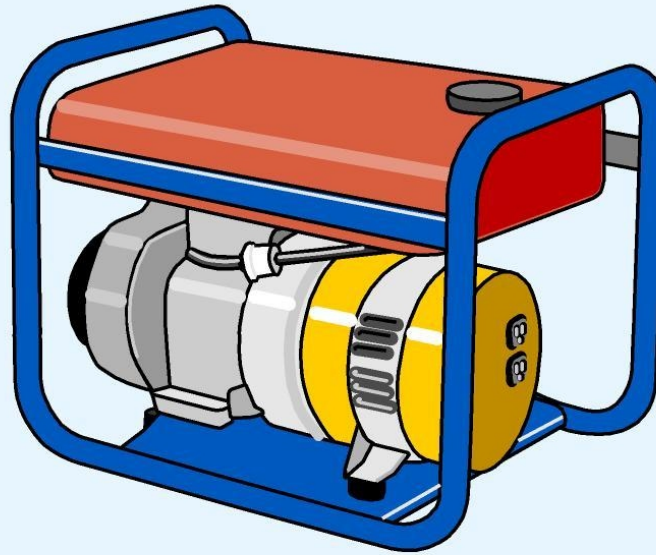





# Portable generator safety

When the power goes out a portable generator can be a lifesaver, but used improperly it also can become life-threatening.



## Symptoms of carbon monoxide exposure

These are possible complications average adults may expect from different percentages of carbon monoxide in their blood:

-  **10 percent:** Headaches may develop, or there may be no apparent symptoms. A carbon monoxide detector will activate.
-  **15 to 25 percent:** Headache and nausea.
-  **30 to 35 percent:** Drowsiness, weakness, dizziness, dimmed vision, severe headache, nausea and vomiting.
-  **40 percent:** Confusion, increased heart rate and blackout spells.
-  **45 percent:** Convulsions, permanent brain damage.
-  **50 percent:** Convulsions, coma and death.

DANGER	REASON	PREVENTION
Carbon monoxide poisoning	Gasoline-powered generators exhaust carbon monoxide, a colorless, odorless gas that displaces oxygen in the hemoglobin of the red blood cells.	Operate generators away from the house, in a well ventilated area. If it's in the garage, make sure the garage is open.
Backfeed shock	The generator is connected to the home's wiring system, posing a hazard to anyone working on powerlines.	Plug appliances you want powered directly into the generator. If powering a hard-wire item, such as the furnace fan, you will need a transfer switch. The switch should only be installed by a licensed electrician and requires an electrical permit and an electrical inspection.
Fire	Overloaded cords can overheat and cause fires. Small gasoline engines can sometimes backfire, causing sparks.	Be sure extension cords are properly sized to carry the electric load. Install a spark arrest muffler and keep the generator away from combustible material.



### Halifax Regional Fire & Emergency, Fire Prevention Division

Alderney Gate, 40 Alderney Drive, 1st Floor, Dartmouth, NS B2Y 2N5

Phone: 902 490-5546 Fax: 902 490-5228 Email: [fireprevention@halifax.ca](mailto:fireprevention@halifax.ca) Web: [www.halifax.ca/fireprevention](http://www.halifax.ca/fireprevention)