



P.O. Box 1749
Halifax, Nova Scotia
B3J 3A5 Canada

Item No. 2
Transportation Standing Committee
December 13, 2018

TO: Chair and Members of the Transportation Standing Committee

Original Signed

SUBMITTED BY:

Dave Reage, Director, Halifax Transit

Original Signed

Jacques Dubé, Chief Administrative Officer

DATE: October 9, 2018

SUBJECT: Relocation of Express Buses from Gottingen Street

INFORMATION REPORT

ORIGIN

At the March 6, 2018 meeting of Regional Council, the following motion was put and passed:

That Halifax Regional Council proceed with detailed design of a continuous northbound bus lane on the Gottingen Street corridor at peak (7am-9am and 3pm-6pm, Monday to Friday), with a provision for intermittent northbound transit priority measures off peak, that will include allowing short duration time regulated (15-90 minute) parking and loading where appropriate, and to return to the Transportation Standing Committee with:

1. A Parking Loss Mitigation Plan which includes engagement with the public and stakeholders, returning with a recommendation prior to tendering the project;
2. A supplementary report regarding the potential for moving northbound express buses (as planned) to a different route and moving Dartmouth bound express buses to Barrington Street via the Bridge ramp.
3. A plan to measure and evaluate the impact of the project and recommend changes, if any, within one year of implementation.

LEGISLATIVE AUTHORITY

Transportation Standing Committee Terms of Reference, section 4 (a) which states: "The Transportation Standing Committee shall oversee and review the Municipality's Regional Transportation Plans and initiatives, as follows: overseeing HRM's Regional Transportation Objectives and Transportation Outcome Areas".

Halifax Regional Municipality Charter, subsection 69(1): “The Municipality may provide a public transportation service ...”

Halifax Regional Municipality Charter, subsection 318(2): “In so far as is consistent with their use by the public, the Council has full control over the streets in the Municipality.”

Halifax Regional Municipality Charter, subsection 322(1): “The Council may design, lay out, open, expand, construct, maintain, improve, alter, repair, light, water, clean, and clear streets in the Municipality.”

BACKGROUND

The Halifax Transit *Moving Forward Together Plan* (MFTP), approved by Regional Council in April 2016, identifies Bayers Road and Gottingen Street as critical choke points for transit service into and out of downtown Halifax that require transit priority. To improve transit service on these corridors, the MFTP recommends investment in transit priority measures (TPMs) that provide priority to the movement of buses over general traffic. On December 5, 2017, Regional Council approved the IMP, which includes direction to prioritize the delivery of transit priority corridors on Bayers Road, Gottingen Street, Robie Street, and Young Street. At the August 14, 2018 meeting of Regional Council, staff were directed to proceed with the implementation of a peak period northbound bus only lane on the Gottingen Street corridor (find staff report including detailed design of approved bus only lane in Attachment A to this report).

The MFTP also identifies an increase of transit vehicles operating on Gottingen Street during the peak periods, from approximately 79 buses per hour to approximately 90 buses per hour. At peak period, it is anticipated that 35 of those buses will be making a limited number of stops along the Gottingen Street corridor, and an additional 20 will be making no stops along the Gottingen Street corridor. Of those making a limited number of stops, 13 are Dartmouth bound express routes using Gottingen Street to access the Macdonald Bridge. The remainder (up to 35 buses/hour) are local service and could be stopping at all stops.

Residents and the business community have expressed concern for the volume of buses travelling along the Gottingen Street corridor, noting that the bulk of service is not directly providing service to residents of the corridor, but is instead designed to serve other residents travelling through the street to get to destinations beyond, to the detriment of the street itself.

At present, it is not possible for Halifax Transit vehicles (forty-foot or sixty-foot conventional transit vehicles) to access the Macdonald Bridge via the ramp from Barrington Street due to the geometry at the intersection of the Macdonald Bridge Ramp and North Street: buses cannot make the right turn from the curb lane of the bridge ramp to the curb lane of the Macdonald Bridge without swinging wide into the centre (reversing) lane of the bridge. Without the ability to access the bridge from the Macdonald Bridge Ramp, at present, the most direct route for Dartmouth bound service leaving downtown Halifax is via Cogswell Street and Gottingen Street to North Street.

In October 2017, this assumption was reconfirmed when, in partnership with Halifax Harbour Bridges (HHB), several turning maneuvers were trialled during a temporary lane closure to see if a simple geometric or signalling change to the intersection could allow buses to make this movement safely and reliably. Upon analysis of video footage, HRM staff and HHB determined this movement could not be made without turning into the centre lane, thus impeding traffic Dartmouth bound (PM peak) or oncoming, Halifax-bound traffic (AM peak).

At the March 6, 2018 meeting of Regional Council, staff were directed to report on the potential for relocating northbound express buses as described in the MFTP to an alternative route, and relocate Dartmouth bound express buses to Barrington Street to travel to Dartmouth via the Macdonald Bridge ramp. This report analyses several potential routing options and considerations, and considers the impact to infrastructure required to make these routing changes.

DISCUSSION

Transit Demand: Gottingen Street Routing vs. Barrington Street Routing

At present, Gottingen Street represents an area of high transit demand and observably high transit ridership. The following table summarizes observed boardings on the average day from October 2017 to October 2018:

Table 1: Average Daily Boardings - Gottingen Street and Barrington Street

Corridor	Average Daily Boardings (October 2017 - October 2018)
Gottingen Street (Cogswell Street to North Street)	964
Barrington Street (Cogswell Street to North Street)	665

This discrepancy in average boardings is likely due to several reasons, including the fact there is notably lower levels of transit service on Barrington Street. This is also likely due to the adjacent land uses on Gottingen Street generally being more transit supportive, a topic explored further below.

Transit Supportive Land Use

Gottingen Street is a walkable, mixed use destination. It offers a diversity of amenities including shopping, services, schools, cultural amenities and other features such a public library. The adjacent road network is porous and provides pedestrians easy access to the neighbourhood. Recent developments have seen an increase in residential density at some locations, again enhancing the transit supportive nature of the corridor. A screen line count undertaken in May 2018 further indicated that during the PM peak period, transit users represent 47.5% of people travelling along Gottingen Street.

Table 2: Individual Screen Line Counts - Modal Splits by Direction of Travel (Gottingen St, PM Peak)

Direction	Auto	Transit	Pedestrian	Cyclist	Total
Northbound	35%	57.3%	7.3%	0.4%	100%
Southbound	71.3%	11.9%	15.2%	1.6%	100%
Both Directions	42.8%	47.5%	9.0%	0.7%	100%

By contrast, Barrington Street between Cogswell Street and the Macdonald Bridge Ramp is typically less walkable, and has less of the land use variability required to create a vibrant pedestrian environment. To the east of the corridor is largely HMC Dockyard, with access limited to several gates along Valour Way. The west side of the corridor is largely residential with some auto-oriented services. The Barrington Street cross section is wider, and average speeds tend to be higher than Gottingen Street.

Level of Transit Service

Another factor which impacts the average daily boardings along each of these corridors is the level of transit service currently provided. The table below summarizes the planned hourly bus volume during the PM peak today and as per the approved *Moving Forward Together Plan*:

Table 3: PM Peak Buses – Existing and Planned

Corridor	PM Peak buses/hr (existing)	PM Peak buses/hr (planned – MFTP)
Gottingen Street (Cogswell Street to North Street)	79	90
Barrington Street (Cogswell Street North Street)	57	55

The difference in the amount of transit service provided, both currently and into the future has an impact on transit ridership on the respective corridors. It is anticipated that if there was an increase in service along the Barrington Street corridor, there would be a resultant increase in ridership.

Relocating Dartmouth Bound Buses – Express and Limited Stop Services

This section describes the interventions required for Dartmouth bound buses to make use of the Macdonald Bridge Ramp, and describes the routes which would be considered for relocation should the bridge ramp become navigable by buses.

Required Bridge Ramp Interventions

In order to consider the potential for relocation of Dartmouth bound buses to the Macdonald Bridge Ramp, more information was required regarding the potential interventions that would permit buses to make the maneuver from the ramp to the bridge safely.

To that end, HRM staff contracted CBCL Limited to undertake an analysis of the ramp, recommend scenarios which would permit the movement, and detail the impact any intervention may have on traffic queuing on the bridge ramp, Barrington Street, and North Street. The findings of this report are summarized below, and the complete final report from CBCL can be found in Attachment B to this report.

Scenarios considered

CBCL Limited was hired in July 2018 to confirm the findings of the previous trials, and identify modifications that would allow Halifax Transit buses to safely access the Macdonald Bridge using the Macdonald Bridge Ramp.

Their review confirmed that buses cannot safely turn onto the Macdonald Bridge, from the Barrington Street on-ramp. Four options that would allow buses to safely use the Barrington Street on-ramp were considered during this study. CBCL prepared functional drawings, considered the impacts to traffic, and prepared class D cost estimates for each option, and their complete report can be found in Attachment B. The options examined are described below:

Option 1: Left Lane on Ramp for Transit Only

In this option, the existing left lane on the bridge ramp would be used by transit only. By starting the turn in the left lane, the bus is provided enough space to safely maneuver from the ramp to the curb lane on the bridge. Buses should be using the curb lane while traveling across the bridge, so a dedicated transit signal phase would be needed to allow buses to enter the curb bridge lane, ahead of general traffic. This was the lowest cost option, estimated at \$63,000, but also has the highest impact to traffic. This option effectively reduces the bridge ramp to one lane of general traffic during the afternoon peak hours. This was found to have an unacceptable impact to general traffic, and transit.

Option 2: Widening at Intersection to Permit Right Turn from Curb Lane

In this option, the existing two lane cross section on the ramp would be widened so buses could make the turn from the right lane on the ramp to the curb lane on the bridge. To accommodate these widened lanes, the pedestrian crossing would be lengthened by approximately 3m, accomplished by reducing the size of the existing pedestrian island. This option will have a notable negative impact on pedestrians crossing this busy intersection due to increased crossing distance. This cost estimate for this option is \$251,000. This option is not expected to have a noticeable impact to general traffic. This option will provide transit and general traffic with equal priority.

Option 3: Lagging Transit Signal and Left Lane Transit Layby

In this option, the left ramp lane would be widened to accommodate a transit layby lane. Buses would pull into this lane, and wait for the end of the green signal cycle. A transit signal, after the green cycle, would allow transit to make a similar turn to option 1 (i.e. from the left lane into the curb lane on the bridge). The cost of this option is estimated at \$221,000. The impact to general traffic for this option is less than that of Option 1, because two lanes of general traffic would still be maintained. However, this option is also expected to have a significant impact on traffic due to the change to signal timing required to accommodate the transit only phase. The bridge ramp is typically congested during the afternoon peak hours with the existing operation, and this will increase delay. General traffic will have slightly higher priority compared to transit in this scenario.

Option 4: Right Lane Transit Lay By

In this option, a transit layby would be added to the right side of the bridge ramp, where there is currently a pull over area used by the Halifax Harbour Bridge (HHB) staff. The pull over for HHB must be maintained, as staff use this area to monitor large container ships as they pass under the bridge to ensure that the ships clear the bridge, as expected. This option would require a new platform to be constructed, for use of HHB staff, as the existing layby would be used by transit vehicles. The estimated cost for this option is \$685,000. Like Option 3, while transit vehicles will be removed from the queue on the approach to the intersection, this option will impact traffic due to the additional signal time added for a transit only phase. General traffic will have slightly higher priority compared to transit in this scenario.

The preferred concept is Option 2, as it provides the highest benefit relative to the cost. The impacts to traffic are negligible, and will have the lowest delay for buses as well. It requires no major structural changes to the Macdonald Bridge, however there are also shortcomings to other road users including an increase to the pedestrian crossing distance of 3m.

The impact of the lengthened crossing could be mitigated by the introduction of a “No Right on Red” regulation however, at this time the implications of that change are still being considered. If directed by staff to undertake further study of this measure, a detailed design will be developed.

Next Steps

To pursue this modification, the municipality can work with Halifax Harbour Bridges to undertake a detailed design for the bridge ramp modifications and obtain a refined cost estimate. It is not recommended that this design work commence immediately, as no short-term modifications to routing are recommended by this report. If, upon the completion of the Cogswell Interchange redevelopment project, it's found that travelling to Dartmouth via the Macdonald Bridge Ramp offers significant time savings, then the design work required to implement this modification could be planned for and included in a future budget year.

Dartmouth Bound Bus Routes

The following table summarizes the routes from the MFTP which will travel along Gottingen Street to access the Macdonald Bridge and Dartmouth.

Table 4: Planned Dartmouth Bound Bus Volume (PM Peak)

Future Dartmouth Bound Volumes - Gottingen St. PM Peak					
	Northbound		Southbound		Total
	Route	Peak Trips/Hour	Route	Peak Trips/Hour	Trips/Hour
Local Service (All Stops)	1	6	1	6	12
	5	4			4
	10	8			8
	50	3			3
Limited Stop (Some Stops)	158	2			2
	159	3			3
	161	4			4
	165	2			2
	168	2			2
Express Service (No Stops)	320	2	320	2	4
	370	2	370	0	2
Summary					
ALL Stops		21		6	27
Limited Stops		13		0	13
No Stops		4		2	6

As per the table above, under the future MFTP routing, during the peak periods, of the Dartmouth bound routes, approximately six trips per hour are not making any stops along Gottingen Street, and 13 trips per hour will be making limited stops along the corridor. A total of 27 trips per hour will be providing local service (makes all stops).

Potential for Relocation of Dartmouth Bound No Stop/Limited Stop Routes

Should the Macdonald Bridge Ramp be modified to make it navigable for buses, the following Dartmouth bound routes could be relocated to Barrington Street, as they would not be making any stops along the corridor:

- 320 Airport/Fall River
- 370 Porters Lake

These routes do not currently provide any benefit for residents or businesses along Gottingen Street, and could be relocated. This represents a decrease of six trips per hour in the PM peak (four northbound, four southbound).

The following planned Limited Stop services could also be considered for relocation:

- 158 Woodlawn Express
- 159 Colby Express
- 161 North Preston Express
- 165 Caldwell Express
- 168 Cherrybrook/Auburn Express

These limited stop, express routes, once implemented, will provide some service to residents of Gottingen Street, and today, similar routes have approximately 20 boardings per day (between Cogswell Street and

North Street). However, because of the low overall impact on ridership, these routes could be relocated to Barrington Street without changing the general purpose of the route.

The relocation of some or these routes could represent a decrease of 13 trips per hour in the PM peak.

Potential for Relocation of Dartmouth Bound Local Service

Should the Macdonald Bridge Ramp be modified, it is recommended that the following planned local route be considered for relocation to Barrington Street:

- 10 Dalhousie (all branches)

The MFTP describes the Route 10 as travelling inbound (i.e. to Dalhousie) via Barrington Street and outbound (i.e. to Dartmouth) via Gottingen Street. If the Macdonald Bridge Ramp were navigable by buses, amending the Route 10 to travel inbound and outbound along the same route is consistent with the Moving Forward Principle of introducing a simplified, transfer-based network. Passengers wishing to travel to Dartmouth would still have several options from Gottingen Street, but transfers would be required to travel towards the Mic Mac Mall /Main Street Dartmouth.

The relocation of this route could represent a decrease of eight trips per hour on Gottingen Street in the PM peak.

Relocation of Dartmouth Bound Services – Timing/Considerations

There are several points related to the implementation of service changes which would realign some or all of the routes described above. Firstly, it is worthy of consideration that routes which provide limited stops and/or no stops on Gottingen Street can be – and should be – relocated to allow the most consistent and reliable trip for passengers, as well as the most direct routing wherever possible. Therefore, these routings are intended to be flexible, and to allow staff to maintain flexibility in the long term to adapt to changing traffic conditions, travel demands, and the implementation of Transit Priority Measures.

Over the next several years, staff anticipate that impacts of the Cogswell District Redesign project may vary from time to time. It is anticipated that some phases of work may require travel patterns for both transit vehicles and other automobiles to adapt. At some phases in the project some routes may be relocated to Brunswick Street, for example, and so in the short term, the ability to adapt to alternate routes during construction is required.

Due to the anticipated impact that the Cogswell District Redesign construction project will have on the Barrington Street corridor, staff recommend that the relocation of routes from Gottingen Street be postponed until construction is complete and the impact of the final design is better understood. In the interim, staff will continue to monitor and evaluate the travel time on various routings, both during and after construction. Upon the completion of the Cogswell District Redesign project, staff will recommend route changes in the subsequent Annual Service Plan.

Contrary to Express Routes which are extremely time sensitive and require continued monitoring in changing traffic conditions to ensure optimal routing, Corridor Routes such as the Route 10 may provide a less direct routing in order to make the network more consistent with the Moving Forward Principles. In the case of the Route 10, in an effort to make the network easier to understand and more navigable for passengers, if travel times and reliability are at least comparable upon the completion of the Cogswell District Redesign projects, it would be preferable that the route be realigned to travel both inbound and outbound on Barrington Street as opposed to existing routing (inbound on Barrington Street and outbound on Gottingen Street).

Consideration for Routing via Brunswick Street

In the past, there have been several Dartmouth bound routes which have used Brunswick Street to access the Macdonald Bridge. At this time, no transit routes use this routing, and the manoeuvre from Brunswick Street to North Street is physically impossible due to infrastructure which was implemented in order to reduce shortcutting.

Consideration has been given to relocating several limited stop and/or express routes from Gottingen Street to Brunswick Street, however, this is not recommended for the following reasons:

- Land Use: Brunswick Street is classified as a local street and has the characteristic of a more residential street. It is therefore considered a less viable routing alternative.
- Geometry: As described above, at this time, it is not possible for Halifax Transit (or any vehicles) to access the Macdonald Bridge from Brunswick Street. While it is possible that a new transit priority measure could be implemented to allow buses only to make the right turn from Brunswick Street to North Street, additional analysis should be completed following the Cogswell District Redesign project to fully understand the implications of this.

At this time, any modifications to routes to travel along Brunswick Street to access the Macdonald Bridge are not recommended, as the impacts of the Cogswell District Redesign project on travel patterns during construction are unknown and it is anticipated that travel times will be highly variable for the duration of the project.

Halifax Bound Bus Routes

The following table summarizes the routes from the MFTP which will travel along Gottingen Street to access destinations on Peninsular Halifax, Mainland Halifax, Clayton Park, Bedford or Tantallon.

Table 5: Planned Outbound Bus Volumes, not Dartmouth bound: (PM Peak)

Future Halifax Bound Volumes - Gottingen St. PM Peak					
	Northbound		Southbound		Total
	Route	Peak Trips/Hour	Route	Peak Trips/Hour	Trips/Hour
Local Service	7	4	7	4	8
Limited Stop (Some Stops)	135	4	135		
	136	3	136		
	137	3	137		
	138	4	138		
	186	2	186		
	192	2	192		
	194	2	194		
Express Service	330	6	330	0	6
ALL Stops		4		4	8
Limited Stops		22		0	22
No Stops		6		0	6

As per the previous table, under the future MFTP routing, during the peak periods, of the Halifax-bound routes, approximately 6 trips per hour are not making any stops along Gottingen Street, and 22 trips per hour will be making limited stops along the corridor. A total of 8 trips per hour will be providing local service (makes all stops).

Potential for Relocation of Halifax Bound No Stop/Limited Stop Routes

There is one future MFTP route that is currently planned to travel on Gottingen Street that would not make any stops:

- 330 Tantallon/Sheldrake Lake

This route would not provide any benefit for residents or businesses along Gottingen Street, and could be relocated to an alternative corridor provided the resultant route had a comparable travel time and reliability. This would represent a decrease of six trips per hour in the PM peak.

The following planned Limited Stop services could also be considered for relocation from Gottingen Street:

- 135 Flamingo Express*
- 136 Farnham Express*
- 137 Regency Park Express (Clayton Park Express) *
- 138 Parkland Express*
- 186 Basinview Express
- 192 Southgate Express
- 194 Bedford West Express*
- 196 Starboard Express

These limited stop, express routes, provide some service to residents of Gottingen Street, and currently, the routes which have already been implemented (identified with an asterix) have approximately 42 boardings per day on Gottingen Street. Although the express routes all serve different areas in Clayton Park and Bedford, on the Halifax Peninsula, they consistently travel along Massachusetts Avenue, Gottingen Street, Cogswell Street, and Barrington Street, with some continuing onto Spring Garden Road and Summer Street, and others serving Morris Street and University Avenue.

Because of the low overall impact on ridership, these routes could be relocated to an alternate corridor without changing the general purpose of the route, provided that the relocation would have a net positive impact on reliability and running time. At this time, the existing routing is provided for reliability and consistency, and it is not recommended that the Clayton Park and Bedford bound routes be realigned. However, if transit priority is introduced on Robie Street as is recommended in the Integrated Mobility Plan, then alternate routing on Robie Street may be preferable. However, should these routes be rerouted to Robie Street, there will be reduced access to CFB Stadacona.

Relocation of Clayton Park and Bedford Bound Services – Timing/Considerations

The MFTP states the following:

“As TPMs are made implemented, consideration must be given to the realignment of existing routes in order to provide as many routes as possible with the benefits provided by the faster and more reliable travel time.”

At this time, transit priority exists on Gottingen Street, allowing for more reliable travel times than on other parallel corridors on the Peninsula. However, if transit priority is introduced on Robie Street, Young Street, and Bayers Road as recommended by the Integrated Mobility Plan, then the improvement in travel time and reliability in that corridor could warrant relocation of the Bedford, Clayton Park, and Tantallon/Sheldrake Lake express routes. However, at this time, the relocation is not recommended until such a time that transit priority is provided along the routes described above. Congestion levels are very heavy along portions of

this corridor, particularly on Bayers Road, and it is anticipated that if transit priority measures are installed, there may be construction related delays in the short term. It is recommended that the potential for re-routing these express services be reconsidered in the coming years upon the completion of major transit priority projects.

FINANCIAL IMPLICATIONS

There are no financial implications directly associated with this report.

As per the consultant's report, the anticipated construction costs for the Macdonald Bridge Ramp modifications is \$251,000.

In addition, there are costs associated with completing the detailed design of the bridge ramp modification. This work is estimated at \$30,000.

It is possible that the modifications of some or all of the routes described in this report may result in changes to operating costs. These changes will be evaluated and brought forward as part of the Annual Service Plan and through the budget process in future years.

COMMUNITY ENGAGEMENT

No community engagement has been undertaken in the preparation of this report.

ATTACHMENTS

Attachment A: Transit Priority Corridors-Gottingen St Report dated February 23 2018

Attachment B: Bridge Ramp Consultant Report dated October 2018

Attachment C: Transit Priorities Corridor Gottingen St Report Dated July 31 2018

A copy of this report can be obtained online at halifax.ca or by contacting the Office of the Municipal Clerk at 902.490.4210.

Report Prepared by: Erin Blay, MCIP, LPP, Supervisor, Service Design & Projects, Halifax Transit
902.490.4942



P.O. Box 1749
Halifax, Nova Scotia
B3J 3A5 Canada

Item No. 14.3.1
Halifax Regional Council
March 6, 2018

TO: Mayor Savage and Members of Halifax Regional Council

Original Signed

SUBMITTED BY: _____
Councillor Tim Outhit, Chair, Transportation Standing Committee

DATE: February 23, 2018

SUBJECT: Transit Priority Corridors: Gottingen Street

ORIGIN

February 22, 2018 meeting of the Transportation Standing Committee, Item No. 8.1.

LEGISLATIVE AUTHORITY

Administrative Order 1, Respecting the Procedures of the Council, Schedule 7, Transportation Standing Committee Terms of Reference, section 4 (d):

Duties and Responsibilities

4. The Transportation Standing Committee shall oversee and review of the Municipality's Regional Transportation Plans and initiatives, as follows: providing input and review of the Transportation Road network strategies and related Regional initiatives.

RECOMMENDATION

That the Transportation Standing Committee recommends that Halifax Regional Council proceed with detailed design of a continuous northbound bus lane on the Gottingen Street corridor at peak (7am-9am and 3pm-6pm, Monday to Friday), with a provision for intermittent northbound transit priority measures off peak, that will include allowing short duration time regulated (15-90 minute) parking and loading where appropriate, and to return to the Transportation Standing Committee with:

1. A Parking Loss Mitigation Plan which includes engagement with the public and stakeholders, returning with a recommendation prior to tendering the project;
2. A supplementary report regarding the potential for moving northbound express buses (as planned) to a different route and moving Dartmouth bound express buses to Barrington Street via the Bridge ramp.
3. A plan to measure and evaluate the impact of the project and recommend changes, if any, within one year of implementation.

BACKGROUND

A staff report dated January 25, 2018 pertaining to Transit Priority Corridors for Gottingen Street was before the Transportation Standing Committee for consideration at its meeting held on February 22, 2018.

For further information, please refer to the attached staff report dated January 25, 2018.

DISCUSSION

Staff provided a presentation and responded to questions of clarification from the Transportation Standing Committee in relation to the proposed Transit Priority Corridors for Gottingen Street. The Transportation Standing Committee forwarded an alternative recommendation to Halifax Regional Council as outlined in this report.

FINANCIAL IMPLICATIONS

As outlined in the attached staff report dated January 25, 2018.

RISK CONSIDERATION

As outlined in the attached staff report dated January 25, 2018.

COMMUNITY ENGAGEMENT

The Transportation Standing Committee meetings are open to public attendance, a live webcast is provided of the meeting, and members of the public are invited to address the Committee for up to five minutes at the end of each meeting during the Public Participation portion of the meeting. The agenda, reports, video, and minutes of the Transportation Standing Committee are posted on Halifax.ca.

ENVIRONMENTAL IMPLICATIONS

As outlined in the attached staff report dated January 25, 2018.

ALTERNATIVES

The Transportation Standing Committee considered an alternative recommendation as outlined in the recommendation section of this report. Additional alternative recommendations are outlined in the January 25, 2018 staff report.

ATTACHMENTS

1. Staff report dated January 25, 2018.

A copy of this report can be obtained online at halifax.ca or by contacting the Office of the Municipal Clerk at 902.490.4210.

Report Prepared by: Liam MacSween, Legislative Assistant, 902.490.6521.



P.O. Box 1749
Halifax, Nova Scotia
B3J 3A5 Canada

Attachment 1
Transportation Standing Committee
February 1, 2018
February 22, 2018

TO: Chair and Members of Transportation Standing Committee

ORIGINAL SIGNED

SUBMITTED BY:

Kelly Denty, Acting Director: Planning & Development

ORIGINAL SIGNED

Dave Reage, Director: Halifax Transit

DATE: January 25, 2018

SUBJECT: Transit Priority Corridors: Gottingen Street / Bayers Road

ORIGIN

- The Halifax Transit *Moving Forward Together Plan*, approved by Regional Council in April 2016, identified Bayers Road and Gottingen Street as critical choke points for transit service into and out of downtown Halifax that require transit priority.
- At the June 21, 2016 meeting of Regional Council, staff were directed to submit 16 proposed transit projects for cost-shared funding approval under the Public Transit Infrastructure Fund (PTIF). One of those projects proposed was the Transit Priority Corridors project.
- At the February 21, 2017 meeting of Regional Council, Halifax Regional Council authorized the Mayor and Municipal Clerk to sign the fifteen Contribution Agreements with the Minister of Municipal Affairs, to receive funding for public transit projects approved under the Public Transit Infrastructure Fund (PTIF), including one for the Transit Priority Corridors project.
- In May 2017, RFP 17-303 was awarded to WSP Canada Inc. to prepare functional designs for 'Transit Priority Corridors' on Bayers Road (Romans Avenue to Windsor Street) and Gottingen Street (North Street to Cogswell Street).
- At the December 5th, 2017 meeting of Regional Council, the Integrated Mobility Plan was approved, and staff were directed to include an implementation plan in the upcoming staff report for the Bayers Road and Gottingen Street Transit Priority corridors functional design to allow Council to consider construction in fiscal 2019/20.

LEGISLATIVE AUTHORITY

Transportation Standing Committee Terms of Reference, section 4 (a) which states: "The Transportation Standing Committee shall oversee and review the Municipality's Regional Transportation Plans and initiatives, as follows: overseeing HRM's Regional Transportation Objectives and Transportation outcome Areas".

Halifax Regional Municipality Charter, subsection 318(2): “In so far as is consistent with their use by the public, the Council has full control over the streets in the Municipality.”

Halifax Regional Municipality Charter, subsection 322(1): “The Council may design, lay out, open, expand, construct, maintain, improve, alter, repair, light, water, clean, and clear streets in the Municipality.”

RECOMMENDATION

It is recommended that the Transportation Standing Committee recommend that Halifax Regional Council:

1. Proceed with detailed design of a dedicated northbound bus lane on the Gottingen Street corridor, including a Parking Loss Mitigation Plan which includes engagement with the public and stakeholders, and return to Council with a recommendation prior to tendering the project.
2. Proceed with detailed design of dedicated bus lanes in both directions on the Bayers Road corridor, including reconfiguration of the Halifax Shopping Centre intersection.

EXECUTIVE SUMMARY

The Halifax Transit *Moving Forward Together Plan* (MFTP), approved by Regional Council in April 2016, identifies Bayers Road and Gottingen Street as critical choke points for transit service that require transit priority. To improve transit service on these corridors, the MFTP recommends investment in transit priority measures (TPMs) that provide priority to the movement of buses over general traffic. These recommendations have been further reinforced by policy direction in the recently adopted *Integrated Mobility Plan* (IMP). When the IMP was adopted in December 2017, Regional Council also directed staff to include an implementation plan for Bayers Road and Gottingen Street so that Council could consider construction in fiscal 2019/20.

The physical characteristics of the corridors, as well as how people use them, have a major influence on the type of transit priority measures that can be implemented. Also, as is typical with any project that involves reconfiguration of an existing street, there are trade-offs that need to be considered. Where right-of-way expansion is necessary, there may be impacts to utilities, private property, and other infrastructure. Loss of traffic lanes and curb access used for on-street parking, loading, and stopping may also be necessary. These impacts are consistent with the IMP, which notes that parking management should be aligned with the goal of shifting more trips to active transportation, transit and car-sharing, while supporting growth in the Regional Centre. Effectively managing the supply of parking can help to influence travel habits and improved parking efficiency can reduce the amount of space needed for parking. As an initial phase of detailed design, a Parking Loss Mitigation Plan will be carried out in consultation with local Gottingen Street businesses to help ensure that adequate short-duration parking is provided for this important commercial area.

Following approval of the MFTP and securement of funding support from the Public Transit Infrastructure Fund (PTIF), a consultant was retained in May 2017 to complete a functional design study for transit priority corridors on Bayers Road and Gottingen Street. Multiple design options were completed for each corridor, representing a range of investment scenarios. The design options were evaluated based on various criteria that considered the potential to improve transit operation, multimodal impacts (walking, bicycling, traffic), curbside impacts (parking, loading), implementation cost, and the feedback received from stakeholders and the public. Analysis was also completed to relate capital / operational costs to operational benefits and develop an understanding of the cost-effectiveness of each option.

Based on the findings of the functional design study, this report recommends that both the Bayers Road and Gottingen Street transit priority corridors be advanced to the detailed design stage. The recommended configuration for Gottingen Street includes a continuous northbound transit lane between Cogswell Street and North Street. The recommended configuration for Bayers Road includes continuous dedicated transit

lanes in both directions between Romans Avenue and Windsor Street. These recommendations, which will provide considerable improvements for transit service, are in accordance with the objectives of the MFTP and the IMP.

With approval of the recommendations in this report, the proposed transit priority corridors will move to the detailed design stage, which will provide further opportunity to refine the details of the corridor configuration and develop a comprehensive understanding of the implications of constructing the corridors. It is anticipated that detailed design will be completed using a combination of HRM staff resources and an external consultant, and will involve public and stakeholder engagement. Upon completion of the detailed design process, implementation will be subject to budget availability and approval of construction tenders by the CAO.

A projected implementation timeline has been developed for both the Gottingen Street and Bayers Road corridors. The recommended Gottingen Street transit priority corridor does not require property acquisition or significant construction works; therefore, it is anticipated that implementation can be completed during 2018. The recommended Bayers Road transit priority corridor configuration will require property acquisition and involves extensive construction works – it is possible that construction could be completed by 2020; however, there is potential that property acquisition could delay implementation beyond this timeframe.

BACKGROUND

The Halifax Transit *Moving Forward Together Plan* (MFTP), approved by Regional Council in April 2016, identifies Bayers Road and Gottingen Street as critical choke points for transit service into and out of downtown Halifax that require transit priority. To improve transit service on these corridors, the MFTP recommends investment in transit priority measures (TPMs) that provide priority to the movement of buses over general traffic.

In February 2017, Regional Council directed staff to enter into a contribution agreement with the federal government, under the Public Transit Infrastructure Fund (PTIF), for a project to study and design 'Transit Priority Corridors' on Bayers Road and Gottingen Street. The total project budget is \$250,000, the cost of which is being shared evenly between the municipality and federal government. The project, CM000014 Transit Priority Measures Corridor Study, is to be completed in two phases: a functional design study that identifies and evaluates design alternatives (Phase 1), followed by detailed design based on the preferred design options for the two corridors (Phase 2).

In May 2017, RFP 17-303 was awarded to WSP Canada Inc. (contract value \$133,664) to prepare functional designs for 'transit priority corridors' on Gottingen Street (North Street to Cogswell Street) and Bayers Road (Romans Avenue to Windsor Street), with the option to undertake the design of two further corridors pending direction from Regional Council through the Integrated Mobility Plan (IMP).

On December 5, 2017, Regional Council approved the IMP, which includes direction to prioritize the delivery of transit priority corridors on Bayers Road, Gottingen Street, Robie Street, and Young Street.

This report represents the conclusion of Phase 1 of this project.

Gottingen Street:

Gottingen Street is an arterial road that runs north-south between downtown Halifax and the north end of the Halifax peninsula. It has a diverse mixture of land uses, and recent, ongoing, and planned development projects are rapidly increasing the density of residential and commercial uses on the street. A key roadway linking downtown to the Macdonald Bridge and points further north, Gottingen Street has daily traffic volumes exceeding 8,500 vehicles per day. There is limited available right-of-way on Gottingen Street, and physical widening of the street or right-of-way is not a viable alternative.

Transit on Gottingen Street

There are currently 18 Halifax Transit routes that travel on Gottingen Street, totalling 79 buses per hour (2-way) during the peak hour. Planned changes in the MFTP will increase the number of buses using Gottingen Street to a total of 90 during the peak hour. Some routes along Gottingen Street provide limited stops, and two routes do not stop at all between Cogswell Street and North Street. Transit service on Gottingen Street is hindered by traffic congestion during peak periods, as well as by the need for buses to manoeuvre around vehicles stopped or parked in the curb lanes throughout the day. The relatively narrow street width makes these manoeuvres particularly challenging, and transit vehicles are delayed an average of 5-6 minutes in the northbound direction during the afternoon peak hour. These delays can be significantly higher when incident-related traffic congestion occurs.

Bayers Road

Bayers Road is an arterial road that runs east-west between Joseph Howe Drive and Windsor Street. It is characterized mostly by single family homes, and there are also several commercial properties found along the length of the corridor including the Halifax Shopping Centre. A key link in the regional roadway network, Bayers Road accommodates more than 40,000 vehicles per day. Traffic congestion is prevalent during peak periods, often resulting in significant delays.

The 2014 *Regional Municipal Planning Strategy* identifies expansion of the Bayers Road corridor for mixed traffic as a planned project to occur in conjunction with expansion of Highway 102 (Hammonds Plains Road to Bayers Road) by the Province. Specifically, this includes widening from four lanes to six lanes west of Connaught Avenue and widening from three lanes to four lanes between Connaught Avenue and Windsor Street. Though the corridor expansion has not yet been programmed for implementation, for several years the Municipality has been making strategic property acquisitions along Bayers Road to preserve the corridor. At present, most of the properties on either side of the section of Bayers Road between Highway 102 and Connaught Avenue are owned by HRM.

Transit on Bayers Road

At present, seven Halifax Transit routes travel on Bayers Road, totalling more than 40 buses per hour (2-way) during the peak hour. Planned changes in the MFTP will increase the number of buses using Bayers Road during the peak hour. Traffic congestion on Bayers Road has significant impacts to transit and reduces Halifax Transit's ability to provide a high quality, reliable service. Routes on Bayers Road regularly experience significant delays during peak periods – particularly during the afternoon – and at present, some trips on the Route 1 detour in the outbound direction on Roslyn Road to reduce delay.

Transit Priority Corridors

Bayers Road and Gottingen Street were identified as proposed transit priority corridors in the MFTP based on their importance for existing and planned transit operations, as well as the potential that they are expected to offer for providing priority to transit over general traffic. The type of transit priority proposed for the corridors was not identified in the Plan, recognizing that there are many factors that need to be considered in determining a preferred approach. The physical characteristics of the corridors, as well as how people use them, have a major influence on the type of transit priority measures that can be implemented.

Also, as is typical with any project that involves reconfiguration of an existing street, there are trade-offs that need to be considered. Where right-of-way expansion is necessary, impacts to private property and other infrastructure (e.g. water & sewer, power / communications lines, trees) may be required. Loss of traffic lanes and curb access used for on-street parking, loading, and stopping may also be necessary. These impacts are consistent with the IMP, which notes that parking management should be aligned with the goal of shifting more trips to active transportation, transit and car-sharing, while supporting growth in the Regional Centre. Effectively managing the supply of parking can help to influence travel habits and improved parking efficiency can reduce the amount of space needed for parking. As an initial phase of detailed design, a Parking Loss Mitigation Plan will be carried out in consultation with local Gottingen Street businesses to help ensure that adequate short-duration parking is provided for this important commercial area.

DISCUSSION

Following approval of the MFTP and securement of funding support from the Public Transit Infrastructure Fund (PTIF), Phase 1 of the project commenced after the selection of a consultant in May 2017 to complete a functional design study for the corridors. The primary objective of Phase 1 of the project was to investigate transit priority options and develop functional designs for transit priority corridors for Gottingen Street and Bayers Road. The scope of the consultant’s work included the following:

- Detailed investigation of existing conditions along each corridor and review of existing and projected multimodal transportation demands;
- Develop 2-3 conceptual design options representing a range of investment levels with input from the project steering committee and feedback from stakeholders;
- Public and stakeholder engagement related to the proposed design concepts;
- Identify any necessary property acquisition and utility relocation requirements for each option
- Evaluate multimodal level of service for the options that considers factors such as transit operational benefits, intersection performance impacts, parking / curb access, and road safety.

The consultant's findings and recommendations have been summarized in a design report appended to this report in **Attachment E**.

An overview of the Gottingen Street and Bayers Road corridors and the options considered for each are provided in **Attachment A** and **Attachment B**, respectively. The recommended options are summarized in the following sections:

Gottingen Street

Analysis Approach and Identification of Preferred Configuration

Options representing varying levels of investment (low, medium, and high) were considered for the proposed Gottingen Street transit priority corridor. A summary of the options that were considered is provided in **Attachment A** and further detailed in the consultant’s report in **Attachment E**. The preferred configuration for the Gottingen Street transit priority corridor, as summarized in Table 1, includes a dedicated northbound transit lane. Further detail and functional design sketches are provided on Pages 5-7 (**Attachment C**).

Table 1: Preferred Configuration Option – Gottingen Street Transit Priority Corridor

	Functional Sketch	Summary
<p>Cogswell Street to North Street</p>	 <p style="text-align: center;"><i>Gottingen Street (looking to the south)</i></p>	<ul style="list-style-type: none"> • Continuous outbound (northbound) lane for buses only (also permitted for use by right turning vehicles); • Installation of pedestrian signals at key pedestrian crossings; • Removal of on-street parking and loading

Summary of Impacts:

A summary of the impacts associated with the recommended transit priority corridor option for Gottingen Street is provided below:

- *Transit Service:* Significant transit improvement in the northbound direction. Buses avoid obstruction by parked cars and can bypass lengthy queues, reducing delay and improving reliability. It is estimated that these corridor-level transit priority measures will substantially reduce delay for northbound buses, benefiting approximately 1600 peak hour passengers over 56 trips.

During heavily congested periods, it is estimated that buses will experience significant reductions in delay – running times on Gottingen Street suggest that buses are regularly delayed by 5-6 minutes during the PM peak, and in some cases up to 15 minutes. The proposed transit priority corridor will enable buses to avoid these major delays, which will improve schedule adherence during congested periods and play an important role in making the service more attractive to users.

- *Active Transportation:* Minimal impacts. The addition of signalized crosswalks improves street crossing experience.
- *Traffic Impacts:* Slight improvement to traffic flow due to removal of on-street parking.
- *Property Impacts:* No impacts to private property.
- *Parking / Loading:* Removal of all on-street parking and loading on Gottingen Street (51 spaces). There may be potential to allow short-term parking or loading during overnight hours when buses are not running. A 'Parking Loss Mitigation Plan' will be included in the detailed design stage of the project. Work on the plan has already begun and will include further engagement with local businesses. The plan will determine actual parking demand and will identify areas where it can be accommodated in the immediate vicinity, including additional parking on side streets.

Summary of Stakeholder and Public Consultation Feedback:

The Gottingen Street concept options were presented to the public at an Open House on Monday, October 2nd, 2017, and a Shape Your City online consultation page was established. Feedback on the design options was obtained (via survey) from a total of 296 members of the public. Results are provided in **Attachment D**. The addition of transit priority on Gottingen Street was deemed favorable by more than 60% of survey respondents. Among the potential trade-offs associated with implementation of the presented options (parking / loading, traffic congestion, increased bus traffic, and implementation costs), the leading concerns were increased traffic congestion, loss of loading access, and increased bus traffic on the street. However, none of the trade-offs were deemed unacceptable by most respondents.

HRM consulted with representatives from the North End Business Association (NEBA) on July 26th, 2017, to introduce the project and develop an understanding of the priorities and concerns of the local business community. The NEBA is concerned about how the project may impact Gottingen Street businesses and raised the following items for consideration:

- ***The potential loss of on-street parking and loading on Gottingen Street and its perceived impact on the viability of local businesses:*** As noted above, the detailed design stage of the project will include a 'Parking Loss Mitigation Plan' that includes a parking utilization study for Gottingen Street and the surrounding streets. While it is likely that there will be some net loss of on-street parking, this is consistent with curbside priority direction provided by the IMP, which prioritizes transit lanes over on-street parking and acknowledges the importance of replacing lost on-street parking where possible. Loading spaces will continue to be accommodated.
- ***The volume of buses that use Gottingen Street (existing and planned), and its perceived detrimental impact on the public realm:*** The public realm on Gottingen Street benefits from the significant number of people that buses bring to the street; this is also true for the businesses. Added transit priority will enable buses to move through the corridor more efficiently, thereby reducing the amount of bus idling on Gottingen Street while in traffic.
- ***The lack of consideration of alternatives that would reduce transit routing on Gottingen Street, including modified route configurations that could use alternate streets such as Barrington Street and Brunswick Street to service buses accessing the Macdonald Bridge (bus access to the bridge via these streets is constrained by the current ramp configuration):*** At present, Dartmouth bound buses must use Gottingen Street to access the Macdonald Bridge. Due to geometry on the Barrington Street ramp to the Macdonald Bridge, transit vehicles are unable to use this access. The Municipality and the Bridge Commission continue to work closely to investigate viable options that would permit this movement in a way that is safe, and enables buses to travel to Dartmouth from Halifax via Barrington Street. Interventions may be limited to small changes to the geometry of some road markings, however it is possible that it could require larger changes to the bridge ramp, which may be extremely costly.

However, even if the Barrington Street ramp did provide access for Dartmouth bound buses to the bridge, transit priority is still warranted on Gottingen Street for the buses which would still serve the many residents and businesses on this important corridor. There is high passenger demand on Gottingen Street: and this area is very walkable and is characterized by businesses and services which attract transit passengers and pedestrians alike. If the Barrington Street ramp were to be accessible to transit vehicles, only routes that do not currently make stops on Gottingen Street would benefit.



Brunswick Street is not considered a candidate for routing transit vehicles at this time. This street is a local street between Cogswell Street and North Street with lower traffic volumes, and the character of the street is largely residential. It lacks the commercial usage that Gottingen Street has, and thus does not have the same trip demand, attractions, or destinations. It is not currently possible for any vehicles to access the Macdonald bridge from Brunswick Street. At best, with the necessary intersection modifications at North Street, Brunswick Street could only accommodate buses travelling to Dartmouth and would not eliminate the need for transit priority on Gottingen Street.

Bayers Road

Analysis Approach and Identification of Preferred Configuration

Bayers Road was analyzed based on three distinct sections: (i) Romans Avenue to Halifax Shopping Centre, (ii) Halifax Shopping Centre and Connaught Avenue, and (iii) Connaught Avenue to Windsor Street. Multiple options representing varying levels of investment (low, medium, and high) were considered for the configuration of the proposed transit priority corridors for each section of Bayers Road. A summary of the options that were considered is provided in **Attachment B** and further detailed in the consultant's report in **Attachment E**. The preferred configuration for each of the three sections of Bayers Road are summarized in Table 2. Further detail and functional design sketches are provided on Pages 1-4 (**Attachment C**).

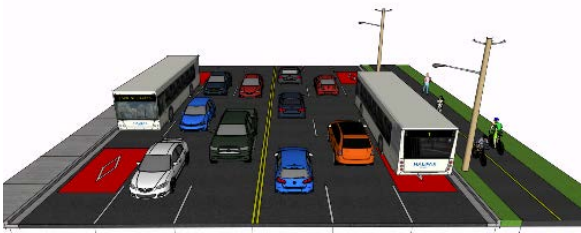
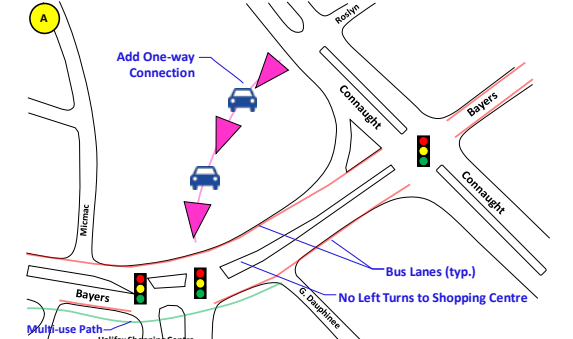
Table 2: Preferred Configuration Options – Bayers Road Transit Priority Corridor

	Functional Sketch	Summary
<p>Romans Avenue to Halifax Shopping Centre</p>	 <p><i>Bayers Road (looking to the east)</i></p>	<ul style="list-style-type: none"> • Widen from existing 4-lane cross section to a 6-lane cross section; • Add continuous eastbound and westbound dedicated bus lanes (also permitted for use by right turning vehicles); • Add a multi-use pathway on the south side of Bayers Road; • Most of required land has already been acquired by HRM, though more property acquisition will be required.
<p>Halifax Shopping Centre to Connaught Avenue</p>		<ul style="list-style-type: none"> • Left turns into Halifax Shopping Centre prohibited from Bayers Road, removing key source of congestion. • Add new one-way driveway connection to the Halifax Shopping Centre across HRM-owned vacant parcel. New connection provides increased capacity for traffic entering the Halifax Shopping Centre. Further consultation with the Halifax Shopping Centre will be required. • Add continuous eastbound and westbound dedicated bus lanes (also permitted for use by right turning vehicles);
<p>Connaught Avenue to Windsor Street</p>	 <p><i>Bayers Road (looking to the east)</i></p>	<ul style="list-style-type: none"> • Widen from existing 3-lane cross section to a 4-lane cross section; • Add continuous eastbound and westbound dedicated bus lanes (also permitted for use by right turning vehicles); • Property acquisition will be required. Several properties are affected, though it is not anticipated that impacts will be extensive. Removal of on-street parking and loading.

Summary of Impacts:

A summary of the impacts associated with the recommended transit priority corridor option for Bayers Road is provided below:

- **Transit Service:** Significant transit improvement in both directions, as buses avoid the traffic congestion that frequently occurs during peak periods. For example, it is estimated that these corridor-level transit priority measures will substantially reduce delay for outbound buses during the PM peak – running times on Bayers Road suggest that buses are regularly delayed by 13-14 minutes during the PM peak, and in some cases by up to 28 minutes (these improvements would benefit approximately 530 peak hour passengers, over 25 trips). The proposed transit priority corridor will enable buses to avoid these major delays, which will improve schedule adherence during congested periods and play an important role in making the service more attractive to users.
- **Active Transportation:** Multi-use path west of Connaught Avenue provides improved walking / cycling connection.
- **Traffic Impacts:** Slight improvement to traffic flow due to removal of buses from general traffic and decreased delay at the reconfigured Halifax Shopping Centre driveway intersection. The closely spaced intersections at Connaught Avenue and Bayers Road would benefit considerably from the intersection configuration, reducing confusion and operational challenges for all users.

- *Property Impacts:* Widening in constrained areas will require property acquisition. West of the Halifax Shopping Centre, most of required land has already been acquired by HRM, though more property acquisition will be required. East of Connaught Avenue, several properties may be affected, though the majority will not be significantly impacted (narrow strips of property frontage required).
- *Parking / Loading:* Loss of approximately 50 on-street parking spaces on Bayers Road between Connolly Street and Dublin Street.

Summary of Stakeholder and Public Consultation Feedback:

The Bayers Road corridor concept options were presented to the public at an Open House on Thursday, September 28th, and a Shape Your City online consultation page was established. Feedback on the design options was obtained (via survey) from a total of 488 members of the public. Results are provided in **Attachment D**. The addition of dedicated bus lanes on Bayers Road received a favorable response from more than 70% of respondents. Among the potential trade-offs associated with implementation of the presented options (property impacts, parking / loading, traffic congestion, increased bus traffic, and implementation costs), the potential for increased traffic congestion was the lone category that most respondents (54%) indicated was unacceptable.

HRM consulted with representatives from the Halifax Shopping Centre to review the concept options as they relate to the shopping centre driveway intersection. Based on preliminary feedback, Halifax Shopping Centre representatives have concerns about potential modifications to the existing access configuration, but indicated that they are open to further consultation as the project progresses.

Recommended Approach for the proposed Transit Priority Corridors:

It is recommended that both the Bayers Road and Gottingen Street Transit Priority Corridors be advanced to the detailed design stage. The recommended configuration for each corridor is described below:

Gottingen Street: Continuous northbound transit lane between Cogswell Street and North Street. Since the Gottingen Street options are quite scalable (most of the changes include modifications to signage, signals, and pavement markings and do not require land acquisition or have significant impacts to physical infrastructure), the recommended option could be modified relatively easily depending on how the facility operates and/or how its impacts to the street are perceived. Consideration could also be given to permitting on-street parking in the transit lane during specific periods with limited transit service such as overnight. Recommendations from the Parking Loss Mitigation Plan noted above will be included in the detailed design.

Bayers Road: Dedicated bus lanes (both directions) on Bayers Road between Romans Avenue and Windsor Street, and reconfiguration of the Halifax Shopping Centre intersection to include a new at-grade access leg via the HRM-owned vacant property at 6699 Bayers Road. During the detailed design process, further investigation should be completed to determine a preferred intersection configuration for the Halifax Shopping Centre driveway. Consultation with representatives from the Halifax Shopping Centre should also be continued during the design process.

Next Steps / Implementation Plan

At the February 21, 2017 meeting of Regional Council, Halifax Regional Council directed staff to provide an implementation plan for the Gottingen Street and Bayers Road corridors that allows consideration of the potential for construction during the 2019-20 fiscal year. The following describes the next steps that are anticipated to be required for implementation of both corridors.

Gottingen Street:

Based on Regional Council approval of the recommendations outlined in this report, an approximate implementation timeline is summarized in Table 3. Detailed design of the transit priority corridor will be completed by HRM staff. During detailed design, public and stakeholder engagement will be completed to provide opportunity for additional feedback on the design and related impacts.

Implementation of the recommended Gottingen Street transit priority corridor does not require property acquisition or significant construction works; therefore, it is anticipated that implementation can be completed during 2018.

Table 3: Estimated Implementation Timeline - Gottingen Street Transit Priority Corridor

Task	2018							
	J	F	M	A	M	J	J	A
1. Detailed Design ^{a b}								
2. Construction Tendering								
3. Award of Construction Tender ^c								
4. Construction								
Notes:								
a. Assumes Regional Council approval of staff recommendations in February 2018.								
b. Detailed design completed by HRM Planning & Development and Transportation & Public Works.								
c. CAO award of construction tender will be subject to budget availability.								

Bayers Road:

Based on Regional Council approval of the recommendations outlined in this report, an approximate implementation timeline is summarized in Table 4. Implementation of the Bayers Road transit priority corridor is significantly more complex than for Gottingen Street, and will require additional time, budget, and resources. Due to the anticipated need to acquire private property, there is also more schedule uncertainty.

A consultant will be retained to complete detailed design. During detailed design, public and stakeholder engagement will be completed to provide opportunity for additional feedback on the design and related impacts. Based on the detailed design, property acquisition requirements will be identified, and a construction budget estimate will be developed. The process of acquiring private property will have uncertain timelines that could delay the project. Award of a construction tender by the CAO will be required, subject to budget availability. Construction timelines are also uncertain, though it is expected that at least 3-4 months will be required.

Based on the estimated implementation timeline, it appears possible that construction of the proposed Bayers Road transit priority corridor can be completed by 2020. However, it is noted that certain elements of the implementation process – primarily property acquisition – do have the potential to delay the project to 2021 or beyond.

Table 4: Estimated Implementation Timeline - Bayers Road Transit Priority Corridor

Task	2018				2019				2020			
	Winter	Spring	Summer	Fall	Winter	Spring	Summer	Fall	Winter	Spring	Summer	Fall
1. Issue and Award RFP for Detailed Design ^a												
2. Detailed Design ^b												
3. Property Acquisition ^c												
4. Construction Tendering												
5. Award of Construction Tender ^d												
6. Construction ^e												

Notes:

- Assumes Regional Council approval of staff recommendations in February 2018.
- Detailed design completed by consultant.
- Property acquisition requirements will be determined based on the detailed design. The process of acquiring private property has uncertain timelines, and may vary considerably depending on the amount of property required.
- CAO award of construction tender will be subject to budget availability.
- Construction timelines for this project are uncertain. Mitigation of construction-related impacts on traffic will likely be desired due to the significance of the Bayers Road corridor. It has been assumed that construction will commence during spring, coinciding with the start of the road construction season.

Robie Street / Young Street: As recommended in the IMP, transit priority corridors are also being investigated on Robie Street and Young Street. Staff are currently working with WSP Canada Inc. on a functional design study for the two corridors. The design process will include public engagement in February 2018. Upon completion of the functional design study, a recommendation report will be submitted to Regional Council seeking direction to proceed to detailed design for a recommended corridor configuration. This report will also describe an estimated timeline for implementation of these corridors, which may include phasing. It is anticipated that the report will be submitted to Regional Council in spring 2018.

FINANCIAL IMPLICATIONS

The evaluation of the corridor options considered both capital and operating costs relative to operational benefits in identifying a preferred, cost-effective approach. The detailed design for Bayers Road will be funded from CM000014 Transit Priority Measures Corridor Study, the cost of which is estimated to be within the balance of \$116,336 available in the project account. The Bayers Road detailed design is funded through the Public Transit Infrastructure Fund (PTIF), which provides up to 50% of the project costs. The detailed design work for Gottingen Street will be undertaken by HRM staff resources at no additional cost to the Municipality.

Budget Summary: Project Account No. CM000014 Transit Priority Measures Corridor Study

Cumulative Unspent Budget	\$ 116,336
Less: estimated detailed design cost	<u>\$(116,336)</u>
Balance	\$ 0

The Gottingen Street transit priority corridor construction work – estimated at approximately \$250,000, but subject to detailed design – will be funded from project account CM000009, Transit Priority Measures, pending the approval of the 2018/19 capital budget.

Budget Summary: Project Account No. CM000009 Transit Priority Measures

Cumulative Unspent Budget	\$392,390
Anticipated 2018/19 Budget	\$350,000
Less: estimated construction cost	<u>\$(250,000)</u>
Balance	\$ 492,390

Construction of the recommended Bayers Road transit priority corridor is not budgeted at this time – the preliminary Class D cost estimate for construction, excluding property acquisition, is \$4.8 million – but the design will allow tender/construction to proceed when the funding opportunity/decision occurs.

RISK CONSIDERATION

There are no significant risks associated with the recommendations of this report. The risks considered rate low.

COMMUNITY ENGAGEMENT

Stakeholder and public consultation was completed to develop an understanding of the key issues on each corridor and solicit feedback on the presented concept designs.

- Stakeholder consultation sessions were held with the following groups:
 - North End Business Association
 - Halifax Shopping Centre (20Vic Management)
 - Halifax Cycling Coalition
 - It's More Than Buses
 - Walk & Roll
 - Canadian National Institute for the Blind (CNIB)
 - Dalhousie Transportation Collaboratory (DalTrac)

The information obtained from these groups was considered during the development of the design options, and incorporated into the options evaluation process.

- Public open consultation sessions were held for each of the Gottingen Street and Bayers Road corridors:
 - Bayers Road: Thursday, September 28th – Maritime Hall
 - Gottingen Street: Monday, October 2nd – George Dixon Centre

In addition, a Shape Your City online engagement portal was established for each corridor. Feedback was collected via in-person comments, a paper feedback survey, and an online survey (there were a total of 488 respondents for the Bayers Road survey, and 296 respondents for the Gottingen Street survey). The information obtained from public consultation was used to develop an understanding of priorities on each corridor and evaluate public response to the design options. Survey results are summarized in **Attachment D**.

Further engagement with Gottingen Street businesses, relative to on-street parking and loading impacts and the Halifax Shopping Centre, relative to its intersection at Bayers Road, will continue for both projects as they proceed through the detailed design process.

ENVIRONMENTAL IMPLICATIONS

This project is supportive of the Council Priority Outcome of building Healthy, Livable communities, as it aims to make it more convenient for residents to choose sustainable transportation options for everyday transportation purposes. This is reflected in the enhancements for transit, but also the improvements for

pedestrians and cyclists.

ALTERNATIVES

The Transportation Standing Committee may recommend to Regional Council that some or all of the recommendations not be approved or be modified. Alternatives for each of the Gottingen Street and Bayers Road and corridors are presented below:

Gottingen Street:

1. The Committee may recommend that Regional Council direct staff to introduce a 12-month pilot of a northbound transit lane on Gottingen Street in order to observe and monitor the impacts it may have on transit service reliability as well as local businesses and residents. This alternative is not recommended, as the transit benefits of the proposed measures are well understood at this time, and more than 60% of consultation survey respondents showed support for the measures.
2. The Committee may recommend that Regional Council direct staff to proceed to detailed design of intermittent transit priority measures in the northbound direction. This alternative is not recommended; while it does provide transit priority benefits, the overall transit benefit is considerably less than the continuous priority included in the high investment option, and the additional cost is only marginally lower.
3. The Committee may recommend that Regional Council direct staff to implement peak period parking / loading restrictions or recommend that no changes be made to the Gottingen Street corridor. These alternatives are not recommended, as they do not provide transit priority benefits contemplated by the MFTP and IMP.

Bayers Road:

1. The Committee may recommend that Regional Council direct staff to proceed to detailed design of dedicated bus lanes (both directions) on Bayers Road without reconfiguration to the Halifax Shopping Centre intersection. This alternative is not recommended, as it is not expected that effective transit priority can be provided through the section between Halifax Shopping Centre and Connaught Avenue under the existing intersection configuration.
2. The Committee may recommend that Regional Council direct staff to proceed to detailed design of a dedicated westbound bus lane on Bayers Road between Romans Avenue and Windsor Street. This alternative is not recommended, since it provides transit priority only in the outbound direction and does not achieve the benefits contemplated by the MFTP and IMP.
3. The Committee may recommend that Regional Council make no changes to the Bayers Road corridor. This alternative is not recommended, as it does not achieve the benefits contemplated by the MFTP and IMP.

ATTACHMENTS

Attachment A: Gottingen Street Summary and Design Options Overview

Attachment B: Bayers Road Summary and Design Options Overview

Attachment C: Functional Design Drawings

Attachment D: Community Consultation Results Summary

Attachment E: *Halifax Transit Priority Corridors: Gottingen Street and Bayers Road* (WSP, November 2017)

A copy of this report can be obtained online at halifax.ca or by contacting the Office of the Municipal Clerk at 902.490.4210.

Report Prepared by: Mike Connors, P.Eng., Transportation Engineer, Planning & Infrastructure, 902.817.0795

Report Approved by: Patricia Hughes, Manager Planning & Scheduling, Halifax Transit 902.490.6287

Report Approved by: Peter Duncan, Manager Infrastructure Planning, Planning & Development, 902.490.5449

Attachment A: Gottingen Street Summary and Options Overview

The Gottingen Street corridor was investigated between North Street and Cogswell Street (See Figure 1).

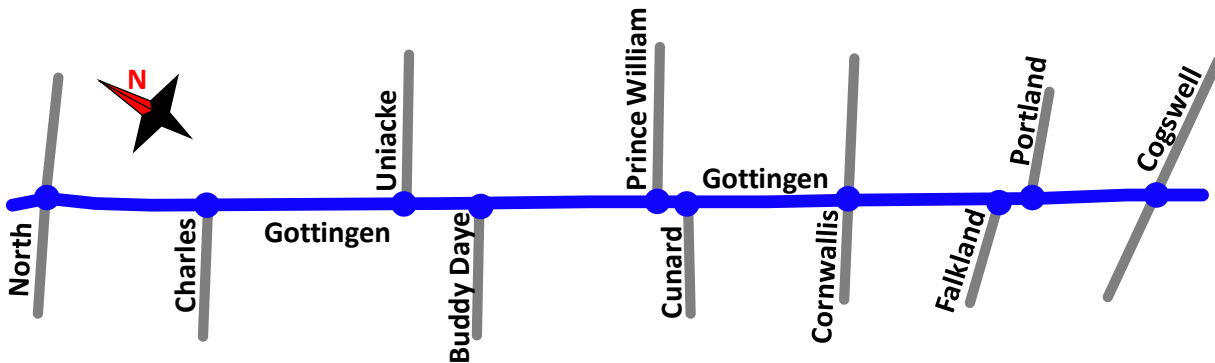

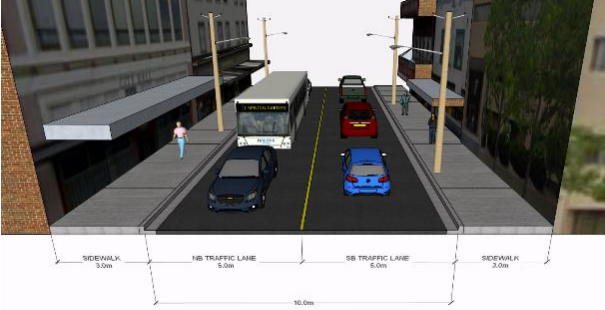

Figure 1: Gottingen Street Corridor

Table 1: Existing Conditions – Gottingen Street Corridor

<p>Vehicle Traffic</p>	<p>Key arterial street that provides a north-south connection between downtown Halifax and the bridge, as well as the north end and beyond</p> <p>Two lanes south of Uniacke Street</p> <p>Three lanes (2 northbound, 1 southbound) between Uniacke Street and North Street</p>
<p>Pedestrians / Cyclists</p>	<p><i>Walking:</i> An urban street with a diverse mixture of land uses, Gottingen Street is a busy pedestrian area. There are sidewalks on both sides of the street, though sidewalk width and separation from traffic lanes are limited by the narrow available right-of-way.</p> <p><i>Cycling:</i> Gottingen Street does not have any current or planned bicycle facilities. With a relatively narrow cross section and extensive transit service, it is not considered an ideal cycling route.</p>
<p>Transit</p>	<p>The Gottingen Street Corridor is served by the following routes at peak: 1, 7, 10, 11, 21, 31, 33, 34, 41, 53, 59, 61, 68, 86, 159, 320, 330, and 370. This is a total of approximately 79 trips at in the peak hour.</p> <p>The biggest impediment to bus operation on Gottingen Street is interaction with vehicles parked or stopped along the curb, which requires buses to awkwardly manoeuvre to get by them. The narrow curb-to-curb width exacerbates the challenges, often disrupting the flow of traffic in both directions.</p>
<p>Property Ownership</p>	<p>Available right-of-way along Gottingen Street is very limited. The typical curb-to-curb width is 10m, and building setbacks on both sides are typically very tight. It is not expected that property acquisition for the purposes of widening to expand the street is a viable approach.</p>
<p>Adjacent Land Uses</p>	<p>Diverse mix of residential and commercial</p>
<p>Parking and Loading</p>	<p>There are approximately 51 on-street parking spaces on Gottingen Street between Cogswell Street and Uniacke Street, all of which are time-limited (peak period, peak direction parking is restricted).</p> <p>Loading activities are completed from the existing parking spaces, in addition to one designated loading zone and any other locations not designated as 'No Stopping'.</p>

The design options presented in Table 2, which represent varying levels of investment, were developed for Gottingen Street. Functional design drawings, along with an overview of the implications (transit improvements and impacts to traffic, parking, and adjacent land uses), advantages, and disadvantages for the options for each section are provided on Pages 5 to 7, Attachment C.

Table 2: Design Options – Gottingen Street Corridor

	Description	Summary of Impacts
<p>Low Investment: Peak Period Parking / Stopping Restrictions</p>	 <ul style="list-style-type: none"> No explicit transit priority measures Parking and stopping restricted on both sides of the street during AM and PM peak periods 	<ul style="list-style-type: none"> Transit Service: Does not provide priority for buses over general traffic, though transit delays may improve due to improvements to general traffic flow Walking: No impact. Bicycling: Minimal impact. Fewer conflicts with parked vehicles. Traffic Impacts: Improved traffic flow during AM and PM peak periods. Property Impacts: No impact. Parking / Loading: Removal of all on-street parking and loading on Gottingen Street during peak periods only.
<p>Medium Investment: Intermittent Outbound Transit Priority Measures</p>	 <ul style="list-style-type: none"> Installation of transit queue jump lanes at key locations; Installation of pedestrian half signals at key pedestrian crossings; 	<ul style="list-style-type: none"> Transit Service: Transit priority at key locations provide moderate service improvement. Walking: Minimal impact. The addition of signalized crosswalks improves street crossing experience. Bicycling: Minimal impact. Fewer conflicts with parked vehicles. Traffic Impacts: Improved traffic flow during AM and PM peak periods. Property Impacts: No impact. Parking / Loading: Removal of all on-street parking and loading on Gottingen Street during peak periods only.
<p>High Investment: Continuous Outbound Transit Priority Lane</p>	 <ul style="list-style-type: none"> Continuous outbound (northbound) lane for buses only (also permitted for use by right turning vehicles); Installation of pedestrian half signals at key pedestrian crossings; 	<ul style="list-style-type: none"> Transit Service: Continuous bus lane and transit priority lane provides significant service improvement. Walking: Minimal impact. The addition of signalized crosswalks improves street crossing experience. Bicycling: Minimal impact. Fewer conflicts with parked vehicles. Traffic Impacts: Improved traffic flow during AM and PM peak periods. Property Impacts: No impact. Parking / Loading: Full-time removal of all on-street parking and loading on Gottingen Street

Attachment B: Bayers Road Summary and Options Overview

Bayers Road

Due to the varying widths and conditions found along the Bayers Road corridor, for the purposes of this investigation it has been separated into the following three distinct sections (illustrated in Figure 1).

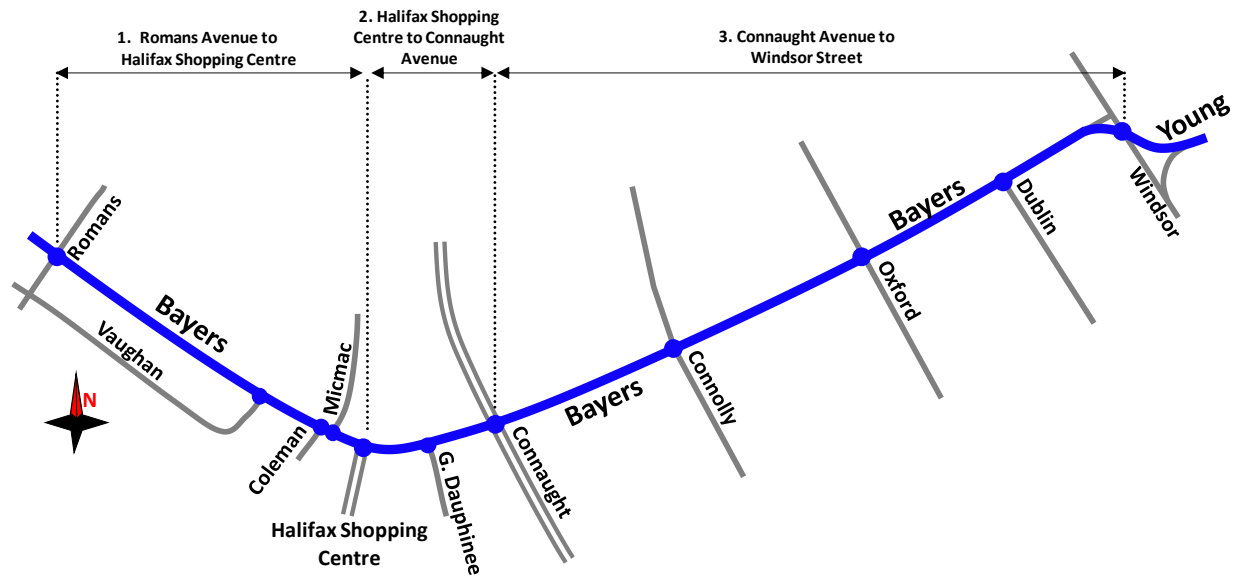

Figure 1: Bayers Road Corridor

Table 1 summarizes existing conditions for the three sections of Bayers Road related to vehicular traffic, active transportation, transit, property ownership, adjacent land uses, and parking / loading.

Table 1: Existing Conditions – Bayers Road Corridor

	Vehicle Traffic	Pedestrians / Cyclists	Transit	Property Ownership	Adjacent Land Uses	Parking and Loading
Romans Avenue to Halifax Shopping Centre	<p>Four lanes (2 lanes each direction) separated by a median</p> <p>Heavy traffic volumes and high delays during AM / PM peak periods</p>	<p><i>Walking:</i> Though there are existing sidewalks, it is not an ideal walking environment due to heavy traffic volumes and a lack of separation between the sidewalk and traffic lanes, which reduces comfort for pedestrians.</p> <p><i>Cycling:</i> Not currently an ideal cycling route due to heavy traffic volumes and lack of dedicated space for bicycles.</p>	<p>Used by routes 2, 17, 80, 81, 2, and 330</p> <p>Currently 20-25 buses (2-way) per hour in the PM peak</p>	<p>HRM owns majority of property on both sides of the street due to long-term corridor preservation efforts.</p>	<p>Residential</p>	<p>No existing designated on-street parking or loading areas</p>
Halifax Shopping Centre to Connaught Avenue	<p>5-6 lanes (including turn lanes to Halifax Shopping Centre)</p> <p>Short separation (approx. 100m) between Shopping Centre intersection and Connaught Avenue results in spillback of queues, causing congestion.</p> <p>Interaction of queues between intersections complicates access to local land uses including Halifax Shopping Centre.</p>	<p><i>Walking:</i> Existing sidewalks and separation from traffic provide good walking environment.</p> <p><i>Cycling:</i> Not currently an ideal cycling route due to heavy traffic volumes and lack of dedicated space for bicycles.</p>	<p>Used by routes 1, 29, 17, 80, 81, 2, and 330</p> <p>Currently 30-35 buses (2-way) per hour in the PM peak</p>	<p>HRM owns the parcel on the northwest corner of the Bayers Road – Connaught Avenue intersection</p>	<p>Primarily commercial</p>	
Connaught Avenue to Windsor Street	<p>Three lanes (2 westbound, 1 eastbound)</p> <p>Heavy traffic volumes and high delays during AM / PM peak periods</p>	<p><i>Walking:</i> Existing sidewalks and separation from traffic provide good walking environment.</p> <p><i>Cycling:</i> Not currently an ideal cycling route due to heavy traffic volumes and lack of dedicated space for bicycles.</p>	<p>Used by routes 1, 17, 80, 81, and 330</p> <p>Currently 25-30 buses (2-way) per hour in the PM peak</p>	<p>Private</p>	<p>Primarily residential with some commercial</p>	

The design options considered for the section of Bayers Road between Romans Avenue and the Halifax Shopping Centre are summarized in Table 2. Further detail and functional design sketches are provided on Page 1 (Attachment C).

Table 2: Design Options – Bayers Road (Romans Avenue to Halifax Shopping Centre)

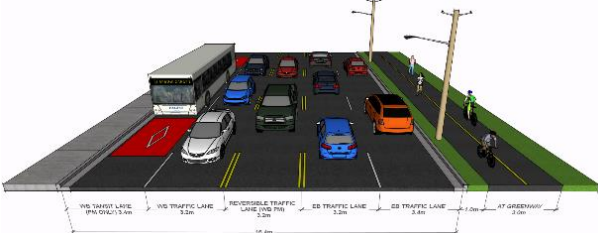
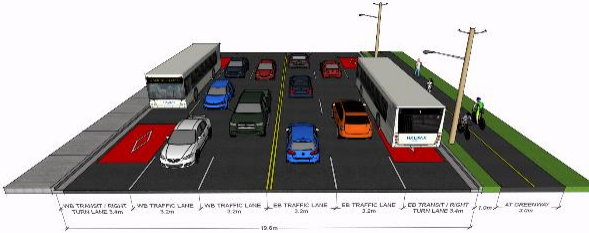
	Description	Summary of Impacts
<p>Medium Investment: Reversible Peak Direction Transit Lane</p>	 <ul style="list-style-type: none"> • Add a reversible dedicated bus lane (also permitted for use by right turning vehicles) that serves eastbound buses before noon and westbound buses after noon; • Requires reversible lane signage and pavement markings, similar to Chebucto Road. • Installation of a multi-use pathway on the south side of Bayers Road; 	<ul style="list-style-type: none"> • Transit Service: Significant transit improvement in the peak direction. Buses can bypass congestion, reducing delay and improving reliability. • Walking: Multi-use path provides increased separation between pedestrians and vehicular traffic. • Bicycling: Multi-use path provides high quality cycling connection, makes an important connection in AT Priorities Plan. • Traffic Impacts: Slight improvement to traffic flow due to removal of buses from general traffic. • Property Impacts: Requires the acquisition of a limited amount of property on the south side of Bayers Road. • Parking / Loading: No impact.
<p>High Investment: Continuous Eastbound and Westbound Transit Lanes</p>	 <ul style="list-style-type: none"> • Add continuous eastbound and westbound dedicated bus lanes (also permitted for use by right turning vehicles); • Installation of a multi-use pathway on the south side of Bayers Road; 	<ul style="list-style-type: none"> • Transit Service: Significant transit improvement in the both directions. Buses can bypass lengthy queues, reducing delay and improving reliability. • Walking: Multi-use path provides increased separation between pedestrians and vehicular traffic. • Bicycling: Multi-use path provides high quality cycling connection, makes an important connection in AT Priorities Plan. • Traffic Impacts: Slight improvement to traffic flow due to removal of buses from general traffic. • Property Impacts: Requires the acquisition of property on the south side of Bayers Road. Marginally more property is required than for the medium investment option. • Parking / Loading: No impact.

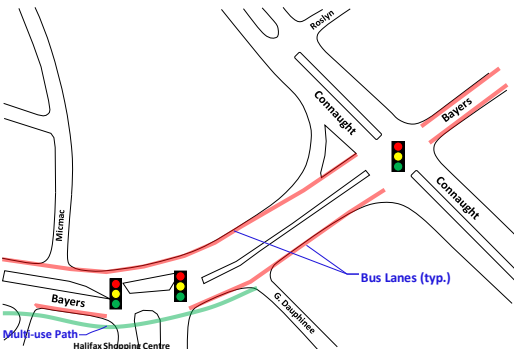
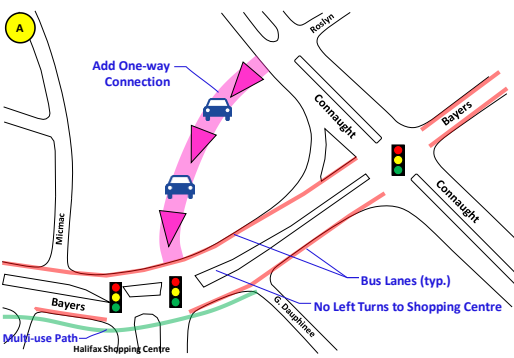
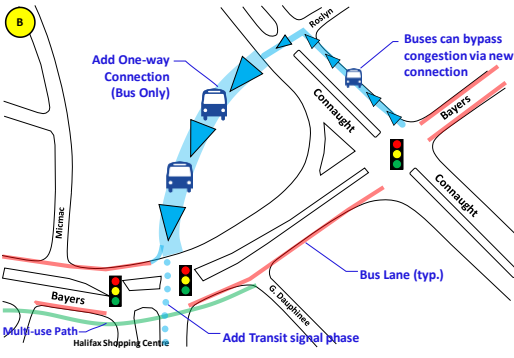
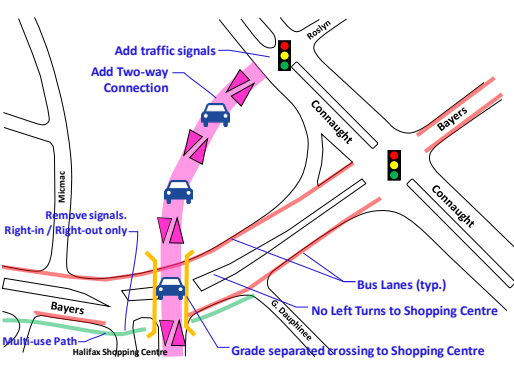

The design options considered for the section of Bayers Road between the Halifax Shopping Centre and Connaught Avenue are summarized in Table 3. Further detail and functional design sketches are provided on Page 2 (Attachment C).

Table 3: Design Options – Bayers Road (Halifax Shopping Centre to Connaught Avenue)

	Functional Sketch	Summary
<p>Low Investment: Dedicated Bus Lanes (Both Directions)</p>		<ul style="list-style-type: none"> • Eastbound and westbound dedicated bus lanes • Property acquisition required on south side of Bayers Road • Improves operation for through buses, but left turns to Halifax Shopping Centre remain a challenge. • Increasing roadway width extends pedestrian crossing distance
<p>Medium Investment: Reconfigured Shopping Centre Intersection with Dedicated Bus Lanes (Both Directions)</p>		<ul style="list-style-type: none"> • Add new one-way driveway connection to Shopping Centre across HRM-owned vacant parcel. • Eastbound and westbound dedicated bus lanes without need to widen Bayers Road. • Left turns into mall prohibited from Bayers Road, removing key source of congestion. New connection provides increased capacity for traffic entering Shopping Centre. • Less direct access for vehicles entering Shopping Centre.
<p>Medium Investment: Reconfigured Shopping Centre Intersection with Dedicated Bus Lanes (Both Directions)</p>		<ul style="list-style-type: none"> • Add new one-way driveway connection to Shopping Centre across HRM-owned vacant parcel <u>for buses only</u>. • Eastbound dedicated bus lane without need to widen Bayers Road. • Westbound buses can bypass congestion via new connection. Buses destined to Shopping Centre divert to new connection and proceed via transit signal phase. • Existing traffic access configuration for Shopping Centre is not impacted.
<p>High Investment: Grade Separated Crossing to Shopping Centre with Dedicated Bus Lanes (Both Directions)</p>		<ul style="list-style-type: none"> • Add new grade separated, two-way connection (bridge) to Shopping Centre across HRM-owned vacant parcel. • Remove signals from Shopping Centre intersections. Add signals to Connaught Avenue – Roslyn Road intersection. • Eastbound and westbound dedicated bus lanes without need to widen Bayers Road. • Less direct access for vehicles entering Shopping Centre, but higher capacity than existing.

The design options considered for the section of Bayers Road between Connaught Avenue and Windsor Street are summarized in Table 4. Further detail and functional design sketches are provided on Pages 3-4 (Attachment C).

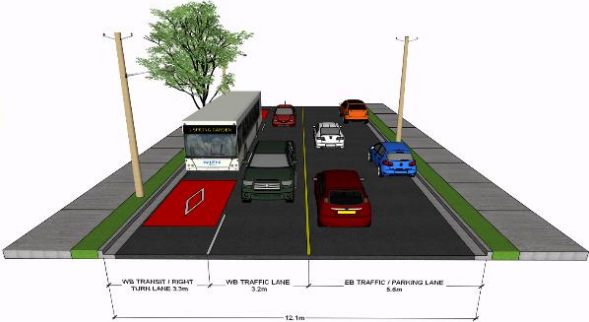
Table 4: Design Options – Bayers Road (Connaught Avenue to Windsor Street)

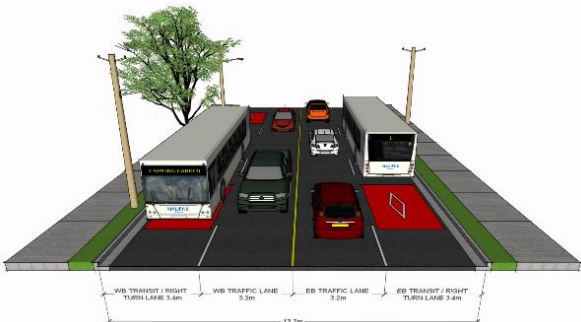
	Description	Summary of Impacts
<p>Low Investment: Westbound Transit Lane</p>	 <ul style="list-style-type: none"> • Continuous westbound dedicated bus lane (also permitted for use by right turning vehicles); 	<ul style="list-style-type: none"> • Transit Service: Significant transit improvement in the westbound direction. Buses can bypass lengthy queues, reducing delay and improving reliability. • Walking: No impact. • Bicycling: No impact. • Traffic Impacts: Loss of one westbound traffic lane; removal of buses from general westbound traffic flow • Property Impacts: No Impact. • Parking / Loading: Modified parking restrictions.
<p>Medium Investment: Reversible Peak Direction Transit Lane</p>	 <ul style="list-style-type: none"> • Reversible dedicated bus lane (also permitted for use by right turning vehicles) that serves eastbound buses before noon and westbound buses after noon; • Requires reversible lane signage and pavement markings, similar to Chebucto Road. 	<ul style="list-style-type: none"> • Transit Service: Significant transit improvement in the peak direction. Buses can bypass lengthy queues, reducing delay and improving reliability. • Walking: No impact. • Bicycling: No impact. • Traffic Impacts: Slight improvement to traffic flow in the peak direction due to removal of buses from general traffic. • Property Impacts: Requires minimal property acquisition, primarily on the south side of Bayers Road. • Parking / Loading: Loss of on-street parking between Connolly Street and Dublin Street.
<p>High Investment: Continuous Eastbound and Westbound Transit Lanes</p>	 <ul style="list-style-type: none"> • Continuous eastbound and westbound dedicated bus lanes (also permitted for use by right turning vehicles); 	<ul style="list-style-type: none"> • Transit Service: Significant transit improvement in the both directions. Buses can bypass lengthy queues, reducing delay and improving reliability. • Walking: No impact. • Bicycling: No impact. • Traffic Impacts: Slight improvement to traffic flow due to removal of buses from general traffic. • Property Impacts: Requires property acquisition, primarily on the south side of Bayers Road. • Parking / Loading: Loss of on-street parking between Connolly Street and Dublin Street.

BAYERS RD. - ROMANS AVE. TO HALIFAX SHOPPING CENTRE

OPTION 1 - HIGH INVESTMENT: DEDICATED BUS LANES (BOTH DIRECTIONS)



	Significant improvements to the flow of public transit.
	No major impacts. Slight improvement to traffic flow expected.
	New 3m off-street AT greenway.
	No impact.
	Impacts to properties along the corridor due to required road widening.

IMPACTS

PROS

- Will significantly improve transit movement in both directions at all times.
- Improves right-turn movement Bayers to Romans.
- Provides new AT greenway.

CONS

- Requires roadway expansion.
- Impacts residential properties along the corridor.

OPTION 2 - MEDIUM INVESTMENT: PEAK DIRECTION 'REVERSIBLE' BUS LANES

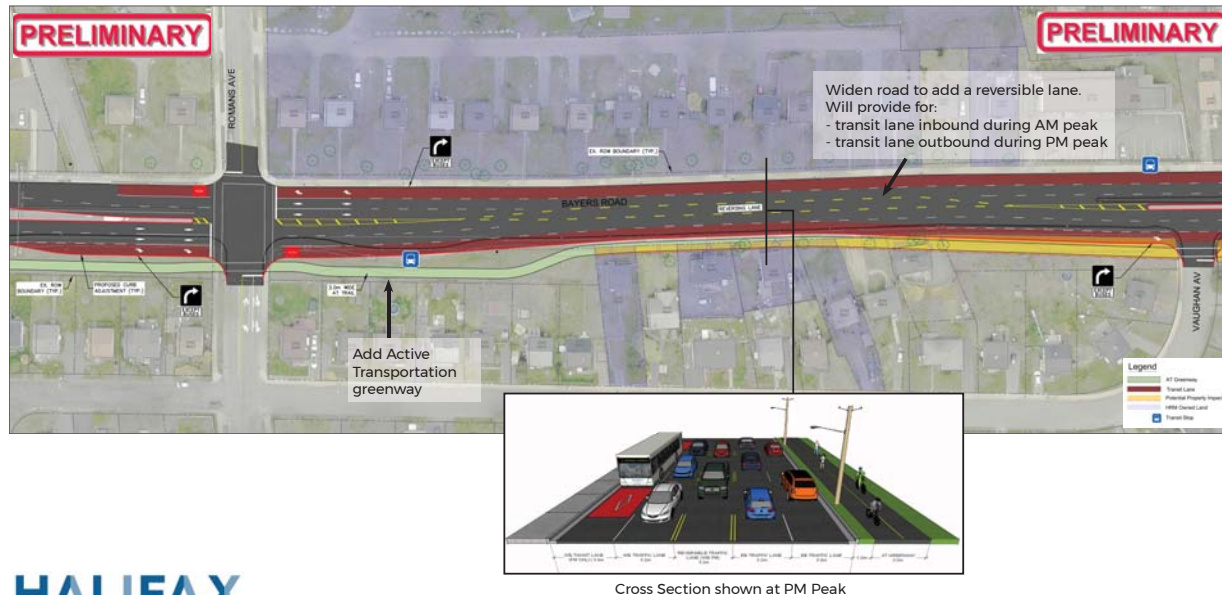

	Improvement to the flow of public transit.
	No major impacts. Slight improvement expected.
	New 3m off-street AT greenway.
	No impact.
	Impacts to properties along the corridor, but to a lesser extent than Option A (due to a reduced widening requirement).

IMPACTS

PROS

- Will improve transit movement in peak direction only.
- Improves right-turn movement Bayers to Romans.
- Provides new AT greenway.
- Lower impacts on adjacent residential properties along the corridor.

CONS

- Requires roadway expansion.
- Only prioritizes transit one way (peak direction).

BAYERS RD. - HALIFAX SHOPPING CENTRE TO CONNAUGHT AVE.

OPTION 1 - HIGH INVESTMENT: MODIFIED HALIFAX SHOPPING CENTRE DRIVEWAY (WITH BRIDGE) AND DEDICATED BUS LANES (BOTH DIRECTIONS)

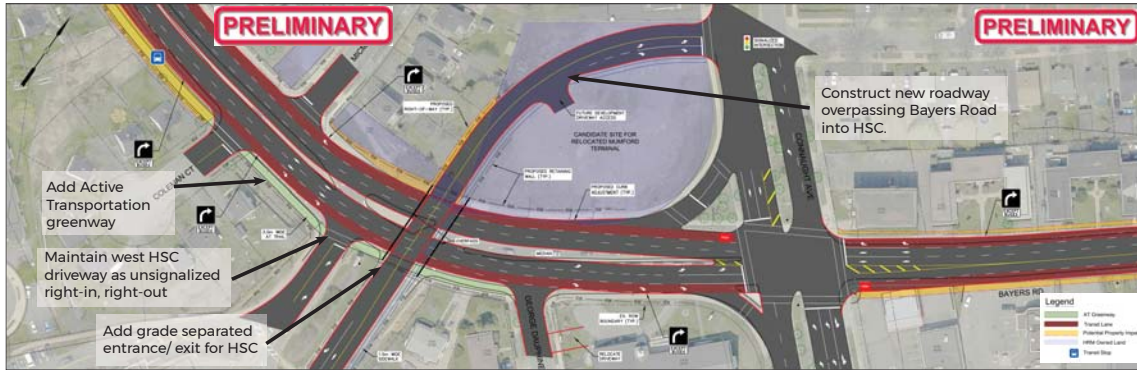

IMPACTS

	Significant improvements to the flow of public transit.
	Significant improvement of traffic flow with removal of HSC signals.
	New 3m off-street AT greenway. Grade separated crossing of Bayers Road.
	No impact.
	Properties will be impacted to allow for roadway adjustments.

PROS

- Will significantly improve transit movement via transit lanes.
- Reduces merging conflicts into Halifax Shopping Centre.
- Alleviates queuing impacts by removing signal at HSC.
- Provides new Active Transportation greenway.

CONS

- High level of investment (cost).
- High level of impact to adjacent properties.
- Prolonged disruption during construction.

OPTION 2 - MEDIUM INVESTMENT: MODIFIED HALIFAX SHOPPING CENTRE DRIVEWAY (REALIGNED INTERSECTION) AND DEDICATED BUS LANES (BOTH DIRECTIONS)

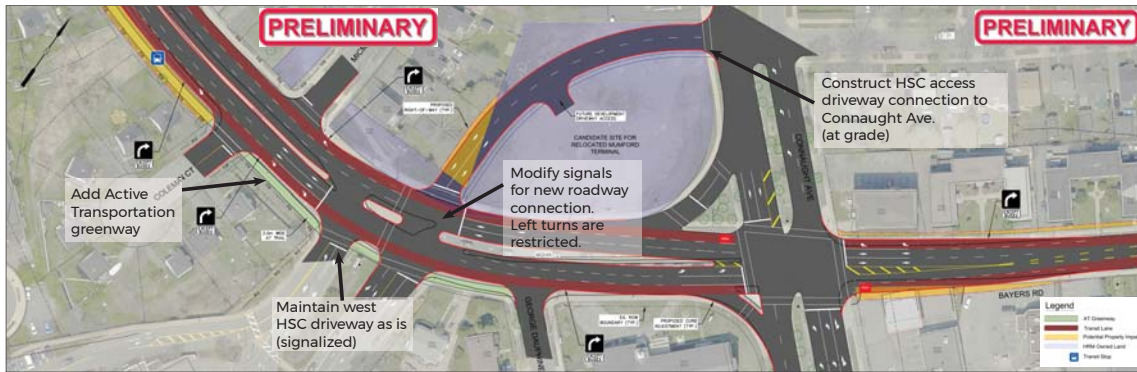

IMPACTS

	Significant improvements to the flow of public transit.
	Improvement of traffic flow with intersection re-alignment.
	New 3m off-street AT greenway.
	No impact.
	Properties will be impacted to allow for roadway adjustments.

PROS

- Will significantly improve transit movement via transit lanes.
- Reduces merging conflicts into HSC.
- Eases through-moving traffic between Connaught and HSC.
- Provides new AT greenway.

CONS

- Maintains close signal spacing along Bayers Road.
- Moderate level of impact to adjacent properties.

OPTION 3 - LOW INVESTMENT: DEDICATED BUS LANES (BOTH DIRECTIONS)

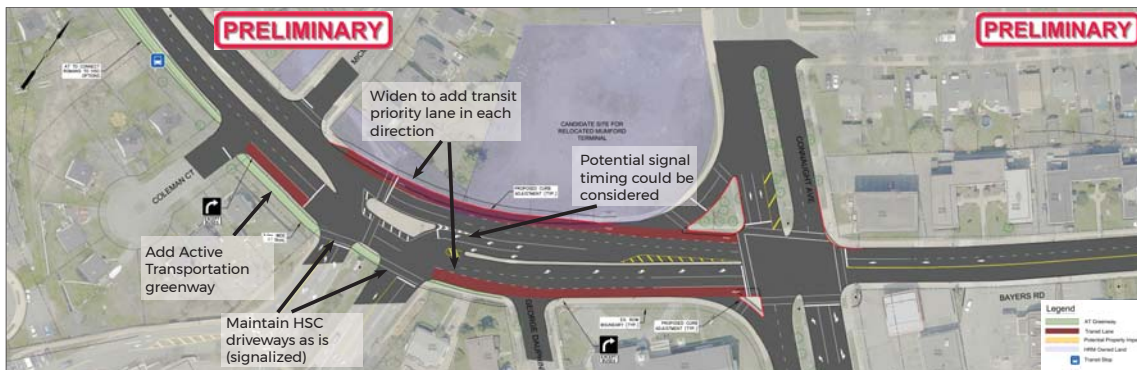

IMPACTS

	Moderate improvements to the flow of public transit.
	No major impacts to traffic flow. Slight improvement expected.
	New 3m off-street AT greenway.
	No impact.
	Slight impacts to properties with AT trail.

PROS

- Will move public transit more effectively than what is currently in place.
- Provides new AT greenway.
- Reduced impacts to adjacent properties.

CONS

- Does not improve transit operations at Connaught Ave. in the outbound direction.
- Will not address queuing and merging issues caused by closely spaced intersections.

BAYERS RD. - CONNAUGHT AVE. TO OXFORD ST.

OPTION 1 - HIGH INVESTMENT: DEDICATED BUS LANES (BOTH DIRECTIONS)

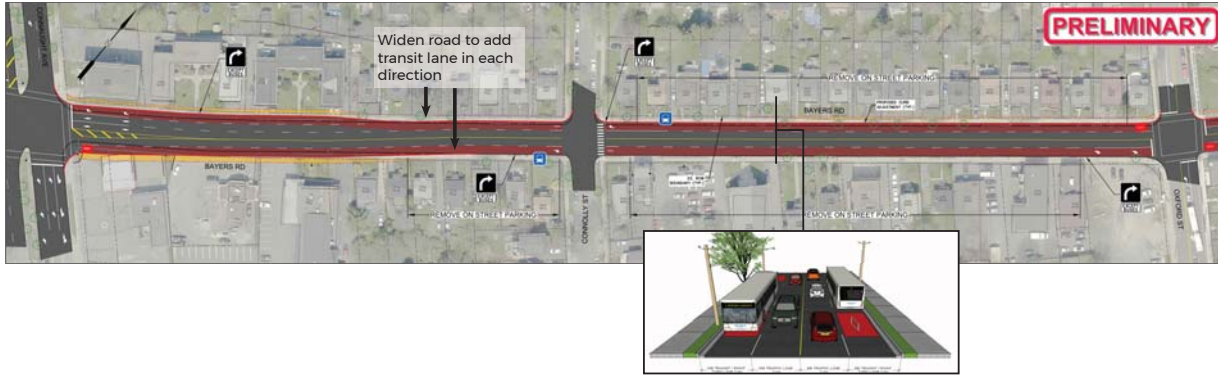

IMPACTS	
Bus	Significant improvements to the flow of public transit inbound and outbound.
Car	Fewer outbound lanes available.
Ped/Bike	No impact.
Parking	Removal of on-street parking.
House	Slight road widening may impact properties along the corridor.

PROS	
•	Will significantly improve transit movement, particularly during PM peak periods.
CONS	
•	Fewer travel lanes for through-moving vehicles on Bayers Road.
•	Road widening is required and may impact properties along the corridor.
•	Removal of on-street parking

OPTION 2 - MEDIUM INVESTMENT: PEAK DIRECTION 'REVERSIBLE' BUS LANES



IMPACTS	
Bus	Improvements to the flow of public transit during peak periods.
Car	Fewer outbound lanes available.
Ped/Bike	No impact
Parking	Removal of on-street parking.
House	No major impacts

PROS	
•	Will improve transit movement in peak directions.
•	Significantly less road widening required (reduction in property impacts).
CONS	
•	Does not benefit transit in off-peak direction.
•	Fewer travel lanes for through-moving vehicles on Bayers Road.
•	Removal of on-street parking

OPTION 3 - LOW INVESTMENT: WESTBOUND (OUTBOUND) DEDICATED BUS LANE



IMPACTS	
Bus	Minimally improves flow of public transit.
Car	Fewer outbound lanes available.
Ped/Bike	No impact
Parking	Modified parking restrictions.
House	No major impact

PROS	
•	No impact to on-street parking and adjacent properties.
CONS	
•	Minimal improvement for public transit relative to existing conditions.
•	Challenges for traffic congestion remain.
•	Potential parking loss.

BAYERS RD. - OXFORD ST. TO WINDSOR ST.

OPTION 1 - HIGH INVESTMENT: DEDICATED BUS LANES (BOTH DIRECTIONS)

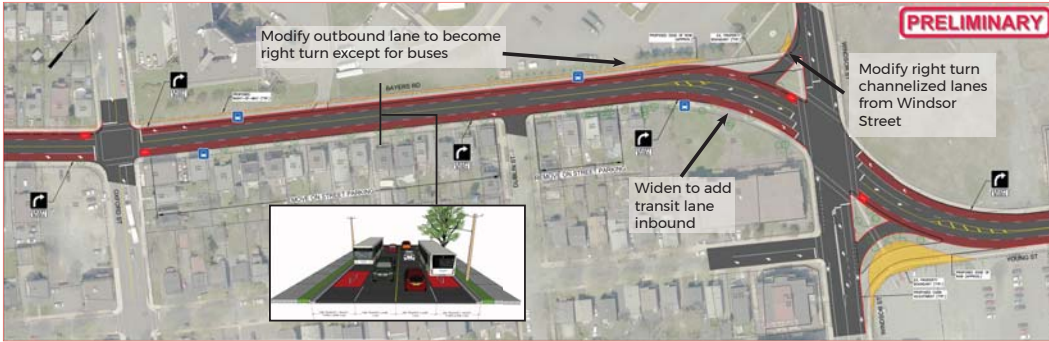

IMPACTS

Significant improvements to the flow of public transit inbound and outbound.
Fewer outbound lanes available for the corridor segment (Windsor to Oxford).
No impact
Reduced time available for on street parking.
Slight road widening may impact properties along the corridor.

PROS

- Will significantly improve transit movement, particularly during PM peak periods.
- Improve right-turn movement from Bayers Rd. to Oxford St. and Bayers Rd. to Windsor St.
- Improves visibility of right-turns at Windsor/ Bayers/ Young intersection.
- More land available at Windsor/Bayers/ Young intersection for streetscaping.

CONS

- Road widening is required and may impact properties along the corridor.
- Fewer travel lanes for through-moving vehicles on Bayers Rd.
- Reduced time available for on-street parking.

OPTION 2 - MEDIUM INVESTMENT: PEAK DIRECTION 'REVERSIBLE' BUS LANES

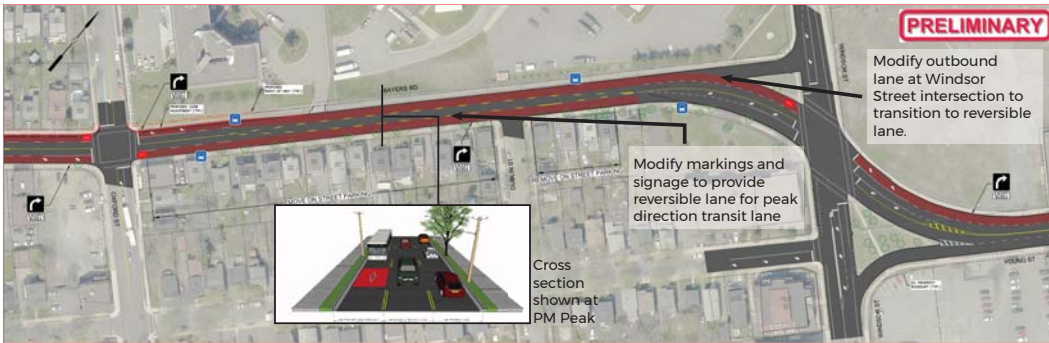

IMPACTS

Improvements to the flow of public transit during peak periods.
Fewer outbound lanes available for the corridor segment (Windsor to Oxford).
No impact
Reduced time available for on street parking.
No major impacts

PROS

- Will significantly improve transit movement, particularly during PM peak periods.
- Improve right-turn movement from Bayers to Oxford during PM peak.
- Significantly less road widening required (reduction in property impacts).

CONS

- Will reduce benefit to transit in off-peak direction.
- Fewer travel lanes for through-moving vehicles on Bayers Road.
- Reduced time available for on street parking.

OPTION 3 - LOW INVESTMENT: WESTBOUND (OUTBOUND) DEDICATED BUS LANE



IMPACTS

Minimally improves flow of public transit.
Fewer outbound lanes available for the corridor segment (Windsor to Oxford).
No impact
Modified parking restrictions.
No impact

PROS

- Will improve transit movement in outbound direction, particularly during PM peak periods.
- Improve right-turn movement from Bayers to Oxford during PM peak.
- No road widening required.
- No on street parking impacts.

CONS

- Minimal improvement for public transit relative to existing conditions.
- Fewer travel lanes for through-moving vehicles on Bayers Road.
- Potential parking loss.

GOTTINGEN ST. - CORNWALLIS ST. TO COGSWELL ST.

OPTION 1 - HIGH INVESTMENT: CONTINUOUS OUTBOUND (NORTHBOUND) TRANSIT PRIORITY LANE

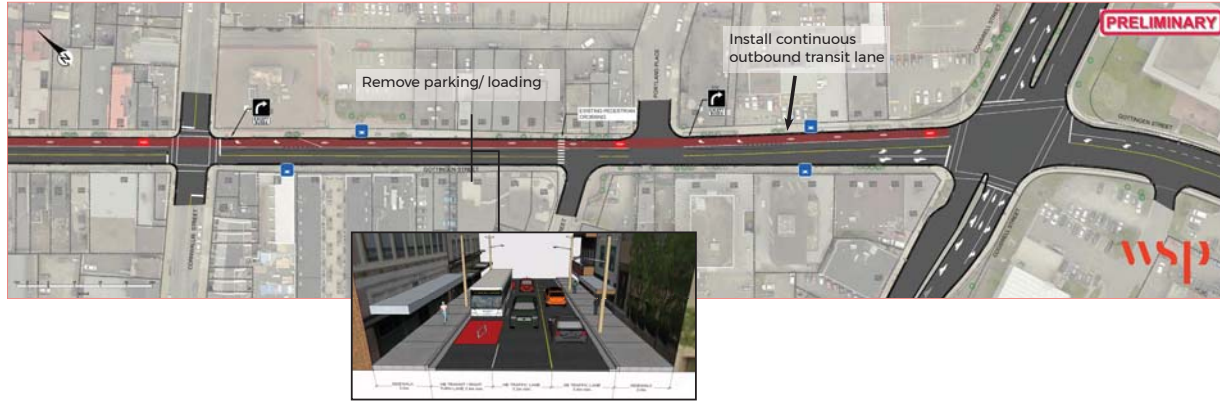

IMPACTS



Improvements to the flow of transit in the outbound (northbound) direction.

Slightly improved traffic flow.

Reduced conflicts with parked vehicles.

No impact.

Full-time loss of parking / loading. Anticipated relocation of some parking / loading to nearby streets.

PROS

- Continuous improvement to transit flow in outbound (northbound) direction.
- Improvement to transit schedule reliability in outbound (northbound) direction.
- High visibility transit priority.
- Potential to increase compliance of parking and loading restrictions.
- Some improvement to the flow of traffic during peak periods.

CONS

- Full-time loss of parking / loading

OPTION 2 - MEDIUM INVESTMENT: INTERMITTENT OUTBOUND (NORTHBOUND) TRANSIT PRIORITY MEASURES

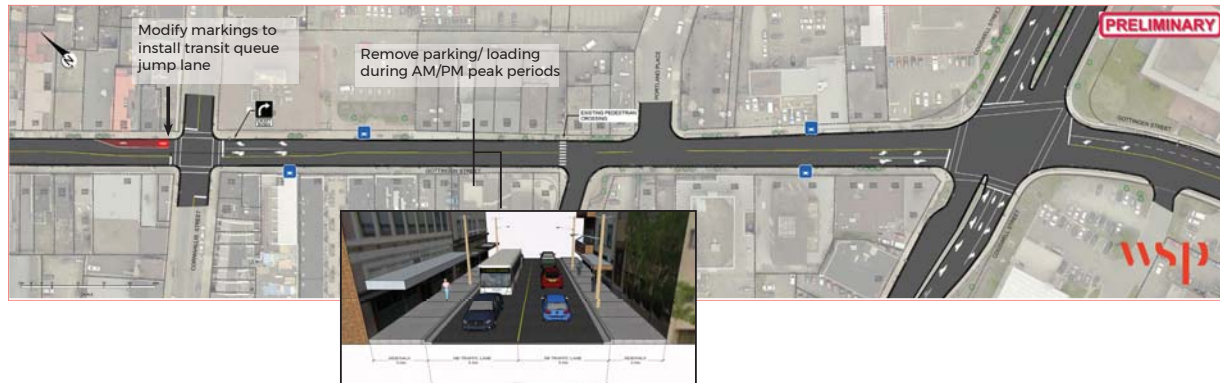

IMPACTS



Slight improvement to the flow of transit in outbound direction.

Slightly improved traffic flow during peak periods.

Reduced conflicts with parked vehicles.

No impact

Loss of parking/loading during peak periods. Anticipated relocation of some parking / loading to nearby streets.

PROS

- Slight improvement to traffic and transit flow during peak periods.
- Some improvement to transit schedule reliability.
- Easy to implement, low cost.

CONS

- Not expected to provide the desired level of transit priority on this busy transit corridor.
- Loss of parking / loading during peak periods.

OPTION 3 - LOW INVESTMENT: PEAK PERIOD PARKING / LOADING / STOPPING RESTRICTIONS



IMPACTS



Slight improvement to the flow of transit during peak periods.

Slightly improved traffic flow during peak periods

Reduced conflicts with parked vehicles.

No impact

Loss of parking/loading during peak periods. Anticipated relocation of some parking / loading to nearby streets.

PROS

- Slight improvement to traffic and transit flow during peak periods.
- Slight improvement to transit schedule reliability during peak periods.
- Easy to implement, low cost.

CONS

- Does not prioritize transit.
- Loss of parking / loading during peak periods.

GOTTINGEN ST. - UNIACKE ST. TO CORNWALLIS ST.

OPTION 1 - HIGH INVESTMENT: CONTINUOUS OUTBOUND (NORTHBOUND) TRANSIT PRIORITY LANE

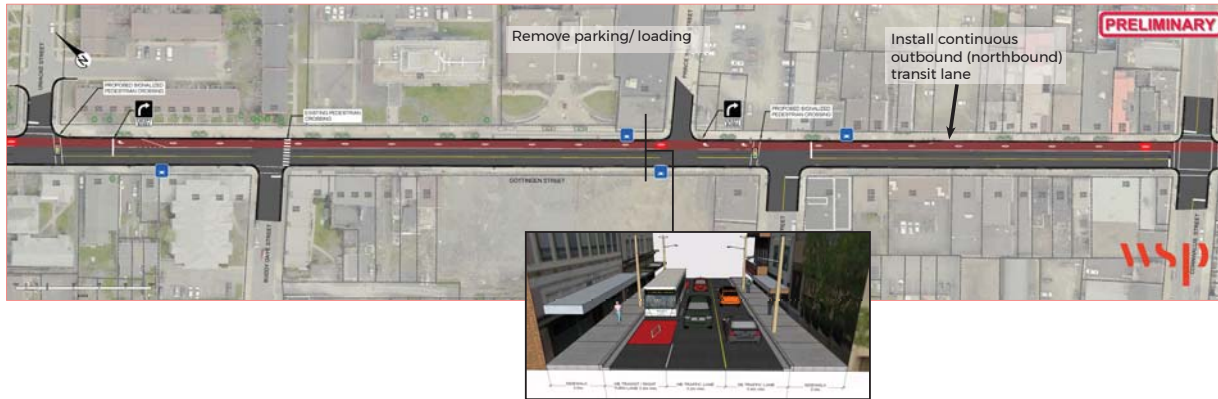

IMPACTS

- Improvements to the flow of transit in the outbound (northbound) direction.
- Slightly improved traffic flow.
- Reduced conflict with parked vehicles.
- Added signalized crossings of Gottingen St. at Cunard St. and Uniacke St.
- Full-time loss of parking / loading. Anticipated relocation of some parking / loading to nearby streets.

PROS

- Continuous improvement to transit flow in outbound (northbound) direction.
- Improvement to transit schedule reliability in outbound direction.
- High visibility transit priority.
- Potential to increase compliance of parking and loading restrictions.
- Signalized crosswalk will provide a higher visible crossing for pedestrians.
- Some improvement to the flow of traffic during peak periods.

CONS

- Full-time Loss of parking / loading

OPTION 2 - MEDIUM INVESTMENT: INTERMITTENT OUTBOUND (NORTHBOUND) TRANSIT PRIORITY MEASURES

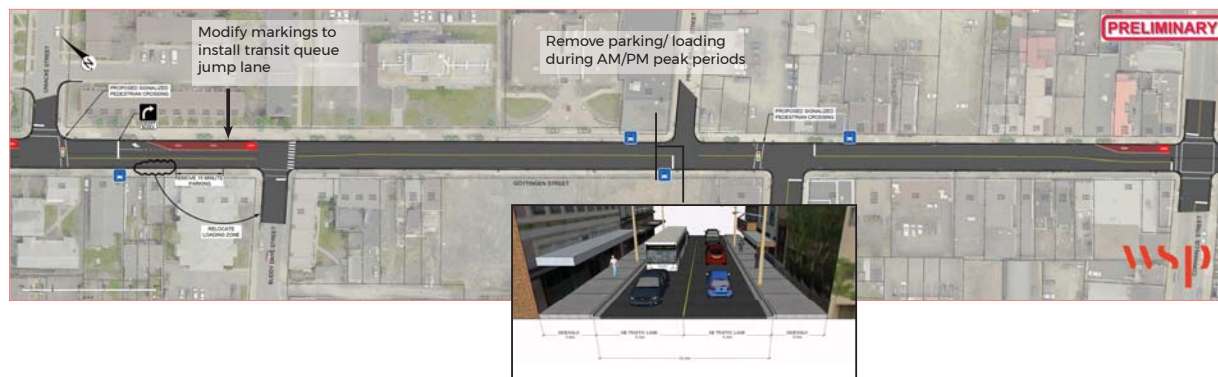

IMPACTS

- Slight improvement to the flow of transit in outbound direction.
- Slightly improved traffic flow during peak periods.
- Reduced conflict with parked vehicles.
- No impact
- Loss of parking/loading during peak periods. Anticipated relocation of some parking / loading to nearby streets.

PROS

- Slight improvement to traffic and transit flow during peak periods.
- Some improvement to transit schedule reliability.
- Easy to implement, low cost.

CONS

- Not expected to provide the desired level of transit priority on this busy transit corridor.
- Loss of parking / loading during peak periods.

OPTION 3 - LOW INVESTMENT: PEAK PERIOD PARKING / LOADING / STOPPING RESTRICTIONS

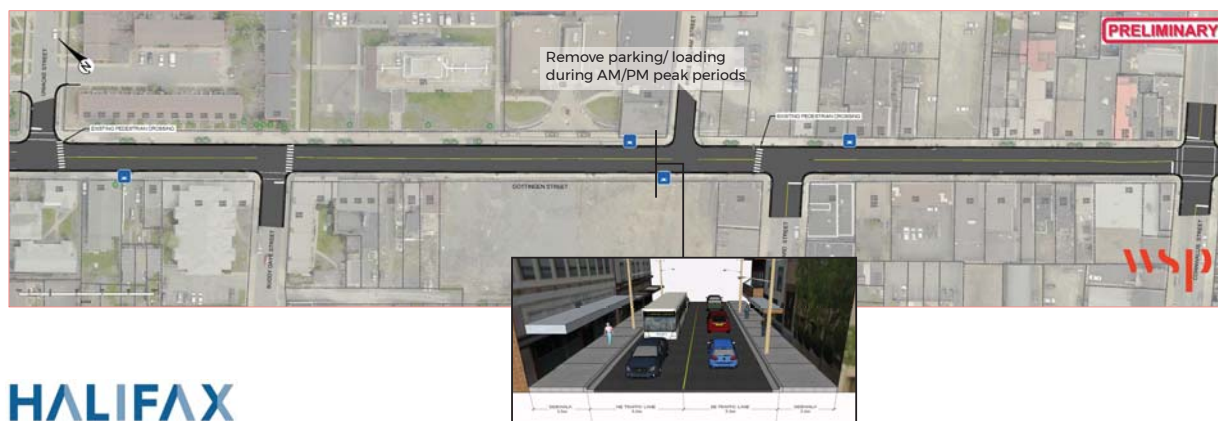

IMPACTS

- Slight improvement to the flow of transit during peak periods.
- Slightly improved traffic flow.
- Reduced conflicts with parked vehicles.
- No impact
- Loss of parking/loading during peak periods. Anticipated relocation of some parking / loading to nearby streets.

PROS

- Slight improvement to traffic and transit flow during peak periods.
- Slight improvement to transit schedule reliability during peak periods.
- Easy to implement, low cost.

CONS

- Does not prioritize transit
- Loss of parking / loading during peak periods

GOTTINGEN ST. - NORTH ST. TO UNIACKE ST.

OPTION 1 - HIGH INVESTMENT: CONTINUOUS OUTBOUND (NORTHBOUND) TRANSIT PRIORITY LANE



IMPACTS	
	Improvements to the flow of transit in the outbound (northbound) direction.
	Impacts right-turn movement toward Macdonald Bridge.
	Reduced conflict with parked vehicles.
	Added signalized crossings of Gottingen St. at Uniacke St.
	Full-time loss of parking / loading. Anticipated relocation of some parking / loading to nearby streets.

- PROS**
- Continuous improvement to transit flow in outbound (northbound) direction.
 - Improvement to transit schedule reliability in outbound direction.
 - High visibility transit priority.
 - Signalized crosswalk will provide a higher visible crossing for pedestrians.
- CONS**
- Full-time Loss of loading.

OPTION 2 - MEDIUM INVESTMENT: INTERMITTENT OUTBOUND (NORTHBOUND) TRANSIT PRIORITY MEASURES



IMPACTS	
	Slight improvement to the flow of transit in outbound (northbound) directions.
	Impacts right-turn movement toward Macdonald Bridge.
	No impact.
	Added signalized crossings of Gottingen St. at Uniacke St.
	No parking on section modified to no stopping during peak periods.

- PROS**
- Slight improvement to traffic and transit flow during peak periods.
 - Some improvement to transit schedule reliability.
 - Easy to implement, low cost
 - Signalized crosswalk will provide a higher visible crossing for pedestrians.
- CONS**
- Not expected to provide the desired level of transit priority on this busy transit corridor.
 - Loss of loading during peak periods.

OPTION 3 - LOW INVESTMENT: PEAK PERIOD PARKING / LOADING / STOPPING RESTRICTIONS



IMPACTS	
	No major impact to this section of Gottingen Street.
	No major impact.
	No impact.
	No impact.
	No parking on section modified to no stopping during peak periods.

- PROS**
- Easy to implement, low cost.
- CONS**
- Does not prioritize transit.
 - Loss of loading during peak periods.

HALIFAX

**Bayers Road /
Gottingen Street
Transit Priority
Corridors**

Public Feedback Survey Summary

October-19-17

Bayers Road

Shape Your City Online Survey	469
Paper Survey	19
Total Participants	488

Bayers Road

How often do you use Bayers Road?

of Responses

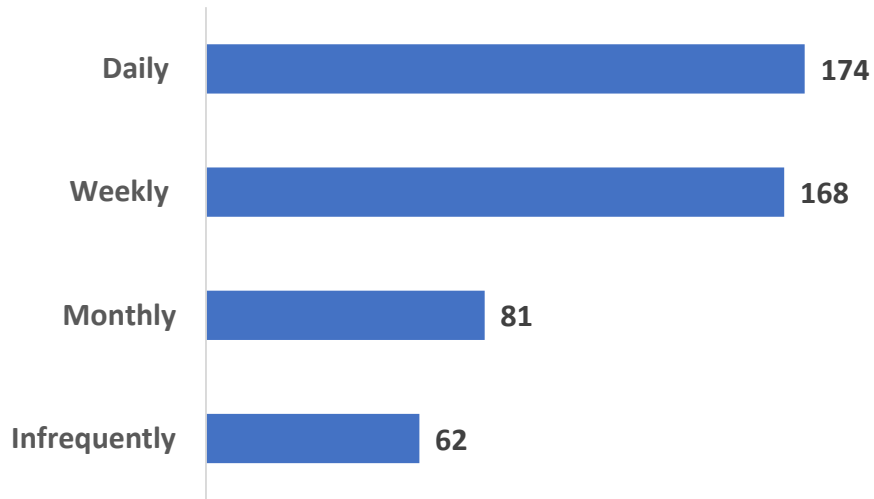

How do you usually travel on Bayers Road?

of Responses

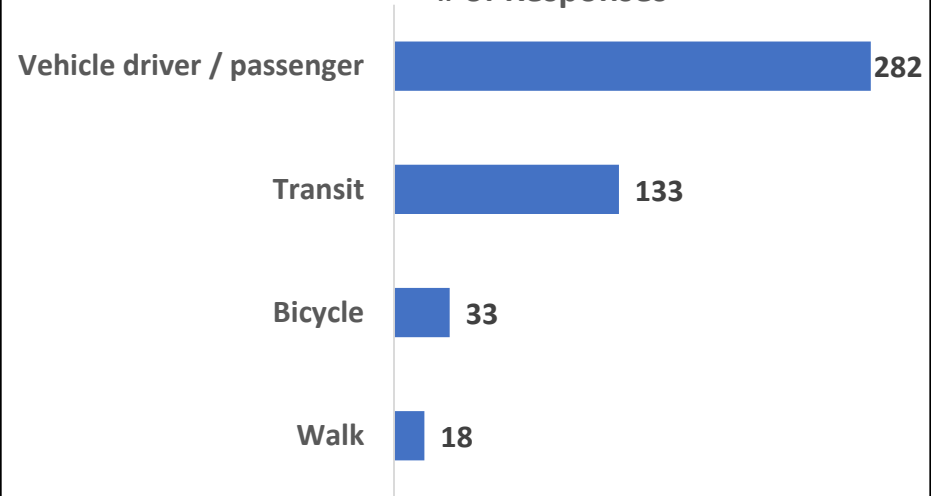

Bayers Road

What matters most to you when you use Bayers Road? (select up to 3)

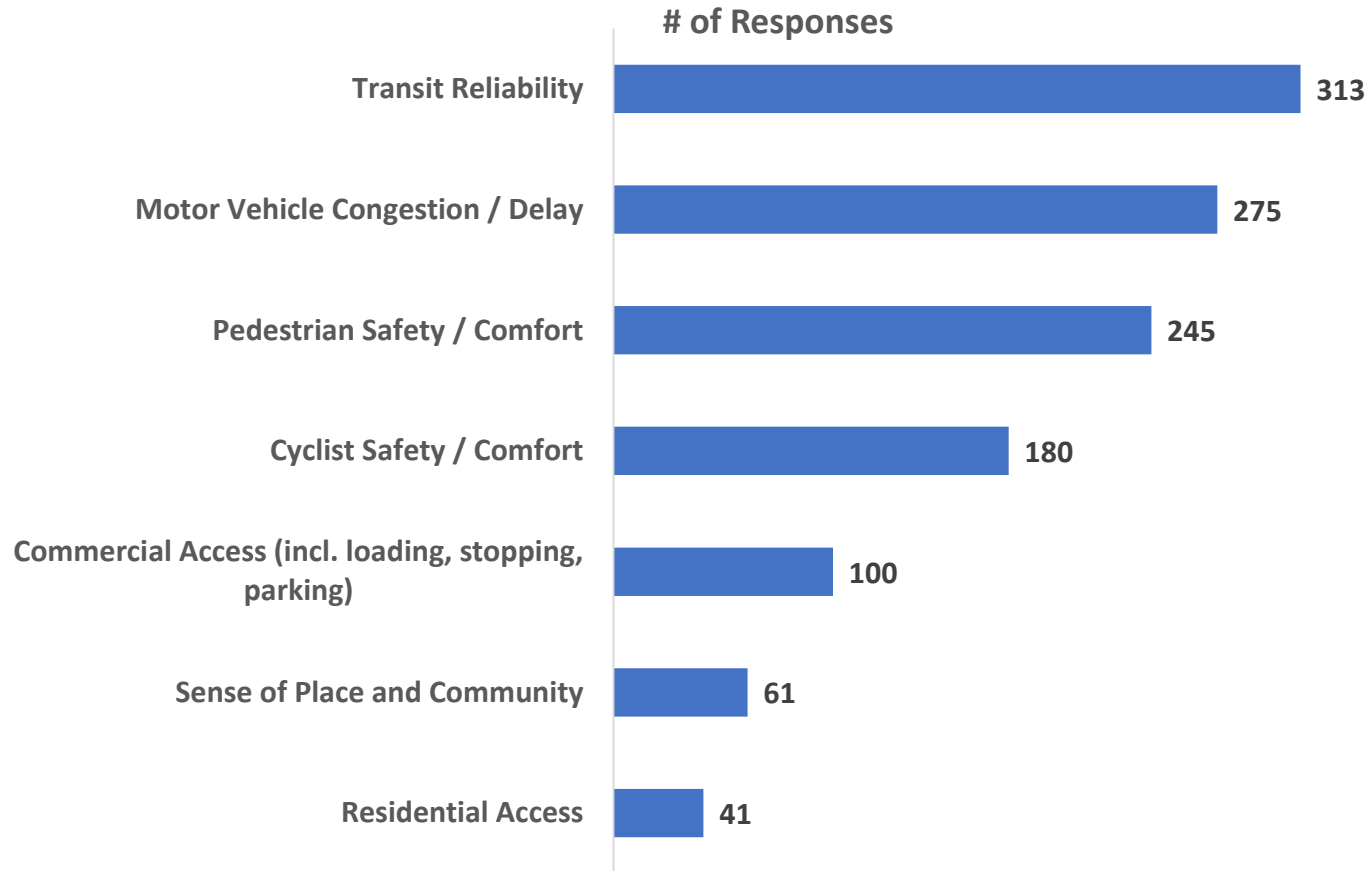

Bayers Road

On a scale from 1-4 (where 1 is poor and four is excellent) how would you rate your experiences on Bayers Road?

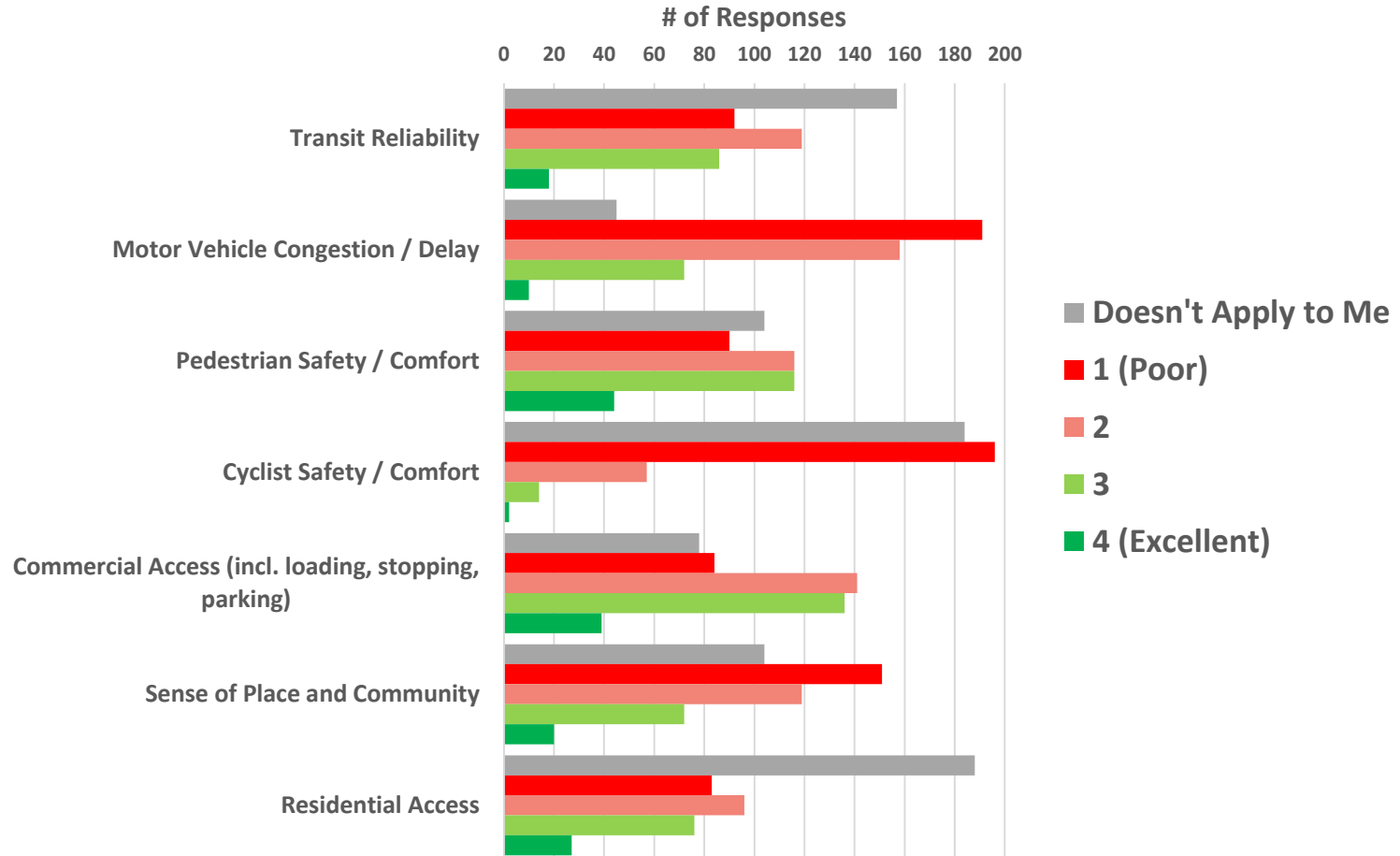

Bayers Road

The addition of transit priority lanes on Bayers Road may require trade-offs in some locations. How acceptable are the following potential trade-offs?

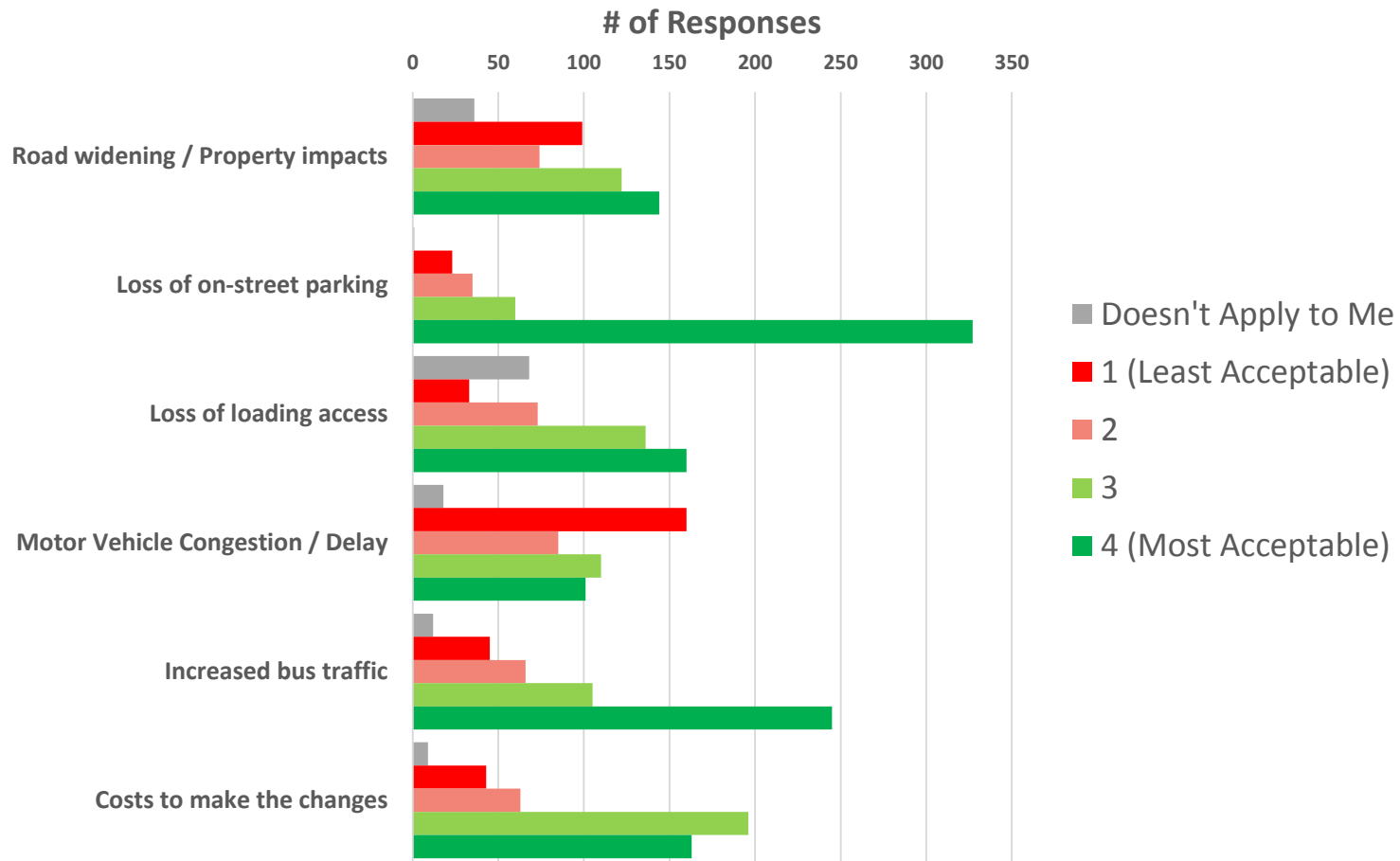

Bayers Road

Section 1 (Romans Ave. to Halifax Shopping Centre):
Indicate your preference based on the presented concepts

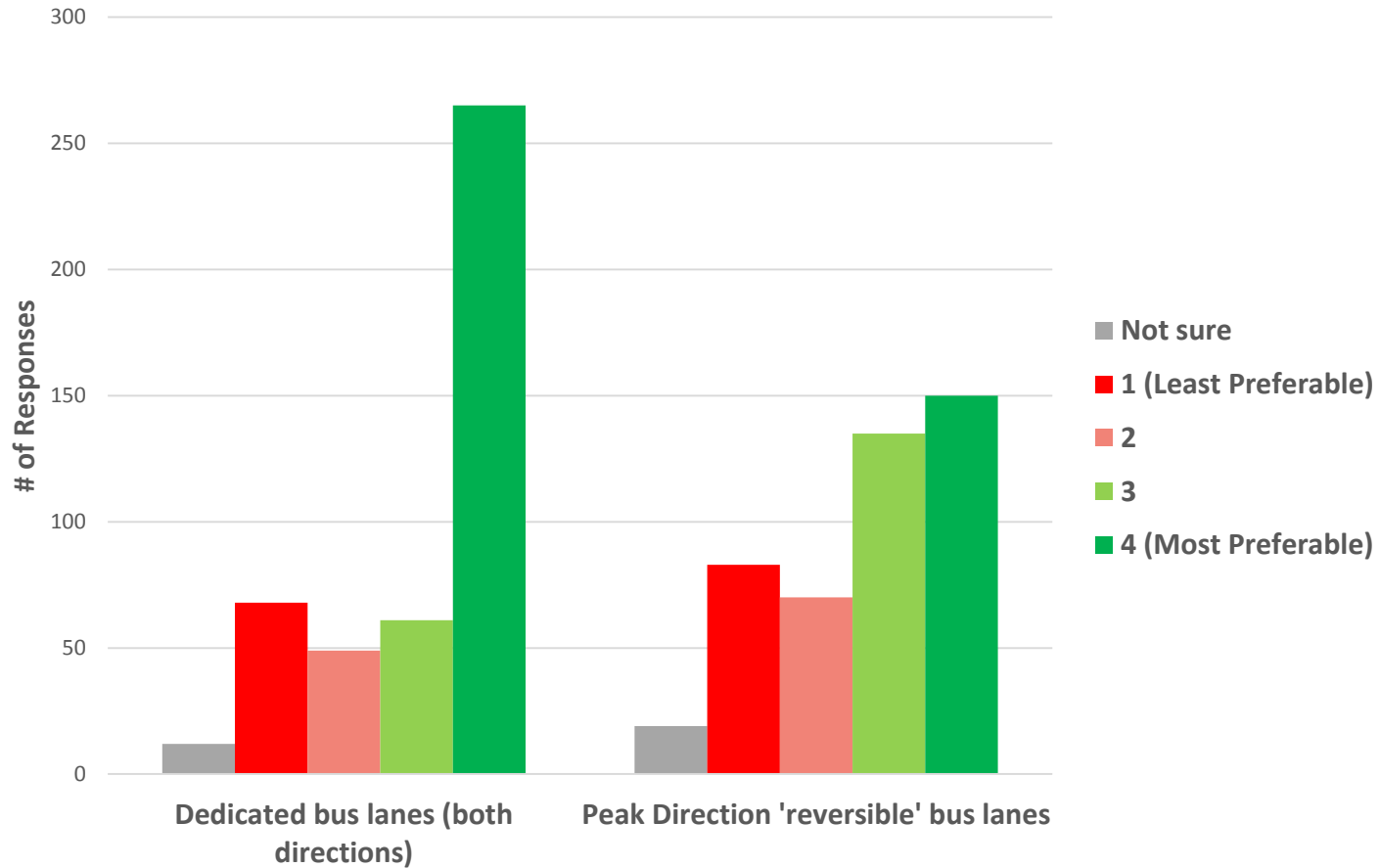

Bayers Road

Section 2 (Halifax Shopping Centre to Connaught Ave.):
Indicate your preference based on the presented concepts

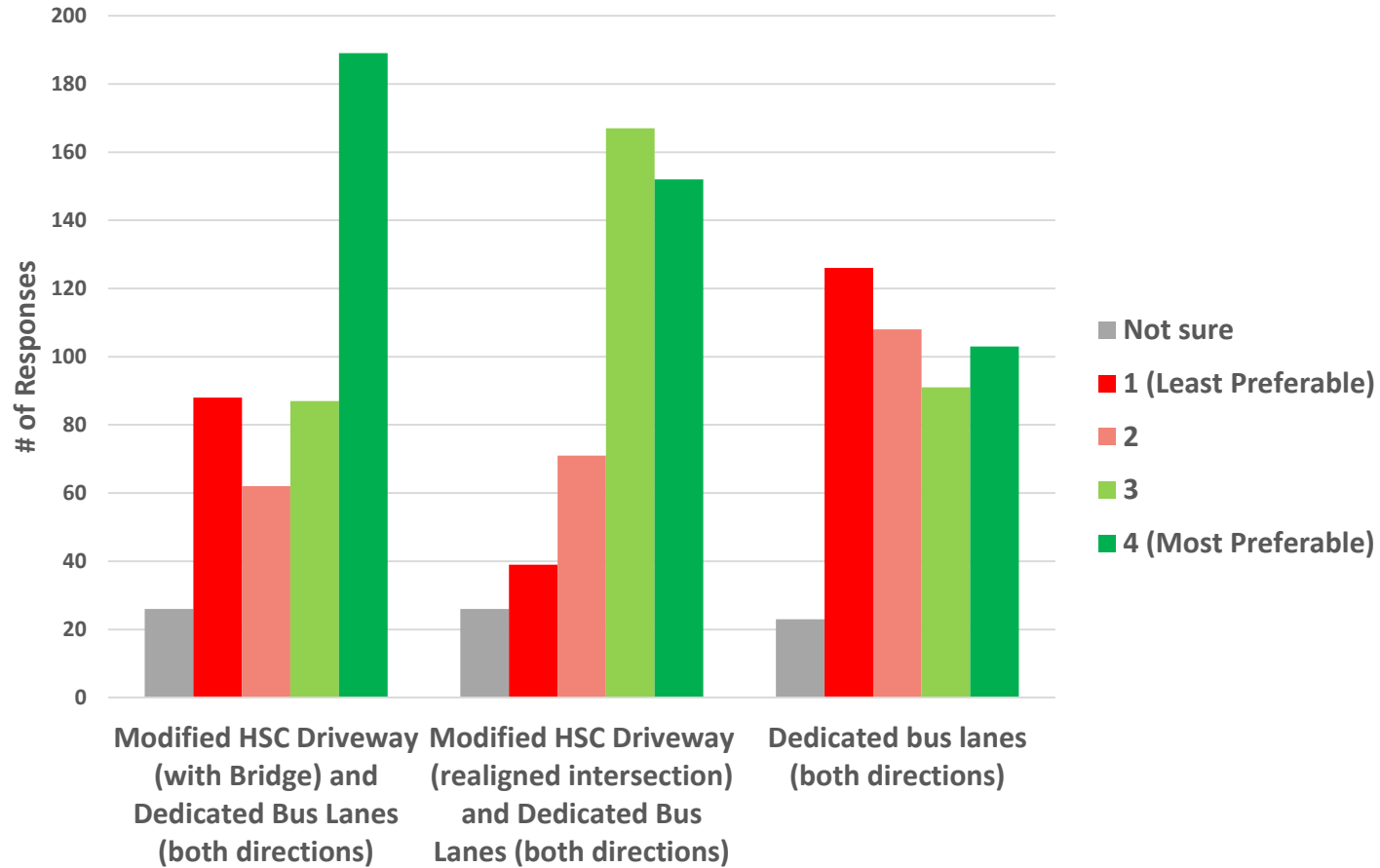

Bayers Road

Section 3 (Connaught Ave. to Connolly Street):
Indicate your preference based on the presented concepts

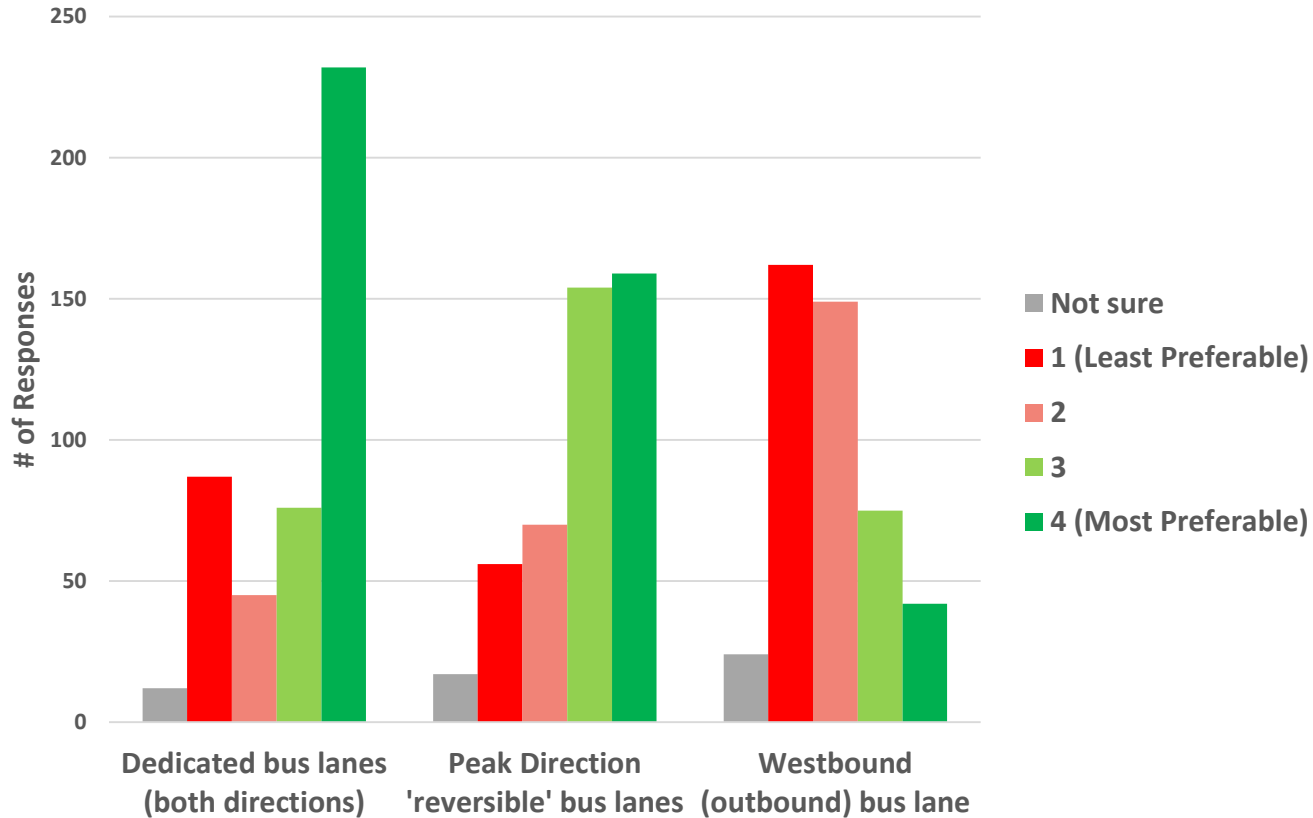

Bayers Road

Section 4 (Connolly Street to Windsor Street):
Indicate your preference based on the presented concepts

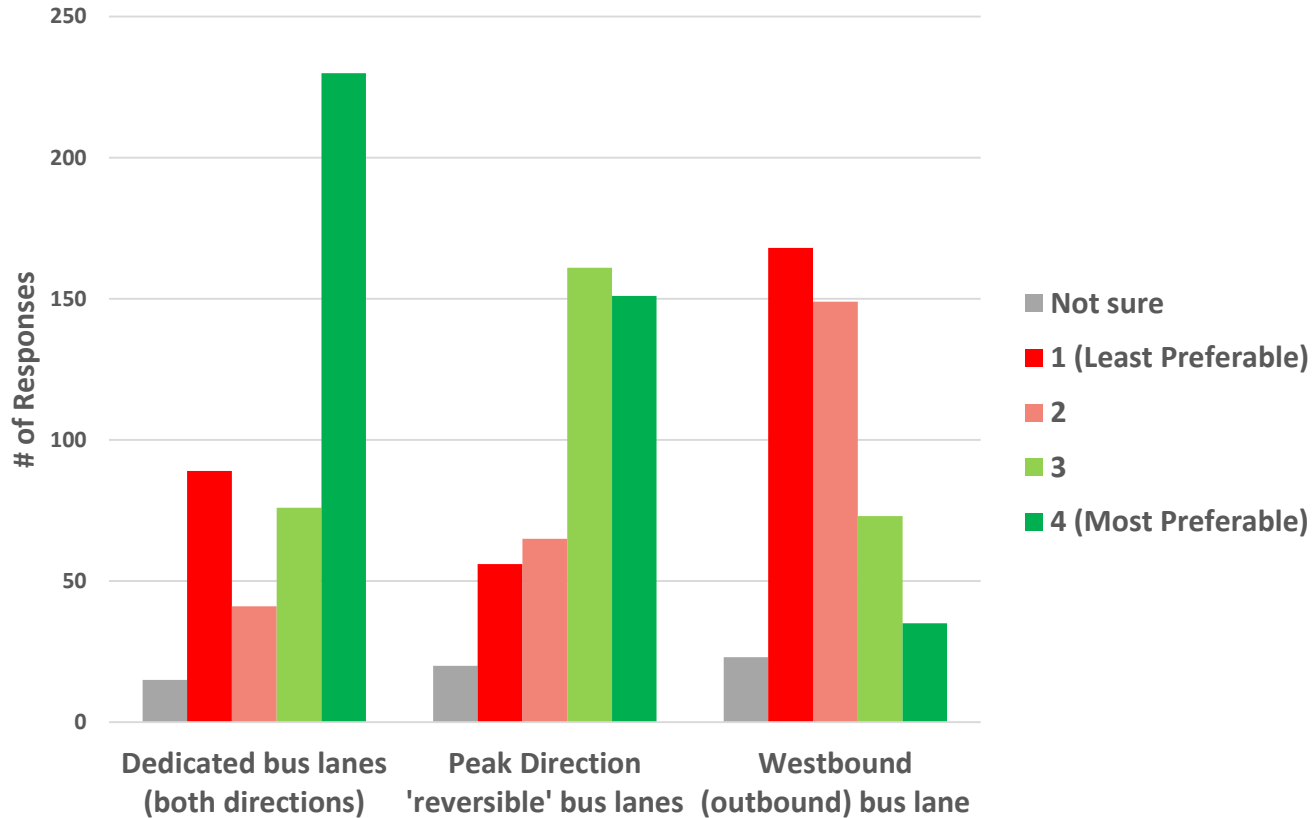

Gottingen Street

Shape Your City Online Survey	273
Paper Survey	23
Total Participants	296

Gottingen Street

How often do you use Gottingen Street?

of Responses

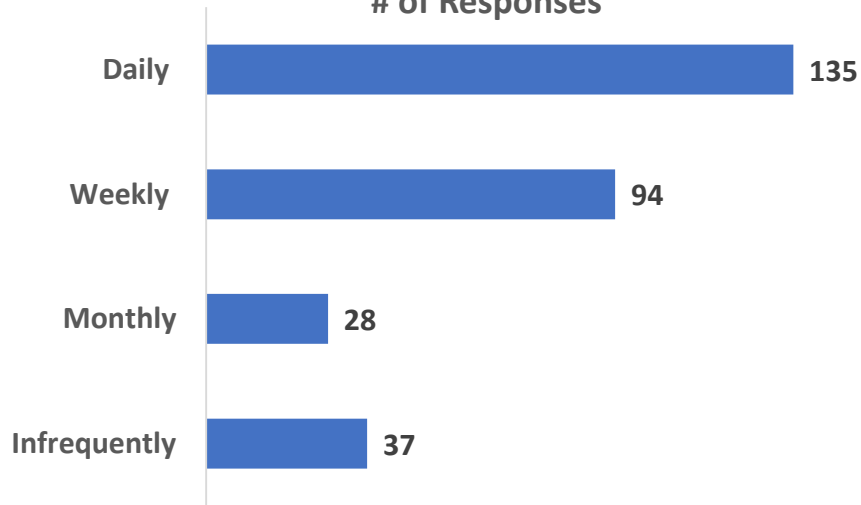

How do you usually travel on Gottingen Street?

of Responses

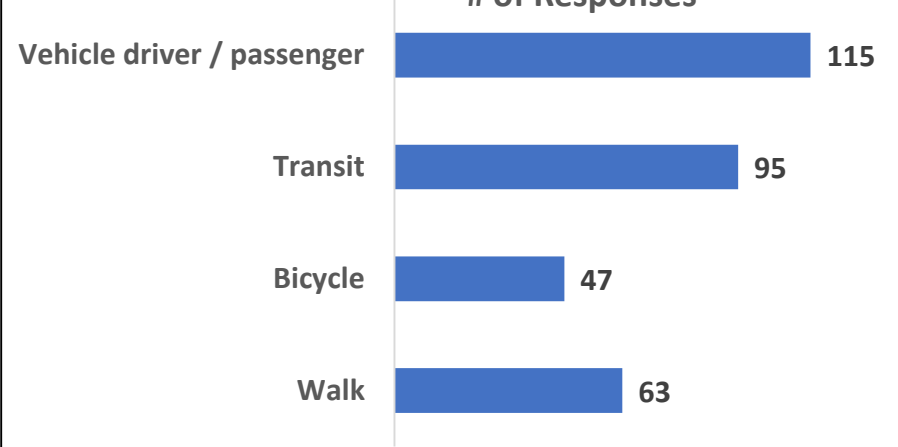

Gottingen Street

What matters most to you when you use Gottingen Street? (select up to 3)

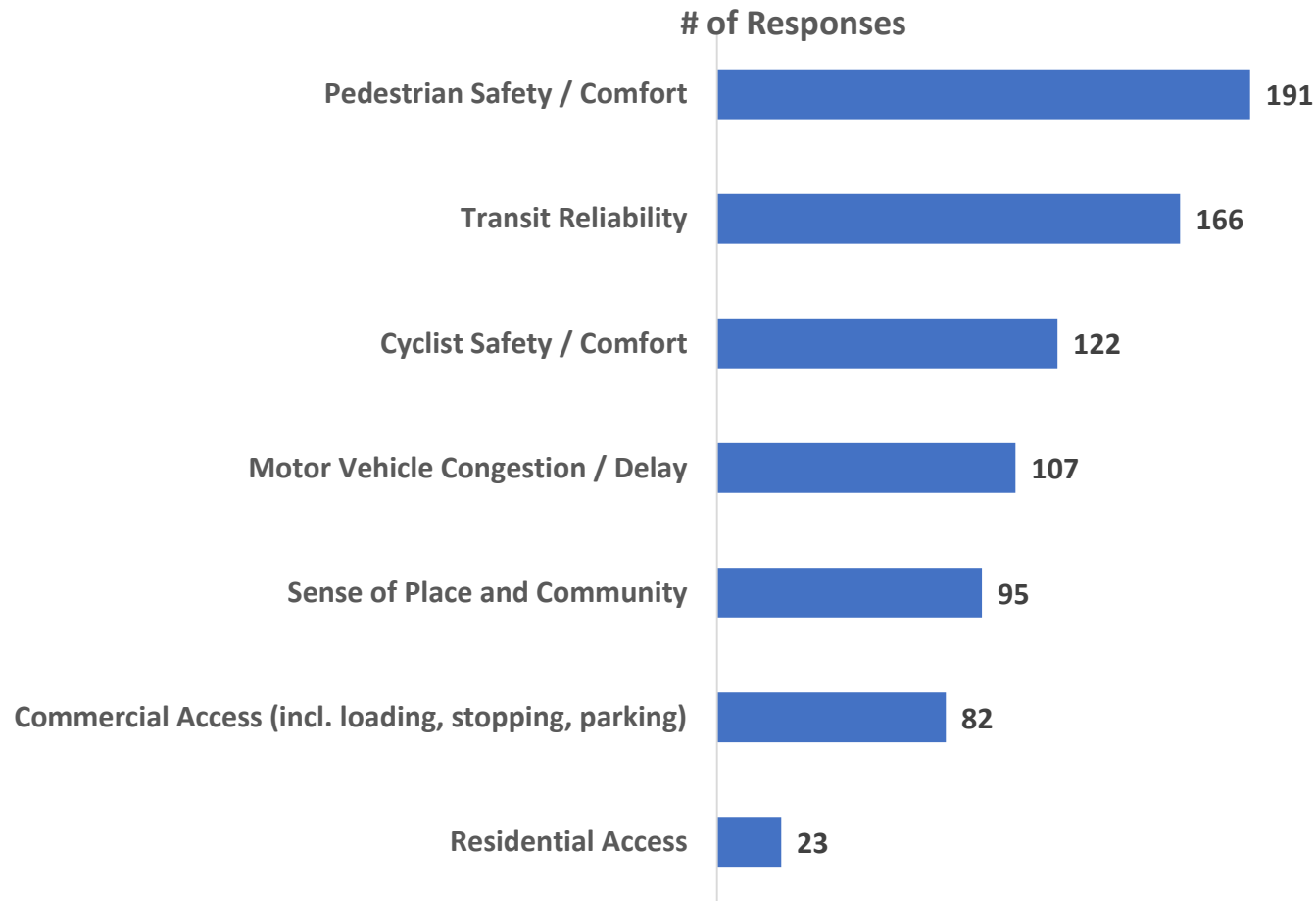

Gottingen Street

On a scale from 1-4 (where 1 is poor and four is excellent) how would you rate your experiences on Gottingen Street?

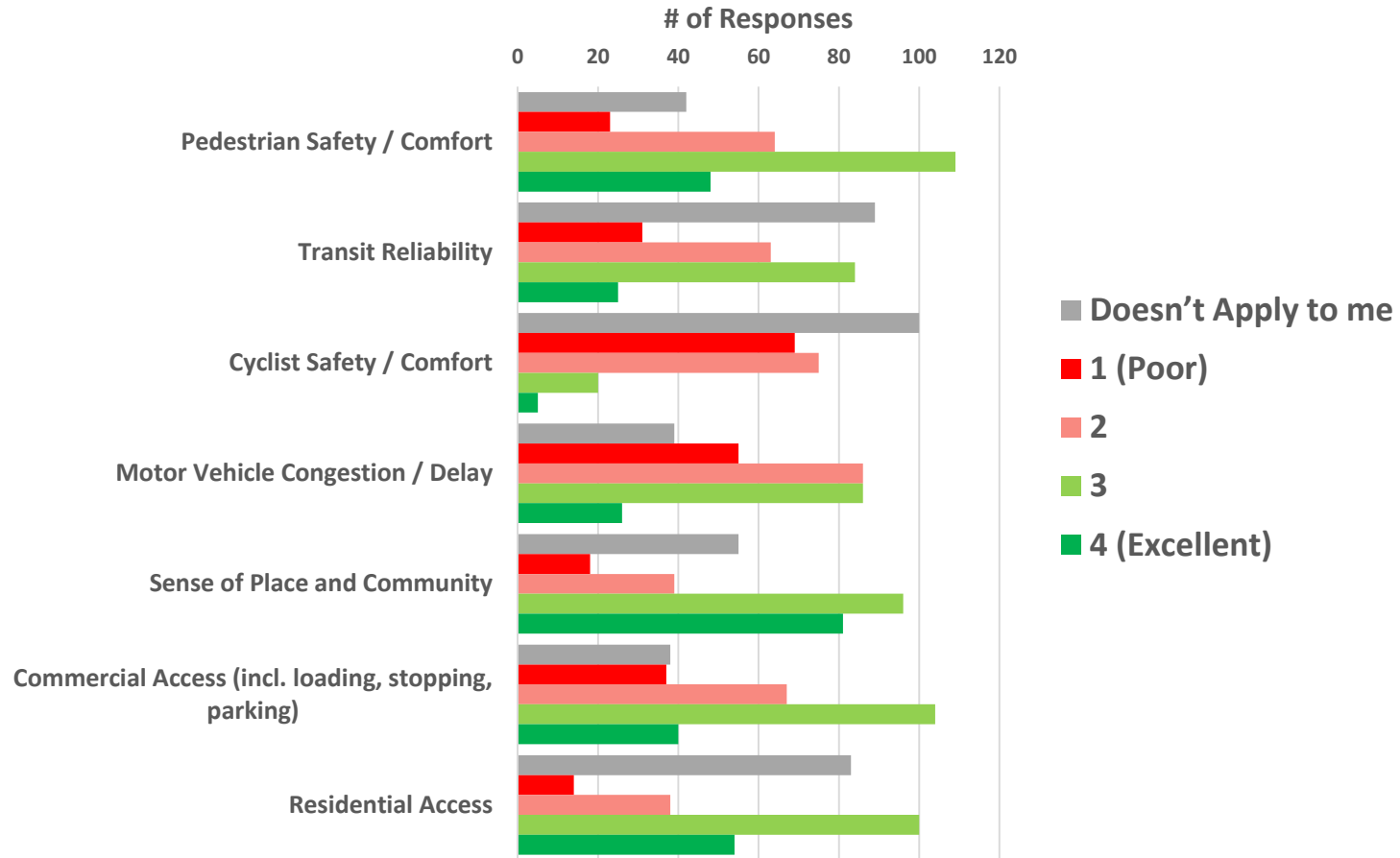

Gottingen Street

The addition of transit priority lanes on Gottingen Street may require trade-offs in some locations. How acceptable are the following potential trade-offs?

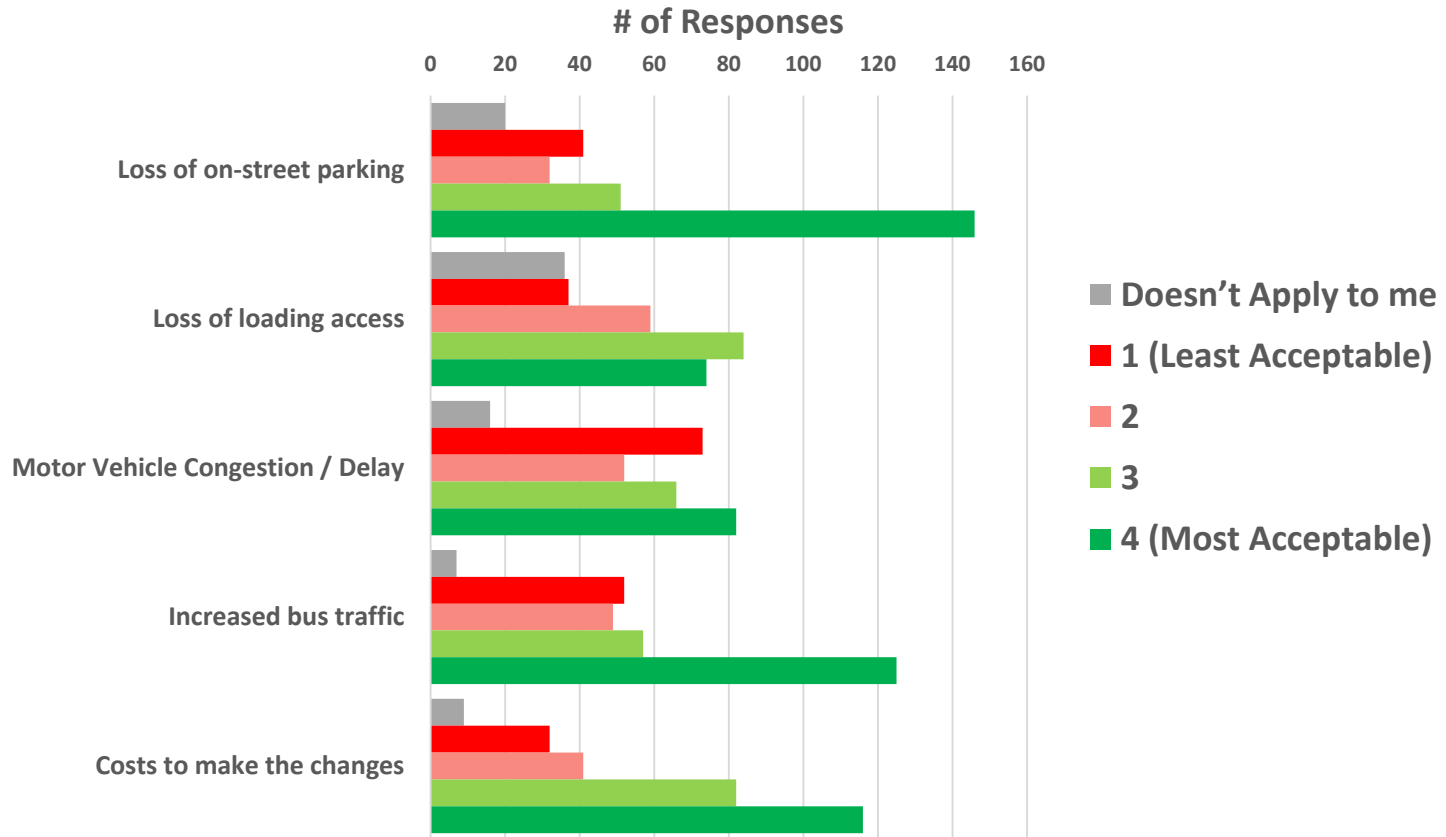

Gottingen Street

Section 1 (Cogswell Street to Cornwallis Street):
Indicate your preference based on the presented concepts

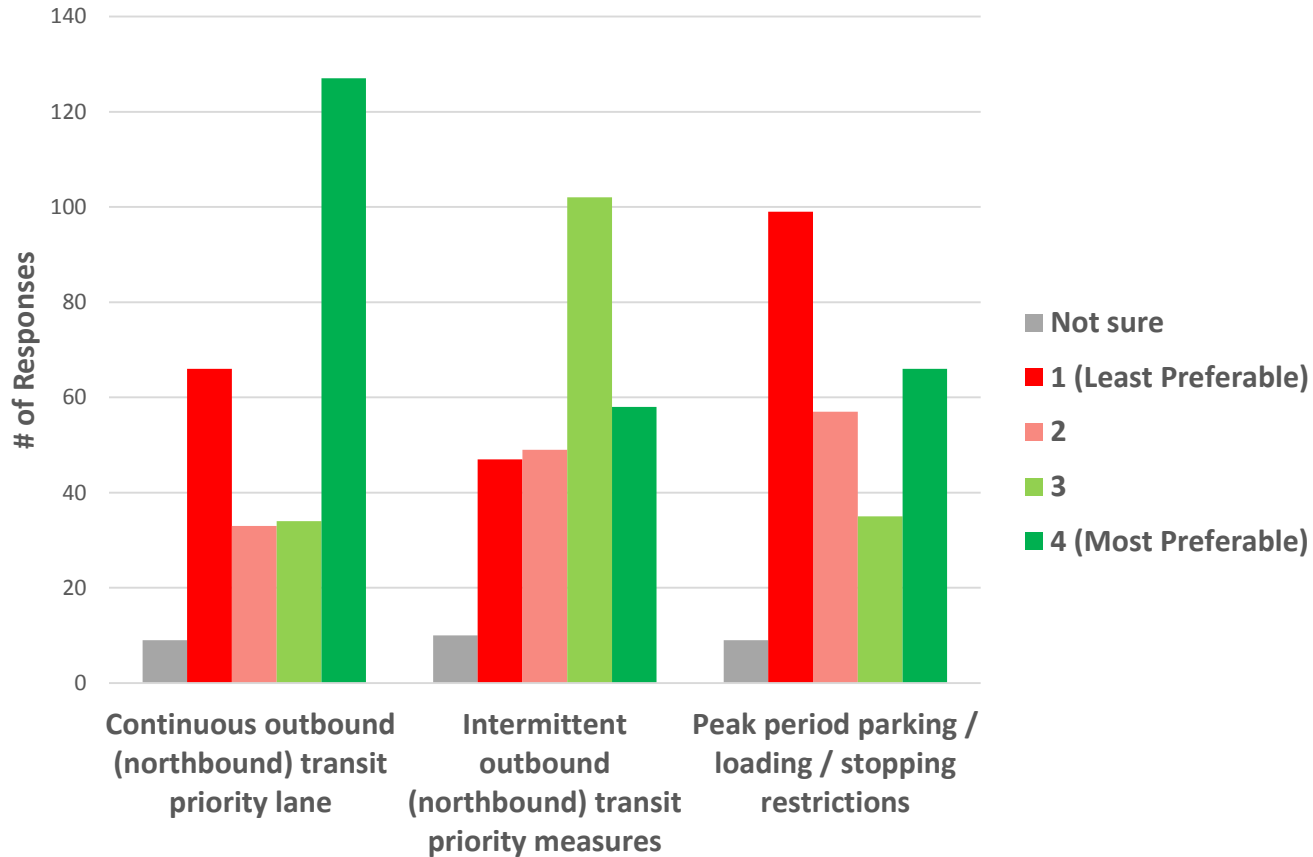

Gottingen Street

Section 2 (Cornwallis Street to Uniacke Street):
Indicate your preference based on the presented concepts

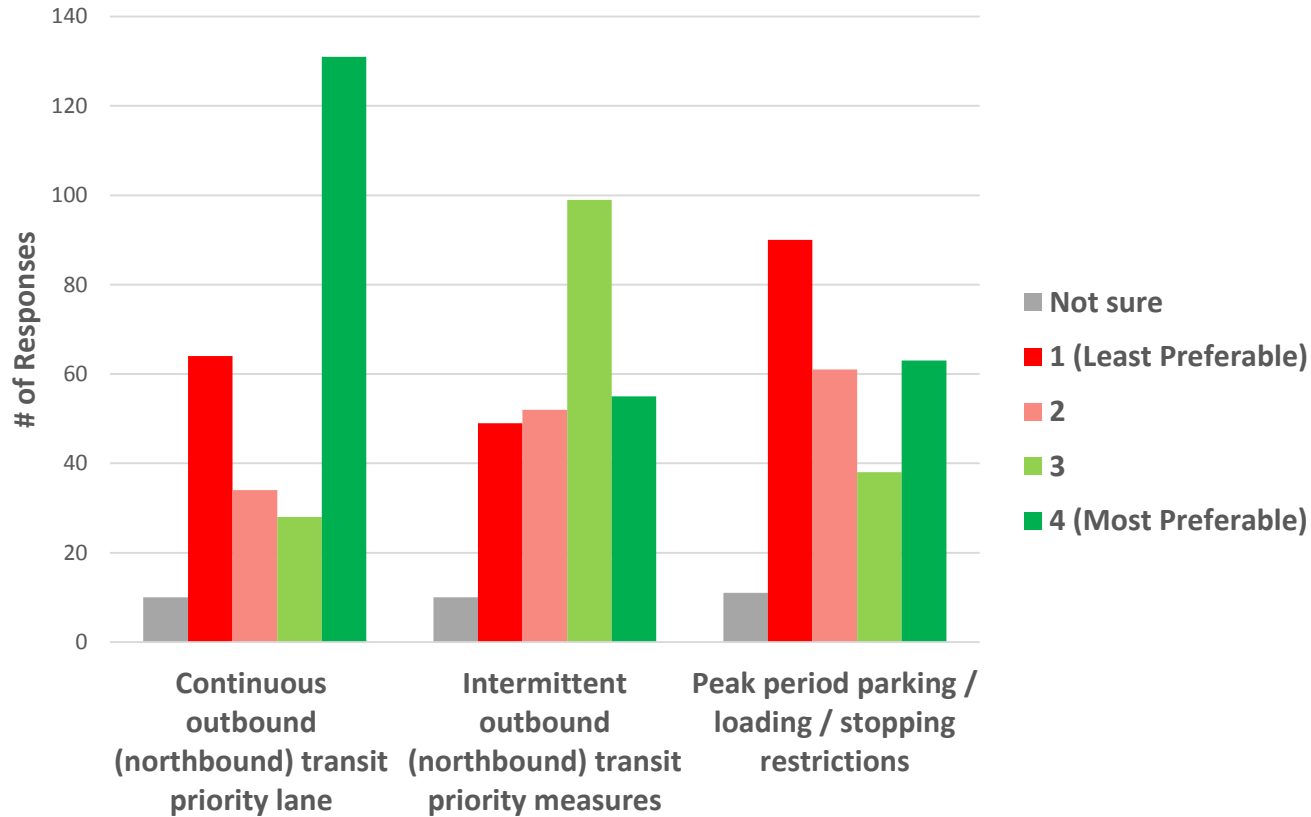

Gottingen Street

Section 3 (Uniacke Street to North Street):
Indicate your preference based on the presented concepts

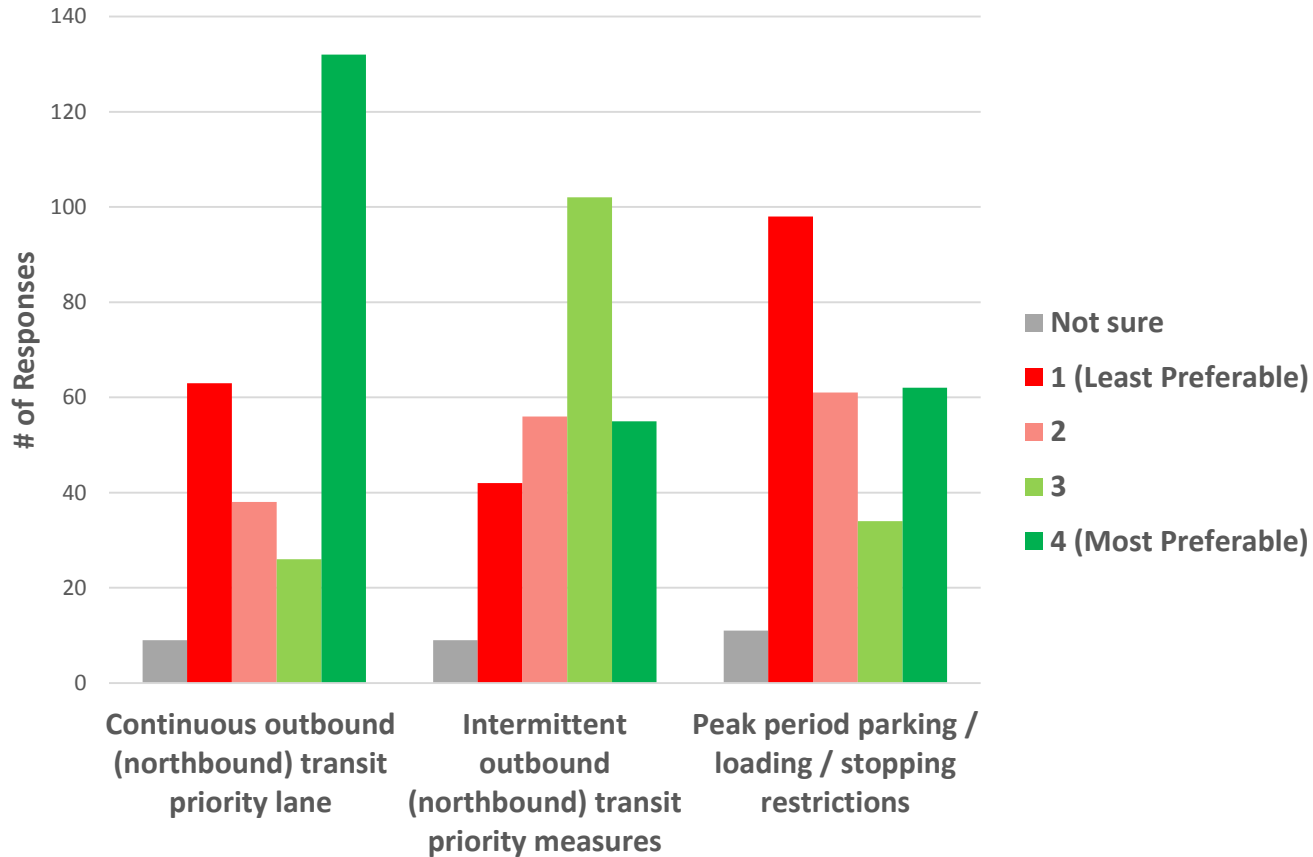

HALIFAX REGIONAL MUNICIPALITY

HALIFAX TRANSIT PRIORITY CORRIDORS – GOTTINGEN STREET AND BAYERS ROAD

JANUARY 2018



Project No. 171-09619



TABLE OF CONTENTS

1	INTRODUCTION AND BACKGROUND.....	1
1.1	Transit	1
1.2	Active Transportation (AT)	1
1.3	Study Area.....	2
1.4	Study Objectives.....	2
2	OVERVIEW OF EXISTING OPERATIONS	3
2.1	Traffic Congestion.....	3
2.2	Data Collection & Review	3
2.2.1	Topographic Survey and GIS data.....	3
2.2.2	Traffic Volumes.....	3
2.2.3	Transit Data	4
2.2.4	Pedestrians and Bicyclists.....	4
2.2.5	Parking.....	4
2.2.6	Road Safety	5
3	PROJECT APPROACH / FRAMEWORK	7
3.1	Design Objectives / Considerations.....	7
3.1.1	Design Workshop.....	7
3.2	Stakeholder & Community Consultation	9
3.2.1	HRM Internal Stakeholders.....	9
3.2.2	External Stakeholder Engagement.....	10
3.2.3	Public Open House	12
3.2.4	Online Consultation	12
3.3	Analysis Framework	13
3.3.1	Vehicular Impacts (Transit and non-transit).....	13
3.3.2	Multimodal Level of Service (MMLOS)	13
3.3.3	Parking / Loading	15
3.3.4	Road Safety	15
3.3.5	Cost Estimates.....	15
3.3.6	Overall Analysis.....	15
4	GOTTINGEN STREET.....	17
4.1	Existing Conditions	17
4.1.1	Existing Transit.....	18
4.1.2	Existing Traffic.....	18
4.1.3	Existing Multimodal Analysis.....	18
4.1.4	Road Safety	18
4.1.5	Existing Parking.....	18
4.2	Gottingen Street Modification Options	19
4.3	Gottingen Street Options Evaluation	20

5	BAYERS ROAD.....	23
5.1	Existing Conditions.....	23
5.1.1	Existing Transit.....	24
5.1.2	Existing Traffic.....	24
5.1.3	Existing Multimodal Analysis.....	25
5.1.4	Road Safety.....	25
5.1.5	Existing Parking.....	25
5.2	Bayers Road Modification Options.....	26
5.2.1	Romans Avenue to Halifax Shopping Centre.....	27
5.2.2	Halifax Shopping Centre (HSC) to Connaught Avenue.....	28
5.2.3	Connaught Avenue to Windsor Street.....	30
5.2.4	Windsor Street Intersection.....	32
5.3	Bayers Options Evaluation.....	33
6	SUMMARY & RECOMMENDATIONS.....	35
6.1	Summary.....	35
6.2	Recommendations.....	36
6.2.1	Recommendations - Gottingen Street.....	36
6.2.2	Recommendations - Bayers Road.....	37

APPENDICES

A	FUNCTIONAL DESIGNS
B	PUBLIC CONSULTATION FEEDBACK FORMS
C	ONLINE CONSULTATION RESULTS
D	COST ESTIMATES
E	SAMPLE DELAY AND PAYBACK CALCULATIONS
F	GOTTINGEN STREET INTERSECTION CAPACITY ANALYSIS
G	BAYERS ROAD INTERSECTION CAPACITY ANALYSIS

1 INTRODUCTION AND BACKGROUND

1.1 TRANSIT

Recent and ongoing policy development efforts have made improvements to Halifax’s transit service a key priority for the Municipality. Specifically, Halifax Transit’s *Moving Forward Together Plan* (adopted by Regional Council in April 2016) includes bold moves that aim to improve transit service levels through increased priority, enhanced reliability, and reduced travel time. The bold moves are being made in support of the following four Council-endorsed ‘*Moving Forward Principles*’:

1. Increase the proportion of resources allocated towards high ridership services.
2. Build a simplified transfer based system.
3. Invest in service quality and reliability.
4. Give transit increased priority in the transportation network.



Among the key initiatives that the Municipality is considering for transit upgrades are Transit Priority Measures (TPMs) – strategically located street and intersection upgrades that provide priority for the movement of buses. TPMs provide opportunities to make notable improvements to transit operation, and can be particularly effective in locations where right-of-way (ROW) constraints limit the ability to implement more dedicated facility options. When used effectively, TPMs can provide significant network benefits to transit operation that can stem from time savings of as little as a few seconds at a time.

Building on HRM’s recent success of implementing TPMs at various locations, the Municipality is interested in investigating corridor-level transit priority upgrades that satisfy specific recommendations of the *Moving Forward Together Plan* including two “critical locations” that were identified for transit priority measures: **Bayers Road** and **Gottingen Street**. In particular it has indicated an “urgent need for Transit Priority Measures in the Bayers Road corridor in order to provide reliable service to transit users.”

1.2 ACTIVE TRANSPORTATION (AT)

Active Transportation Connection Study (WSP, 2016) identified alternatives for a multi-use AT facility that would provide a formal connection between the COLT (at Joseph Howe Drive) and George Dauphinee Avenue. That report recommended an offstreet AT greenway on the south side of Bayers Road be provided but identified complications with right-of-way requirements and the signalized crossings of the Halifax Shopping Centre Driveways.

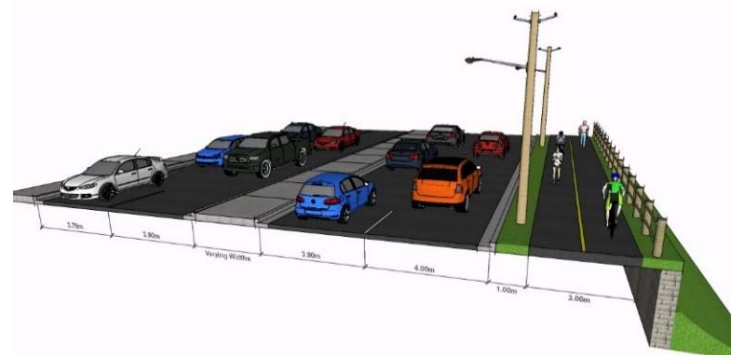

At the outset of this current study, HRM staff requested that consideration of an offstreet greenway south of Bayers Road between the study limits at Romans Avenue and George Dauphinee Avenue be included in the functional designs for all options through this segment.

1.3 STUDY AREA

The Study Area for this project includes the following corridors (shown in Figure 1-1):

1. Gottingen Street: North Street to Cogswell Street; and,
2. Bayers Road: Romans Avenue to Windsor Street.

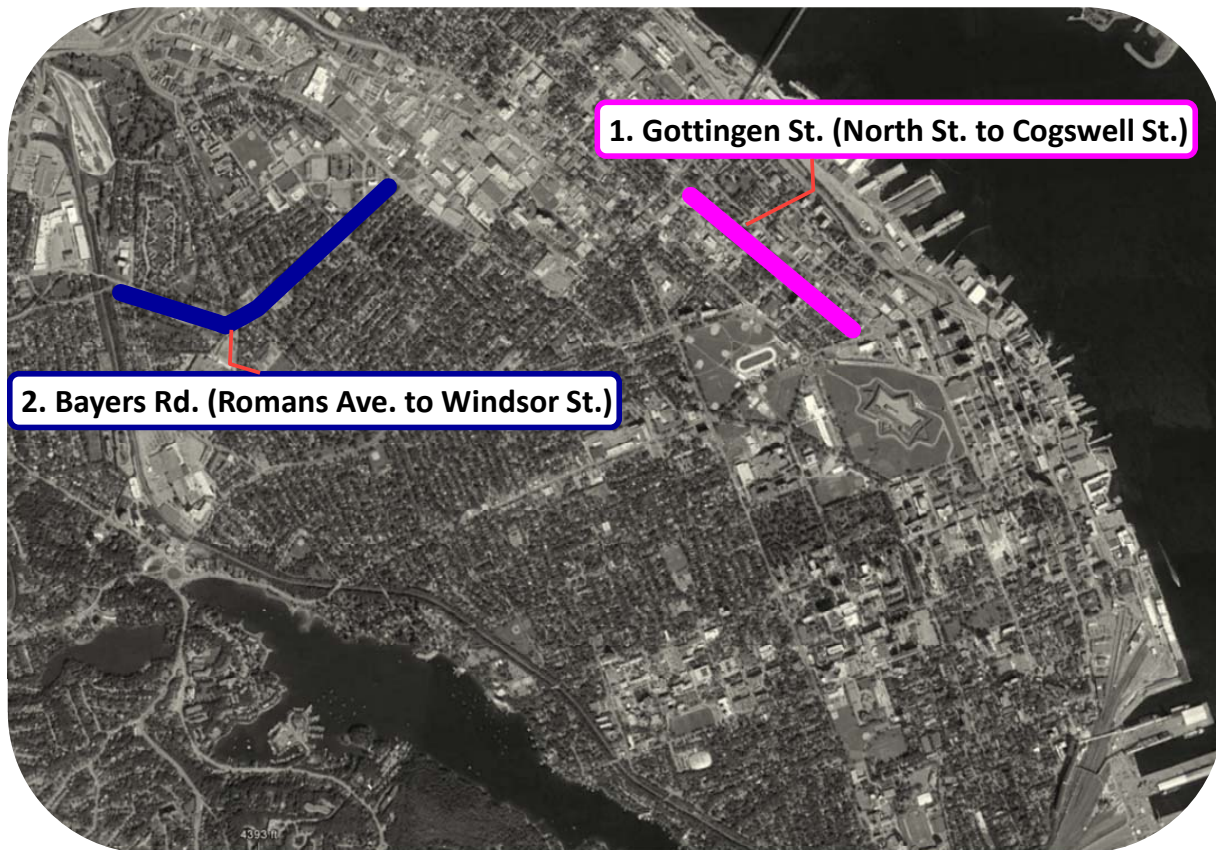

Figure 1-1 – Study Area Corridors

1.4 STUDY OBJECTIVES

The primary goal of this assignment is to develop and evaluate functional design options for transit priority along the study area corridors. Specific project objectives include:

1. Complete a detailed investigation of existing conditions within the Study Areas, including topographic survey and establishment of the functional operations of each street (i.e. traffic operation, transit delay, parking, loading, etc.);
2. Develop an understanding of existing and projected multimodal transportation demands;
3. Prepare functional design options and Class D Cost Estimates for each proposed option along each transit priority corridor;
4. Engage with key HRM internal stakeholders, external stakeholders, and the general public to identify the relevant constraints and obtain feedback on design options;
5. Complete assessments for each of the functional design options that focus on transit operational benefits, intersection performance, parking / curb access, and road safety considerations;
6. Prepare a design report that documents background information, summarizes key design assumptions and rationale, and provides comparative evaluation for each option.

2 OVERVIEW OF EXISTING OPERATIONS

2.1 TRAFFIC CONGESTION

Traffic congestion along the considered corridors has become an increasing concern in recent years. Long delays and queues have been observed throughout the study area, particularly westbound on Bayers Road during the PM peak period where travel times for traffic between Windsor Street and Connaught Avenue (a distance of approximately 800 metres) have been observed to exceed 15 minutes on a typical weekday. These long queues and high delays have led to shortcutting concerns in several adjacent residential neighbourhoods.

Moving Forward Together Plan (Halifax Transit, 2016) identifies the congestion on Bayers Road as a particular concern and recommends rerouting Transit Route #1 (Spring Garden) onto Roslyn Road, a local street, during the PM peak period “in order to maintain schedule adherence”.

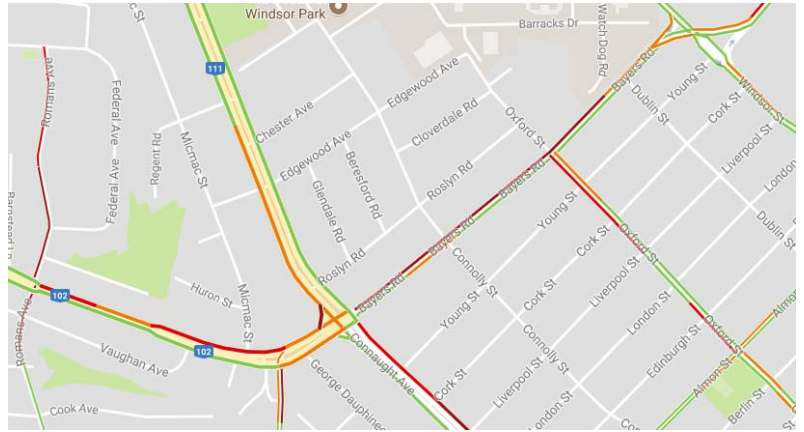

Figure 2-1 – Google Traffic Maps: 4:30 PM, Tuesday October 17, 2017

2.2 DATA COLLECTION & REVIEW

Significant data were collected at the outset of the project to develop an understanding of the existing topographic and traffic, transit, and active transportation demand along the considered corridors. The below sections summarize the methodology and results of this data collection.

2.2.1 TOPOGRAPHIC SURVEY AND GIS DATA

WSP’s survey team conducted a detailed topographic survey of the existing terrain of the corridors through the Study Area including the approach streets and abutting properties. The survey located, using real world coordinates, all relevant existing infrastructure including general site grades, curbs, power / communications systems, trees, and any other features that may affect the proposed designs. The data were imported into AutoCAD drawings for use as the topographic base for the design exercise.

The topographic field survey has been supplemented with HRM supplied GIS data and aerial imagery to identify the property boundaries and HRM right-of-way limits within the study area.

2.2.2 TRAFFIC VOLUMES

Intersection turning movement counts (collected between 2014 and 2016) and existing traffic signal timings for key study area intersections were provided by HRM Traffic Management for use in the review of existing traffic characteristics and analysis of intersection performance. HRM Traffic Management also provided historical 24-hour machine counts along each corridor for consideration of historical and anticipated growth trends.

GROWTH TRENDS

Traffic volumes collected by HRM along each corridor were analyzed in order to develop an understanding of traffic growth trends. Results (See Figure 2-2) do not indicate a clear growth trend for traffic volumes on study area routes.

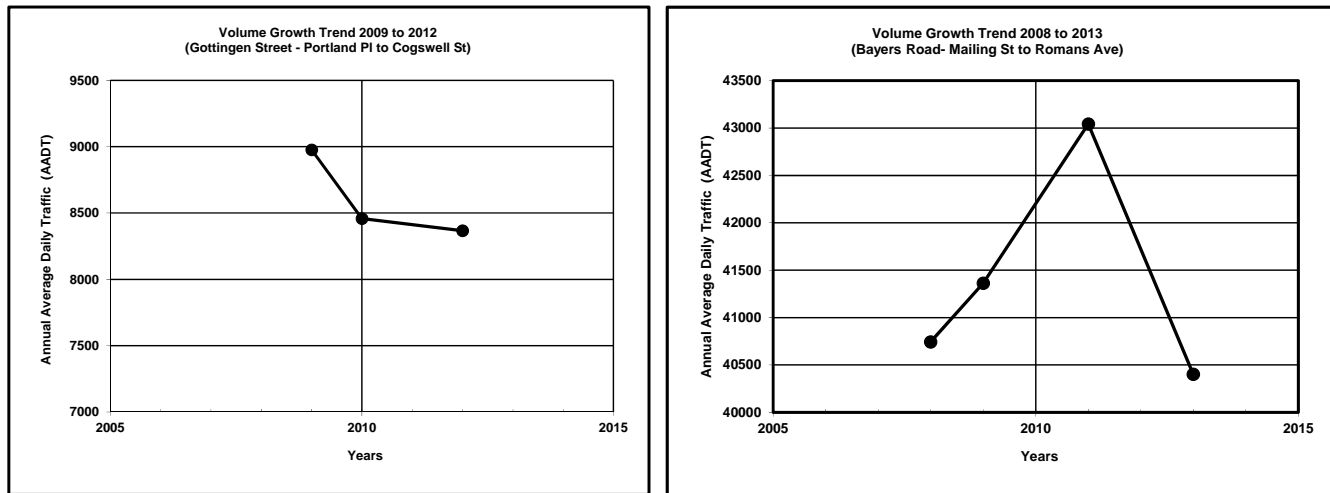

Figure 2-2 - Traffic Volume Growth Rates - Gottingen Street and Bayers Road

DESIGN HOURLY VOLUMES

Design hourly volumes were developed using the intersection turning movement count data collected by HRM Traffic Management. Based on a comparison of the count data with historical turning movement and machine count data (also provided by HRM), the intersection count data appear to be representative of typical conditions.

Given the lack of a clear historical trend of volume growth along these routes, the design hourly volumes have been estimated using the observed AM and PM peak hour volumes with no additional growth factors. Increased growth of traffic volumes would increase congestion in the analysis, increasing the need for transit priority.

2.2.3 TRANSIT DATA

Transit vehicle volumes and ridership data were provided by Halifax Transit for each existing transit route within the study area. No growth factor has been applied to the transit ridership or bus volume data. Additional transit travel time data were provided by Halifax Transit for buses along Gottingen Street.

Since there is some uncertainty of planned frequency for some of the future routes identified in *Moving Forward Together Plan* (Halifax Transit, 2016) and because ridership forecasts for these routes were not available for this project, transit vehicle and ridership volumes for existing routing were used in the analysis. It is recognized that each of the study area roads have been identified by Halifax Regional Council as Transit Priority Corridors and it expected that transit ridership and bus volumes will likely increase, particularly with the implementation of corridor level transit priority measures.

2.2.4 PEDESTRIANS AND BICYCLISTS

Available pedestrian and bicycle volume data for the study area were provided by HRM Traffic Management.

2.2.5 PARKING

Field investigation was completed by WSP to inventory the location of existing parking along each of the studied corridors. Data on parking utilization were not available.

2.2.6 ROAD SAFETY



Road safety is an important component of any design, including transit facilities. A literature review of available road safety research was completed for this project to consider the collision history along different types of transit facilities. In conducting the review, several studies were found that provided collision data for different types of transit facilities, however, no such studies were found that provided reliable data within the Canadian or American context. Most of the available research used data from Mexico, South America, India, and Australia.

Sources:

<http://www.wrirosscities.org/sites/default/files/Traffic-Safety-Bus-Priority-Corridors-BRT-EMBARQ-World-Resources-Institute.pdf>

<http://trrjournalonline.trb.org/doi/pdf/10.3141/2402-02>

There are several types of lanes in Canada that are used by transit. The most common types are summarized below:

Transit Lane Type	Description	Results of Literature Safety Review
Mixed Traffic	Transit vehicles travel in mixed use lanes and navigate congestion with other road users. This is considered the baseline scenario and represents the existing conditions on study area streets.	
Curbside Bus Lanes	The curb lane can be designated as a transit lane for the same travel direction. 	The conversion of conventional bus service to bus priority with queue jump lanes and transit signal priority was found to reduce total collisions in Melbourne, Australia by 11% while injury collisions were reduced by 25%. http://www.wrirosscities.org/sites/default/files/Traffic-Safety-Bus-Priority-Corridors-BRT-EMBARQ-World-Resources-Institute.pdf
Median Bus Lanes	 Median bus lanes provide a designated transit lane in the centre of the street. Stops are provided at specific points and left turns are only permitted at signalized intersections with protected only phases, eliminating transit conflict with turning vehicles.	The literature review identified several projects where median bus lanes offered significant safety benefits overall when compared to other transit facility types, due to reduced vehicle conflict points with vehicles. Although benefits may be realized, careful consideration of left turns and pedestrian crossings and overall road width are required.

This Space Intentionally Left Blank

3 PROJECT APPROACH / FRAMEWORK

3.1 DESIGN OBJECTIVES / CONSIDERATIONS

The design objective for this project is to provide priority for transit along each corridor while also considering active transportation, traffic operations (including heavy vehicles) as well as the impact to parking and adjacent properties. The considerations are summarized in Table 3-1.

Table 3-1 - Project Considerations

Factor	Evaluation Considerations
Halifax Transit	Efficient movement of buses through the study corridors is a key consideration of this project. Design options have reviewed the ability of buses to navigate through the intersections and along the corridors with consideration given to the estimated and observed delays under existing conditions and the potential to improve transit operation through transit priority.
Active Transportation (Pedestrians / Cyclists)	Accommodation of active transportation is very important to HRM and the provision of sidewalks and safe street crossings is an important consideration. Bayers Road in particular has been identified as a candidate for an active transportation greenway in the HRM AT plan. Evaluation of each design option based on pedestrian and cyclist accommodation will focus on the extent to which key inputs such as pedestrian / cyclist exposure to vehicular traffic (i.e. crossing distances) are expected to change with implementation of each option.
Vehicular Traffic	Both Bayers Road and Gottingen Street in the project study area are classified as arterial streets with Bayers Road serving as a key truck route to Peninsular Halifax. Ideally, vehicular capacity should remain consistent with existing conditions. The approach to assessment of impacts to vehicular traffic includes performance analysis of the intersections and the corridors under consideration. Intersection performance analysis, completed using Synchro / SimTraffic is the basis upon which intersection capacity requirements (i.e. lane configurations, # of lanes) are determined. Comparison of results among the design alternatives enables understanding of the impact that each has on vehicular traffic performance.
Parking / Loading	The available parking and loading has been identified along the study area corridors. Impacts to parking and loading have been considered in the analysis.
Right-of-Way Impacts	Consideration has been given to the impacts of roadway expansion. Where available, properties already owned by HRM were considered first and where necessary, property acquisition has been identified. Other impacts on adjacent properties (i.e. grading) were also considered in the options analysis.

3.1.1 DESIGN WORKSHOP

A Functional Design Workshop was held early in the design phase with HRM staff to discuss innovative, yet feasible options for transit priority measures along each corridor. A discussion on prioritization within a transit priority corridor began the workshop. Although it was recognized that precise priorities for each corridor and section of each corridor is highly context sensitive, the group came to a consensus that right-of-way prioritization for the transit corridors were be as follows:

- | | |
|-----------------|-----------------------------------|
| Higher Priority | 1. Sidewalk |
| ↓ | 2. Transit and transit stops |
| | 3. Non-Transit Traffic |
| | 4. Deliveries and Loading |
| | 5. Parking (Vehicular / Bicycles) |
| | Lower Priority |

Throughout the workshop, the group discussed design options for sections and key intersection along each of the corridors. The following is a summary of key highlights:

GOTTINGEN STREET

- Gottingen Street has a number of challenges including limited right-of-way and a number of uses that compete for space (e.g. on-street parking and loading, traffic, transit, cyclists, pedestrians).
- Options for traffic divergence to adjacent streets (i.e. one way on Gottingen Street) were discussed however there were concerns with having an increase of traffic on adjacent local streets.
- Removing on-street parking during peak hours were discussed and should be considered in the functional design options.
- Options for how to make Gottingen Street a transit priority corridor must be well thought out. It is highly used by pedestrians with currently limited sidewalk space, it has an active business community and is a dense residential community directly on and adjacent to the corridor. Existing built forms have little to no setbacks off of Gottingen Street which makes road widening not feasible.

BAYERS ROAD: ROMANS AVENUE TO CONNAUGHT AVENUE

- Agreement that two curbside transit lanes (one in each direction) should be considered. This option however, would require widening of the right-of-way.

BAYERS ROAD: HALIFAX SHOPPING CENTRE AND CONNAUGHT AVENUE INTERSECTIONS

- This section was identified as a significant challenge along the corridor. The two intersections are closely spaced together and result in traffic queues from all approaching directions during peak times.
- HRM owns property to the north (between the two intersections) which could be incorporated to alleviate traffic congestion in this area.
- Design options ranging in level of investment were discussed and included building an overpass across the HRM owned property (high investment), to realigning lanes and signals timing (low investment).

BAYERS ROAD: CONNAUGHT AVENUE TO WINDSOR STREET

- Two full-time transit lanes along this segment should be considered that would require a high level of investment.
- Currently, there are high transit volumes traveling on this segment of the corridor, so a high investment option may be worth implementing.
- Having bi-directional bus-only lanes may require road widening and elimination of a west-bound traffic lane.
- Other options requiring lower levels of investment (and lower impacts to adjacent residential properties) will need to be considered.

BAYERS ROAD: BAYERS ROAD/ YOUNG STREET/ & WINDSOR STREET INTERSECTION

- Options for a roundabout were discussed, however it is difficult to incorporate a bus-only lane with this design option.
- Other options must be considered that would involve bus-only transit lanes to travel through the intersection efficiently.

3.2 STAKEHOLDER & COMMUNITY CONSULTATION

One of the key aspects of this project was the consultation with stakeholders and the public at large. Separate meetings were held with HRM staff, stakeholder groups external to the municipality, and with the public through Open House style meetings.

3.2.1 HRM INTERNAL STAKEHOLDERS

A meeting was held with HRM Internal staff who provided insight in various areas of expertise related to TPM on the identified corridors. Attendees represented the following areas of interest and expertise:

- Strategic Transportation Planning
- Traffic Management
- Parking Management
- Halifax Transit
- Streetscaping and Active Transportation
- Planning and Development
- Urban Forestry
- Cogswell Redevelopment Project

The following is a summary of what we heard from HRM staff:

GOTTINGEN STREET

- Currently, the congestion of buses during PM peak periods spills over on to Cogswell Street. Need to consider how to improve this situation.
- The Macdonald Bridge bikeway overpass will change the intersection alignment at Gottingen Street and North Street.
- Existing off-street paid parking on the corridor will be used for development (making it unavailable for public parking in the future). A parking analysis will need to be done prior to any decisions being made.
- Parking for local businesses will be of concern. Want to try to make sure we don't have a net loss of parking in the area. If spaces on Gottingen Street are removed, where will they be replaced? Adjacent side streets?
- If higher order bus stops are being planned, consider the setbacks needed for them. The right of way is pretty tight as it is.

BAYERS ROAD

- There is currently a plan to implement a 3 metre multi-purpose trail for Active Transportation between Vaughan Ave. and George Dauphinee Ave.
- Currently, streetscaping along the west end of Bayers Road is not conducive to pedestrian use. Vaughan Ave. is a more pleasant walk for pedestrians as it is (quieter, safer, and less stressful).
- The forthcoming Centre Plan has policy outlining the importance of developing on corridors and identifies that greater front yard setbacks on new developments will be required. These setbacks will reflect the likely need for the Municipality to acquire land in the future.
- Staff identified there is an opportunity for **alignment of Transit Priority Measures with the Centre Plan.**
- Must consider the impact of trees, (individual stands as well as on the mix of species in an area) along the corridor. There are large elms on Bayers Road before Connaught Ave.
 - Also need to consider how to build projects in the city and still achieve the goals set in the Urban Forest Master Plan. If trees need to be removed, can more be planted elsewhere (i.e. on other parts of the right-of-way or on private property)?
- On-street parking may be an issue on the east end of the corridor.
- A particularly challenging issue will be between the Halifax Shopping Centre and Connaught Ave. Should look at traffic numbers coming to and from the Halifax Shopping Centre.

3.2.2 EXTERNAL STAKEHOLDER ENGAGEMENT

Separate meetings with stakeholders external to municipal staff were also held. Project information and consultation meetings were held with the Halifax Utility Coordinating Committee (HUCC), the North End Business Association (NEBA), and various community advocacy groups. The following is a summary of feedback provided from each of the external stakeholder meetings.

HALIFAX UTILITY COORDINATING COMMITTEE (HUCC)

- Prior to any construction, HUCC members will need to know whether or not utility relocation is required.
- A change in curbs will be their biggest concern. These will have impacts of where their services are located.
- Currently the right-of-way on Gottingen Street is very tight. Relocation will be costly.
- Bayers Road: Bell Aliant has a major cross-section of cable routes along this corridor. If this cross section had to be moved, it would be very costly and time consuming.
- Will federal infrastructure money help pay for the costs to relocate utilities?

NORTH END BUSINESS ASSOCIATION (NEBA)

- Highly concerned about having Gottingen Street designated as a TPM corridor.
- Having on-street parking and loading available for businesses is essential for commercial viability.
- Currently, the buses on Gottingen Street are loud and noisy. If more buses travel on Gottingen Street, NEBA felt this will worsen these negative impacts and degrade the street's public realm.
- During non-peak periods, members of NEBA indicated that few passengers are actually on the buses that travel down Gottingen Street. NEBA members asked how Halifax Transit can make their routing more efficient/more effective for moving people without having under-utilized buses travel the corridor?
- The Link and express buses turn Gottingen Street into a “bus highway”. NEBA indicated that the community doesn't want buses traveling through the corridor if they're not actually serving the immediate community.
- NEBA felt that buses (especially Link or express routes), should be using Barrington Street to move north. NEBA asked Halifax Transit to work with the Bridge Commission to fix the geometry of the ramp to the Macdonald Bridge so that buses can be accommodated and re-routed from Gottingen Street.
- NEBA felt that putting more buses on the corridor will negatively impact businesses on Gottingen St. Members indicated that it has taken years to bring life and vibrancy back onto the street.
- Attention should be given to the crosswalk at Gottingen Street & Buddy Daye Street. This is frequently used (by children) and doesn't have great visibility to drivers.

COMMUNITY ADVOCACY GROUPS

Members from community advocacy groups came together for a project introduction and consultation meeting. The following groups were represented at this meeting:

- Walk n Roll
- Halifax Cycling Coalition
- DalTrac
- It's More than Buses
- Canadian National Institute for the Blind (CNIB)

The following is a summary of what was heard:

GOTTINGEN STREET

- Similar concerns were voiced from community group representatives that had been heard from the NEBA meeting: noise and pollution impacts, should avoid turning Gottingen into a “bus highway”, concerns about the impacts of removing on-street parking for local businesses.
- Consider using TPM treatments on Gottingen Street to “brand” transit priority. I.e. consider colouring the pavement for the bus only lanes.
- The bike ramp off of the Macdonald Bridge will impact how cyclists use Gottingen Street. Coming off the bridge, using Gottingen Street seems to be a natural transition. However currently, the IMP has Brunswick as the dedicated cycling route. Does this make sense?
- The topic of making Gottingen Street a bus/pedestrian/cyclist only corridor (e.g. no cars permitted) was discussed. This option could have the potential of improving the public realm by implementing bicycle infrastructure, widening sidewalks, as well as giving transit the space it needs to move through effectively.
- Similar to Bayers Road, HRM needs to consider accessibility planning. For the visually impaired, it is much easier to delineate the sidewalk and roadway when there is landscaping/grass between the curb and the walking area. Audible bus stops are also recommended to accommodate the visually impaired.
- How will TPM impact cyclists? Need to make sure these measures are not to their detriment.

BAYERS ROAD

- Community Group representatives felt that there is a difference between this proposal for road widening, and the one that happened 8-10 years ago on Bayers Road. If road widening is happening to bring more buses on the road (and not cars), there will likely be less resistance and more acceptance to the project.
- Community Group representatives suggested HRM should consider congestion pricing – tax personal motor vehicles going into the peninsula. This will be easier (and less money) than doing road widening.
- Representatives indicated that this is an opportunity to turn Bayers Road into a true Complete Street. It is currently in desperate need for a pedestrian and cycling realm improvement. Bayers Road could be the “poster child” for Halifax’s complete streets.
- HRM needs to consider accessibility planning: consider sidewalk access, audible bus stops, grades, etc.

3.2.3 PUBLIC OPEN HOUSE

Two open houses, (one focused on Bayers Road, and the other focused on Gottingen Street), were held for members of the public to review the proposed functional design options along each of the two corridors. Using panel displays, residents were shown design options for segments of the corridor ranging from high investment (giving transit greatest priority), medium investment, and low investment (giving transit minimal priority). With each design option, a summary of user impacts were provided as well as an overview of pros and cons should the design be implemented. Residents were asked to provide their feedback and indicate which of the design options they prefer (if any at all). Copies of the public open house boards for both Gottingen Street and Bayers Road are included in Appendix A while comment feedback for each are presented in Appendix B.



Photo 1 - Gottingen Street Open House - October 2, 2017

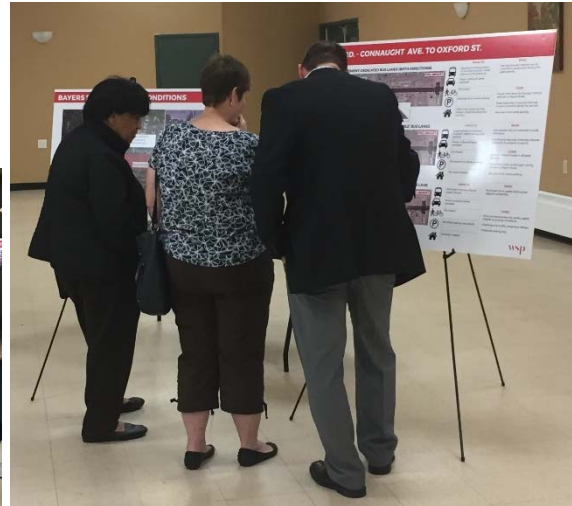

Photo 2 - Bayers Road Open House - September 28, 2017

3.2.4 ONLINE CONSULTATION

An online survey was commissioned by the HRM project team to gather further public input on the display boards (Appendix A) and made available on the project's Shape Your City website. Paper copies of the survey were also made available at each of the two Open Houses. Results of the survey have been generated by HRM staff and have been presented in Appendix C.

The following are key highlights from the online survey for each of the two corridors:

GOTTINGEN STREET, n = 296

- Forty percent of survey participants travelled the corridor in a personal motor vehicle. Sixty percent travelled through on transit, bicycle, or as a pedestrian.
- Pedestrian safety and comfort was the most important issue that mattered to survey participants with over half indicating their current experience with pedestrian safety and comfort were good or excellent.
- Loss of on-street parking was the most acceptable trade-off with the addition of a transit-only lane. Motor vehicle congestion or delay was the least acceptable.
- For all corridor sections, the High Investment option was identified as the most favourable among survey participants.

BAYERS ROAD, n = 488

- Over half of respondents usually travelled through the corridor in a personal motor vehicle (as a driver or as a passenger).
- Transit reliability was the most important issue that mattered to survey participants and over half indicated their current experience with transit schedules were considered poor.
- Loss of on-street parking was the most acceptable trade-off with the addition of a transit-only lane while increase of motor vehicle congestion or delay was the least acceptable.
- For all corridor segments, the High Investment option was the most favourable among survey participants.

3.3 ANALYSIS FRAMEWORK

The analysis of each option includes consideration of impacts on Transit Operations, Multimodal Level of Service, Traffic, Parking/Loading, and Property Impacts. The analysis framework for each of these considerations is described in the subsequent sections.

3.3.1 VEHICULAR IMPACTS (TRANSIT AND NON-TRANSIT)

In *Halifax Transit Priority Measures Study* (WSP, 2016) an analysis framework was developed to consider the costs and benefits to transit and the overall public of a given transit priority measure. That methodology has since been included as Appendix E in *Moving Forward Together Plan* (Halifax Transit, 2016) as the methodology used for the evaluation of transit priority measures. This methodology follows the following five steps:

1. **Develop estimates for the Capital Cost** using preliminary cost estimates based on functional designs.
2. **Develop estimates for annual operating cost** using approximate costs for similar measures.
3. **Develop operational cost savings to Halifax Transit** using estimates in delay reductions to transit vehicles. This can be obtained from field observation or traffic modeling and a combination of both have been used for this project.
4. **Understand the TPM's Impact to All Road Users** using estimates in changes in delay to the movement of people using the particular intersection or corridor. This includes changes in delay to transit users as well as any estimated change in delay to motorists, cyclists, or pedestrians.
5. **Determine the payback period for the Measure** using the results of the previous four steps.



To estimate the impact on transit flow that could be expected with each option along each corridor, the delay reductions to the average transit vehicle have been estimated using traffic analysis (Synchro 9 and SimTraffic) and supplemented with field observation and transit data provided by Halifax Transit. This analysis has been carried into the cost analysis and overall evaluation. The methodology to calculate the delay and payback period are included in Appendix E.

3.3.2 MULTIMODAL LEVEL OF SERVICE (MMLOS)

Multimodal level of service (MMLOS) is an evaluation framework that takes a more holistic approach to intersection performance analysis than the typical vehicle-focused models that are commonplace. The framework for MMLOS is based on *NCHRP Report 616* (National Cooperative Highway Research Program NCHRP, Washington, 2008), a publication that summarizes the results of a 2-year investigation of how users perceive the multimodal quality of service on urban streets. LOS models were calibrated that rate the level of comfort and delay felt by pedestrian, bicycle, and transit users at an intersection and along a corridor and enable the analysis of “tradeoffs” of various allocations of the urban street cross section among auto, pedestrian, bicycle, and transit users. The intent is to provide a more complete representation of how key variables impact the accommodation of different road users.

The NCHRP framework for MMLOS has been applied to evaluate design alternatives for the study area. The following summarizes the NCHRP framework and how it was applied to this project:

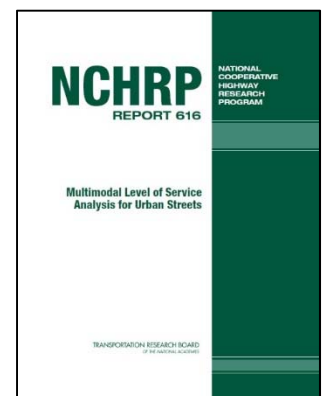

- NCHRP 616 included MMLOS models for corridors and signalized intersections only.
- Although there are transit multimodal level of service models for corridors, the factors for transit LOS consider transit scheduling and transit amenities (benches, shelters) that are outside the scope of this project. Evaluation of transit performance along each corridor has been performed separately.
- *Highway Capacity Manual 2010* (HCM 2010, National Academy of Sciences, Washington, 2010) used the research and models included in NCHRP 616 to provide MMLOS models for intersections and segments in HCM 2010. New to HCM 2010 was the MMLOS criteria for pedestrians at Two-way STOP controlled intersections (TWSC); however, HCM 2010 does not provide bicycle MMLOS at TWSC. Table 3-2 summarizes the factors that were found to influence the level of service of pedestrians and bicyclists.

Table 3-2 - Factors that influence Intersection Multimodal LOS by Active Mode (HCM 2010)

		Pedestrian LOS	Bicyclist LOS
Signalized Intersection MMLOS	Negative Influence	<ul style="list-style-type: none"> • Volume of right turns on red • Volume of permitted left turns • Traffic in outside lane • Traffic speed • Number of lanes • Pedestrian delay • Right-turn channelized lanes (low traffic volume locations) 	<ul style="list-style-type: none"> • Width of cross street • Volume of traffic
	Positive Influence	<ul style="list-style-type: none"> • Right-turn channelized lanes (high traffic volume locations) 	<ul style="list-style-type: none"> • Width of outside through lane (and bicycle lane) • Number of lanes on approach direction
Two-Way STOP-Controlled Intersection MMLOS	Negative Influence	<ul style="list-style-type: none"> • Vehicle volume • Crosswalk length • Number of lanes 	No model provided
	Positive Influence	<ul style="list-style-type: none"> • Crosswalk width • Driver yield rates 	
Overall Segment	Negative Influence	<ul style="list-style-type: none"> • Traffic volume per lane • Vehicle travel speed • Poor intersection MMLOS 	<ul style="list-style-type: none"> • Signalized Intersections • Traffic volume per lane • Vehicle travel speed • Heavy vehicle volume • Poor intersection MMLOS
	Positive Influence	<ul style="list-style-type: none"> • Width of outside through lane (and bicycle lane) • Parking occupancy • Presence of sidewalk buffer • Sidewalk width 	<ul style="list-style-type: none"> • Width of outside through lane (and bicycle lane)

3.3.3 PARKING / LOADING

WSP has conducted field review to quantify the available parking / loading along each corridor and consider the impact to parking and loading with each option.

3.3.4 ROAD SAFETY

WSP has reviewed available collision records and how the options could be expected to impact road safety through changes to the number of conflict points and expected travel speeds.

3.3.5 COST ESTIMATES

With each option developed for these corridors, Class D cost estimates have been prepared to estimate the construction cost. These estimates are considered high level estimates and do not include property acquisition or HST. Cost Estimates for each option are included in Appendix D.

3.3.6 OVERALL ANALYSIS

Using consideration of the above factors and results from the public and stakeholder consultation, overall evaluation matrices were developed for each corridor in order to display the overall assessment of each option and enable comparison between categories (identified in Table 3-3). For simplicity, the matrices has been formatted to a colour scale from green (most favorable) to red (least favorable), with yellow the intermediate shade. Grey was used to indicate criteria that were not applicable or where information was not available. It should be recognized that since this evaluation scheme does not apply weighting factors to the various evaluation criteria, it essentially assigns equal value to each criteria. This is obviously not the case in reality, as transit schedule adherence may be a more influential factor on these identified transit corridors than traffic impacts. As presented, the evaluation matrix is a visual tool that enables high level options comparison.

Each option for the full corridor has also been evaluated using the payback period analysis methodology included in *Moving Forward Together Plan* (Halifax Transit, 2016) with the methodology shown in Appendix E.

Table 3-3 - Considered Categories for Analysis

	Transit Travel Time
	Transit Schedule Reliability
	Transit Visibility
User Experience	Walking
	Bicycling
	MMLOS
	Road Safety
Impacts	Traffic Impacts
	Property Requirements
	Green space / Urban Forest
	Implementation Cost
Public Support	Public Feedback Response

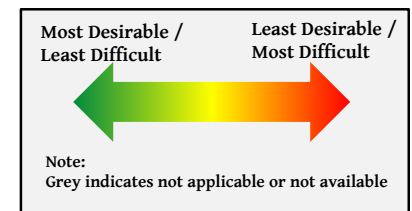

This Space Intentionally Left Blank

4 GOTTINGEN STREET

4.1 EXISTING CONDITIONS

Gottingen Street between Cogswell Street and North Street (approximately 1.1 km) is a two-lane arterial roadway. Traffic data obtained by HRM Traffic Management indicate a weekday two-way traffic volume of approximately 8,400 vehicles per day (vpd).

Along the corridor, the intersections of North Street, Cornwallis Street, and Cogswell Street are signalized. The remaining seven intersections (with Charles Street, Uniacke Street, Buddy Daye Street, Cunard Street, Falkland Street, and Portland Place) are all T-intersections with STOP control on the side street and free flow on Gottingen Street.

With approximately 10 metres of asphalt width on Gottingen Street south of Buddy Daye Street and intermittent parking available on both sides, the flow of transit and traffic vehicles are already impacted by the narrowed through lanes (See Figure 4-1).

Although much of this corridor is theoretically free flow, congestion has been observed throughout the day, particularly during the PM peak period when northbound traffic queues toward North Street extend along the corridor (See Figure 4-2).



Photo 3 - Queued outbound bus - 4:45 PM

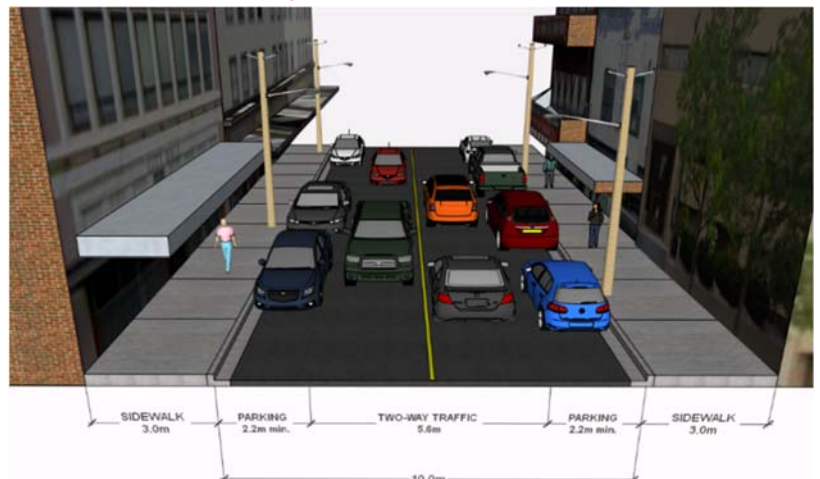

Figure 4-1 - Gottingen Street Typical Cross Section Looking South
Buddy Daye Street to Falkland Street



Figure 4-2 - Google Traffic Map - 5:00 PM, Wednesday, July 19, 2017

4.1.1 EXISTING TRANSIT

Gottingen Street is a very busy transit corridor for Halifax Transit, particularly during the PM peak period. It is currently used by 18 Halifax Transit Routes (#1, 7, 10, 11, 21, 31, 33, 34, 41, 53, 59, 61, 68, 86, 159, 320, 330, and 370). Transit vehicle volume and ridership data were collected by Halifax Transit and are summarized in Table 4-1.

Table 4-1 - Existing Transit Volumes and Ridership along Existing Routes

		Transit Vehicles	Transit Riders
AM Peak Hour	Southbound	15	770
	Northbound	25	200
PM Peak Hour	Southbound	4	50
	Northbound	56	1600

4.1.2 EXISTING TRAFFIC

Turning movement counts at the Gottingen Street intersections with North Street, Cornwallis Street, and Cogswell Street were collected by HRM Traffic Management for the morning (7-9 AM) and afternoon (4-6 PM) peak periods. The AM and PM design hour volumes are summarized in Figure 4-3. Traffic analysis of existing conditions was prepared using *Synchro 9* and is summarized in Appendix F.

Additional pedestrian volume data were provided by HRM Traffic Management for the existing crosswalks at Charles Street, Uniacke Street, Buddy Daye Street, and Cunard Street. No pedestrian volume data were available for the marked crosswalk at Falkland Street.

4.1.3 EXISTING MULTIMODAL ANALYSIS

Using available traffic, pedestrian, and bicycle count data from HRM Traffic Management and the geometric configuration of the existing sidewalk and lane layouts, the pedestrian and bicycle multi-modal level of service for the key intersections and corridor segments were determined.

Analysis finds that the segment MMLOS for pedestrians is 'C' or 'D' and for bicyclists is 'D' in each of the AM and PM peak hours.

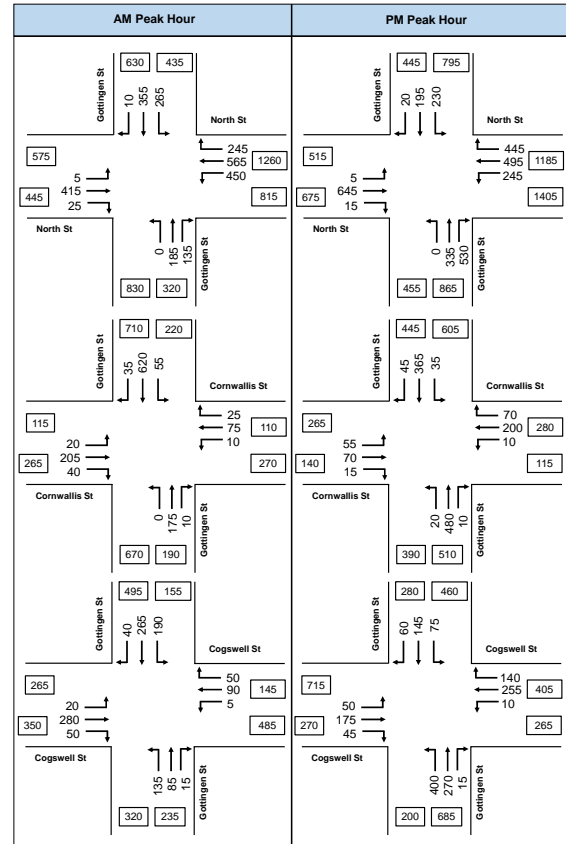

Figure 4-3 - Gottingen St Corridor AM and PM design hour traffic volumes

4.1.4 ROAD SAFETY

Available data for collisions occurring within the Gottingen Street study area in 2015 and 2016 were provided by the Halifax Regional Police and reviewed to consider if any mitigative measures could be identified. The available collision reports indicate that of the 31 reported study area collisions with available information, approximately 40% (12) involved a parked vehicle. No other trends were identified.

4.1.5 EXISTING PARKING



During the day, parking is permitted on Gottingen Street as shown in Figure 4-4. Additional no stopping restrictions are in place on the east (northbound) side between 4-6 PM.



Figure 4-4 - Existing Parking on Gottingen Street

4.2 GOTTINGEN STREET MODIFICATION OPTIONS

Three modification options were prepared for the Gottingen Street study area and are summarized below. Functional design plans for each option are included in Appendix A and cost estimates are included in Appendix D.

Option	Description
<p>High Investment</p> <p>Option G1 – Continuous NB Transit Lane</p>  <p>*Proposed cross section looking south</p>	<ul style="list-style-type: none"> Remove parking/loading from Gottingen Street; Provide a continuous northbound right turn lane (except buses); and, Install Pedestrian Half-Signals at Key Pedestrian Crossings. <p><u>Impacts:</u></p> <ul style="list-style-type: none"> Provides a continuous transit lane in the critical northbound direction. Removal of parking and separation of northbound buses is expected to improve flow of traffic along the corridor. Positive for safety due to noted collision trend and less need to cross centre line to get around parked vehicles. Analysis (Appendix F) indicates minimal impact to non-transit vehicles while providing significant transit benefit.
<p>Medium Investment</p> <p>Option G2 – NB Transit Priority at Key Intersections</p>  <p>*Proposed cross section looking south at key intersections only</p>	<ul style="list-style-type: none"> Remove parking/loading from Gottingen Street during peak periods; Provide transit queue jump lanes at key locations; and, Install Pedestrian Half-Signals at Key Pedestrian Crossings <p><u>Impacts:</u></p> <ul style="list-style-type: none"> Provides transit priority measures at key locations while having minimal impact on parking/loading during offpeak periods. Improved flow of traffic along the corridor is expected during peak periods. Positive for safety due to noted collision trend and less need to cross centre line to get around parked vehicles. Analysis at the Cornwallis Street intersection (Appendix F) indicates minimal impact to non-transit vehicles while providing transit benefit.
<p>Low Investment</p> <p>Option G3 – Remove Peak Period Parking</p>  <p>*Proposed cross section looking south</p>	<p><u>Impacts:</u></p> <ul style="list-style-type: none"> Does not specifically provide transit priority. Minor improvements to flow of traffic (and transit) along the corridor considering current restriction already in place during PM peak for northbound. Positive for safety due to noted collision trend and less need to cross centre line to get around parked vehicles.

4.3 GOTTINGEN STREET OPTIONS EVALUATION

Using the available data, traffic flow models were created using SimTraffic to develop estimates for changes in user delay with each option. Table 4-2 summarizes the benefits to transit and non-transit users and the estimated implementation costs (See Appendix D).

An options evaluation matrix was created in order to display the overall assessment of each option and enable comparison between categories (See Table 4-3). As presented, the evaluation matrix is a visual tool that enables high level options comparison.

Table 4-2 - Gottingen Street - Overall Corridor Options Summary

Corridor Segment	G1 - Continuous NB Transit Lane	G2 - Transit Priority at Key Intersections	G3 - Remove Parking
Total Estimated Annual Operating Cost Savings to Halifax Transit	\$36,625	\$8,610	\$3,340
Total Estimated Daily Reduction in Transit User Delay	65 hrs	15 hrs	5 hrs
Total Estimated Daily Reduction in Overall User Delay	70 hrs	20 hrs	10 hrs
Total Estimated Implementation Cost	\$0.25 Million	\$0.22 Million	Negligible Cost (Signage Only)

Table 4-3 Gottingen Street Options Evaluation Summary Matrix

		Transit Corridor Options			
		Existing Conditions	G1. Continuous NB Lane	G2. NB Transit Priority - Key Locations	G3. Parking / Loading Modifications
User Experience	Transit Travel Time	Orange	Green	Yellow	Orange
	Transit Schedule Reliability	Red	Green	Green	Orange
	Transit Visibility	Red	Green	Green	Red
	Walking	Green	Green	Green	Green
	Bicycling	Yellow	Orange	Yellow	Green
	MMLOS	Yellow	Orange	Yellow	Yellow
	Road Safety	Yellow	Green	Green	Green
Impacts	Traffic Impacts	Grey	Green	Green	Green
	Loading/Parking Impacts	Grey	Red	Orange	Orange
	Implementation Cost	Grey	Green	Green	Green
Public Support	Public Feedback Response	Grey	Green	Green	Yellow

Most Desirable / Least Difficult Least Desirable / Most Difficult

Note: Grey indicates not applicable or not available

Note: There is no anticipated impact to the right of way width or available space for green space / urban forest.

Each option for the full corridor was evaluated using the payback period analysis methodology included in *Moving Forward Together Plan* (Halifax Transit, 2016) and summarized in Section 3.3.1. The methodology is included in Appendix E with results summarized in Table 4-4.

Table 4-4 - Overall Payback Period Analysis – Gottingen Street

		Gottingen Street		
		G1- Continous Northbound Transit Lane	G2- NB Transit Priority at Key Intersections	G3- Remove Peak Period Parking; No Specific Transit Priority
Estimated Daily Delay Savings to Transit Users		~65 pass.hr	-15 pass.hr	~5 pass.hr
Estimated Daily Delay Savings to All Road Users		~70 pass.hr 5	~20 pass.hr 4	~10 pass.hr 3
Payback Period		0.6 years 5	2.0 years 4	N/A 5
Other Key Factors	Score for Other Factors ¹	3	1	0
	Safety Considerations	(+)Improved flow through network and reduced parking manoeuvres		
	Impact to Other Users	(-)Loss of Parking Half signal for pedestrians may improve pedestrian safety but increase pedestrian delay		(-)Loss of Parking
	Project Integration	None identified		
	TPM Enforcement Requirements	Enforcement of typical signage required		None
	Issues to Implementation	None		
	Promotion of Transit	(+)Good Promotion of Transit	Some Promotion of Transit	None
Schedule Adherence	(++)Greatly improved schedule adherence	(+)Improved schedule adherence	(+)Some improvements may be realized	
Public Consultation	(++)Generally viewed as the best option overall	(+)Viewed as a good option	Generally seen as the least desirable option overall	
Stakeholder Consultation	(--)Concern for parking/loading	(-)Loss of SB parking during peak periods		
Overall Evaluation		13	9	8
NOTES: 1. Score for other factors is the sum of the positive impacts less the negative impacts. Impacts with "++" or "--" received double score.				

Comparative evaluation of the user impacts (Table 4-3) and payback analysis (Table 4-4) indicates that greater overall benefit is expected with Option G1 (Continuous northbound transit lane) and this option should be considered for implementation by HRM.

This Space Intentionally Left Blank

5 BAYERS ROAD

5.1 EXISTING CONDITIONS

Bayers Road between Romans Avenue and Windsor Street (approximately 1.4 km) is an arterial roadway. In this area the roadway transitions from a four lane cross section near Romans Avenue (See Figure 5-2) to seven lanes around the Halifax Shopping Centre (HSC) and reduces to a three lane section plus parking east of Connaught Avenue (See Figure 5-1). Traffic data obtained by HRM Traffic Management indicate a weekday two-way traffic volume of between 15,000 and 45,000 vehicles per day (vpd).

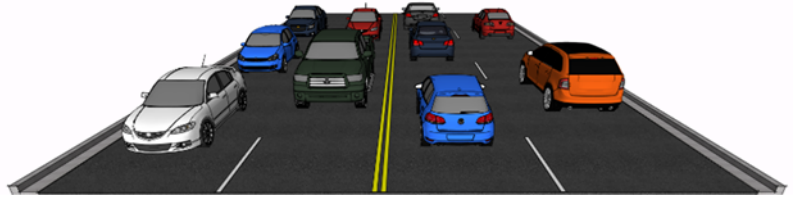

Figure 5-2 - Typical Cross Section Looking East-Bayers Road near Romans Avenue

Significant congestion has been observed along this corridor, particularly during the peak periods when inbound traffic in the morning has been observed to back up onto Highway 102 while outbound traffic congestion during the afternoon peak has been observed to extend through the entire corridor. Travel times in the outbound direction between Oxford Street and Connaught Avenue during the PM peak period have been observed to exceed 15 minutes, indicating severe congestion in this area and contributes to shortcutting onto local streets (shown in Figure 5-3).

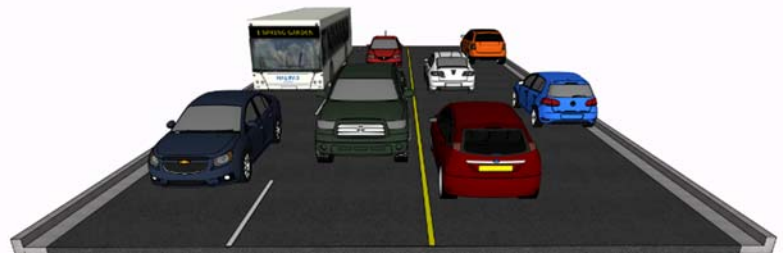

Figure 5-1 - Typical Cross Section Looking East-Connaught Avenue to Windsor Street

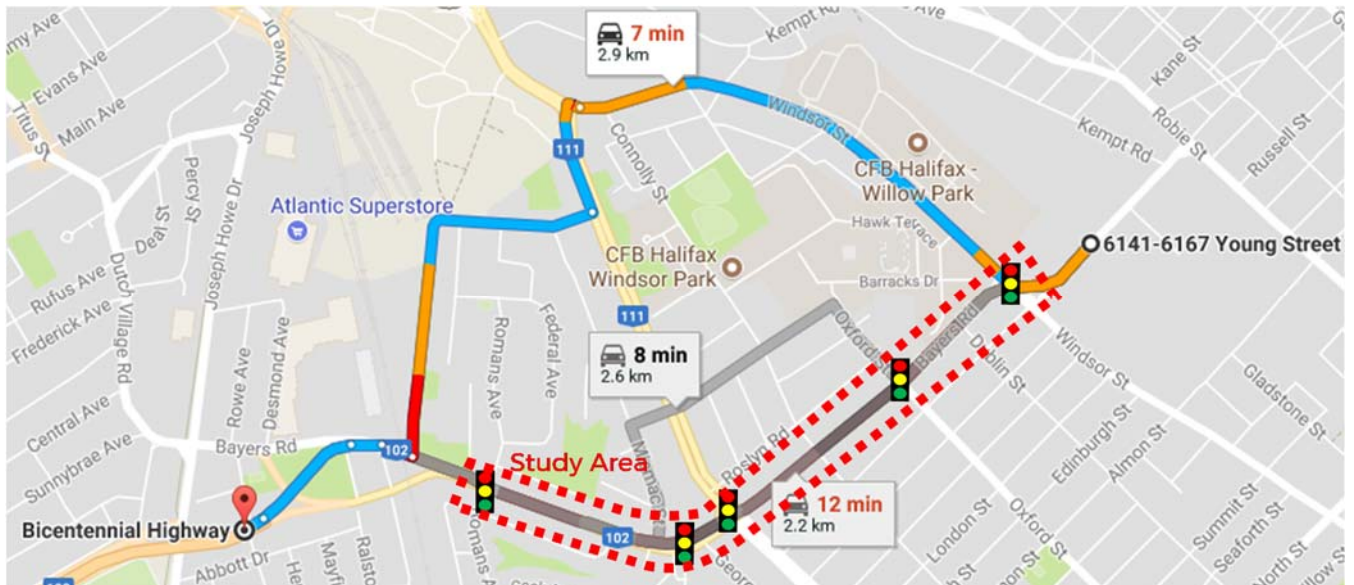

Figure 5-3 - Google Traffic Map - 4:30 PM, Tuesday, October 17, 2017
(Travel time through the uncongested corridor is approximately 4 minutes)

5.1.1 EXISTING TRANSIT

Bayers Road is currently used by 7 Halifax Transit Routes (#1, 2, 9, 17, 80, 81, and 330, See Figure 5-4). Transit ridership data were collected by Halifax Transit and indicate that at the Connaught Avenue intersection there are estimated to be:

- 37 two-way buses carrying 700 transit riders in the AM peak hour; and,
- 35 two-way two way buses carrying 730 transit riders in the PM peak hour.

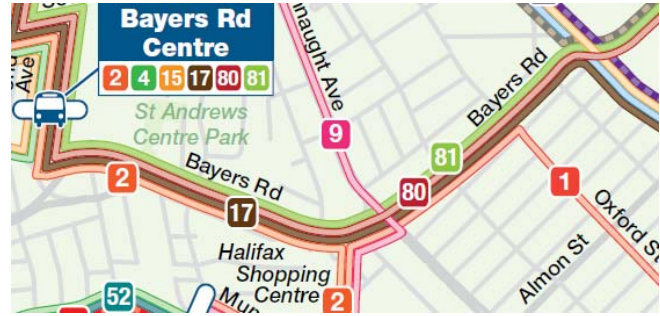

Figure 5-4 - Halifax Transit Routes on Bayers Road

5.1.2 EXISTING TRAFFIC

Turning movement counts at the Bayers Road intersections with Romans Avenue, Halifax Shopping Centre (HSC), Connaught Avenue, Oxford Street, and Windsor Street were collected by HRM Traffic Management for the morning (7-9 AM) and afternoon (4-6 PM) peak periods. AM and PM Design Hourly Volumes for the Romans, HSC, Connaught, and Windsor intersections are summarized in Figure 5-5. Traffic analysis of existing conditions was prepared using *Synchro 9* and is summarized in Appendix G.

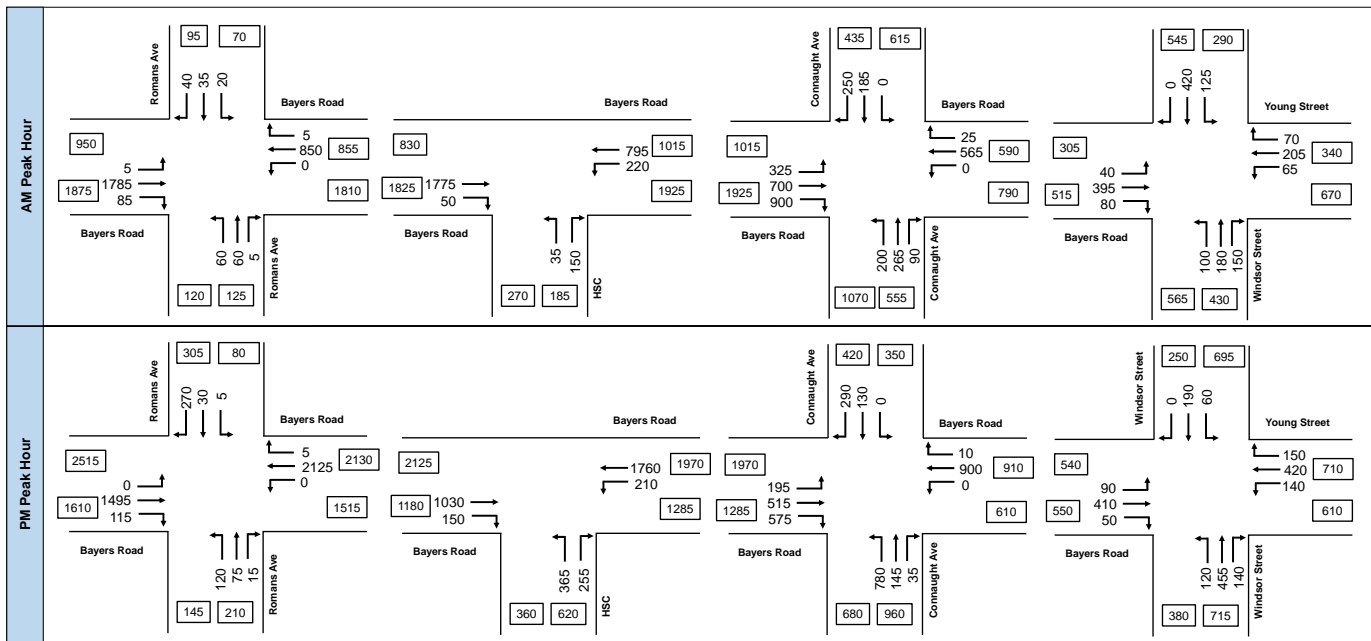

Figure 5-5 - Bayers Road Corridor AM and PM Design Hourly Traffic Volumes

5.1.3 EXISTING MULTIMODAL ANALYSIS

Using available traffic, pedestrian, and bicycle count data from HRM Traffic Management and the geometric configuration of the existing and proposed sidewalk and lane layouts, the pedestrian and bicycle multi-modal level of service for the corridor segments were estimated (See Section 3.3.2).

	Romans Avenue to Connaught Avenue	Connaught Avenue to Windsor Street
Existing Bicycle MMLOS	With high traffic volumes and no designated bicycle facilities the existing segment bicycle MMLOS is overall 'E' in both directions during the AM and PM peak hours.	With lower traffic volumes but still no designated bicycle facilities the existing segment bicycle MMLOS is overall 'D' or 'E' during the AM and PM peak hours.
Existing Pedestrian MMLOS	With high traffic volumes and sidewalk near the roadway, segment pedestrian MMLOS is overall 'D' or 'E' for both sides during the AM and PM peak hours.	With lower traffic volumes and sidewalk near the roadway, segment pedestrian MMLOS is overall 'D' for both sides during the AM and PM peak hours.

5.1.4 ROAD SAFETY

Collision reports were not available for this corridor for collision analysis. A comparative analysis between the options for this corridor considered how each option changed the number or type of conflict points.

5.1.5 EXISTING PARKING

Parking is generally restricted along this corridor with the following exceptions:

- The south side between Connolly Street and east of Dublin Street is time restricted with some unrestricted parking; and,
- The north side between Oxford Street and west of Connolly Street is signed as no stopping during the PM peak period and is otherwise unrestricted.

5.2 BAYERS ROAD MODIFICATION OPTIONS

With the changing road width and varying traffic volumes along Bayers Road, this corridor has been separated into four segments for the development and evaluation of transit priority options. The four road segments are identified in Figure 5-6.

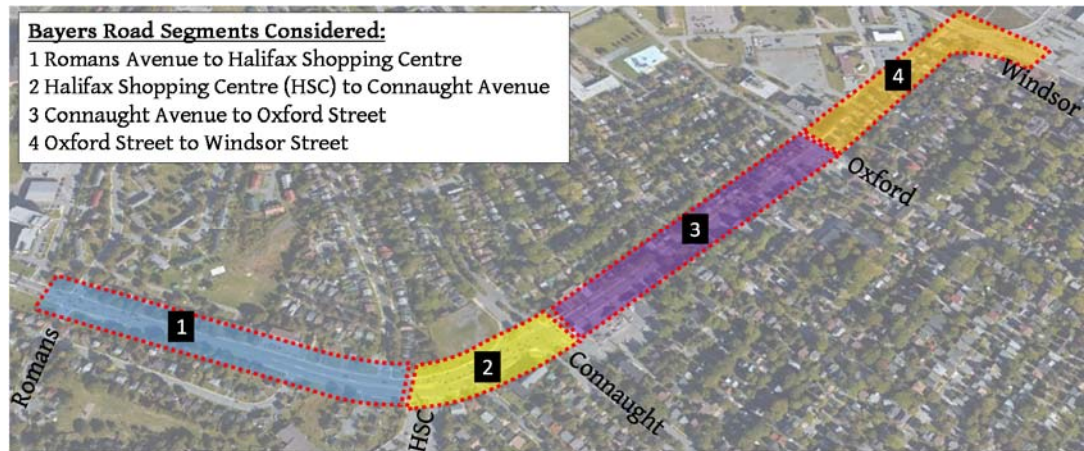

Figure 5-6 - Bayers Road Segments Considered in this Study

Recognizing the congestion, the high traffic volumes, the importance of this

corridor as a truck and traffic route to and from Peninsular Halifax, and the priorities for allocation of street space, options have been prepared for each of the segments of this corridor. These options for each segment are shown conceptually in Appendix A and described in subsequent sections of this report.

Lane Requirements:

At the outset of the project, traffic analysis was prepared to assess the lane requirements for each segment of the corridor. Analysis considered whether reductions to one through lane in each direction for non-transit could accommodate the traffic volumes without causing significant negative impact to non-transit vehicle operations.

Intersection analysis results (See Appendix G) indicate that the operations of the intersections in segments #1 and #2 (Figure 5-6) approach or exceed capacity with two through lanes for non-transit with existing volumes and lane configurations. Analysis indicates that while traffic in segments #3 and #4 could be accommodated by a single through lane in each direction, reduction to a single lane in each direction is expected to significantly impact capacity for non-transit vehicles in segments #1 and #2. Since no eastbound transit lane is proposed west of the study area, this increased congestion of non-transit vehicles is expected to impact eastbound transit movements as they approach the study area.

Traffic analysis results indicate that:

- **Two non-transit lanes** in each direction should be provided along segments #1 and #2; and,
- **One non-transit lane** in each direction along segments #3 and #4 is expected to accommodate the non-transit volumes.



Proposed AT Greenway Cost Estimates:

Although cost estimates include the installation of the proposed AT greenway between Romans and George Dauphinee, the installation of the greenway is not considered integral to the provision of transit priority along this corridor and has not been included in the cost-benefit analysis of the transit options.

It is estimated that the total installation cost (excluding property acquisition and HST) of the proposed AT greenway between Romans Avenue and George Dauphinee Avenue is approximately \$335,000 and is not contingent on which roadway option is selected.

5.2.1 ROMANS AVENUE TO HALIFAX SHOPPING CENTRE

This segment of Bayers Road has two through lanes in each direction and experiences very heavy through volumes during the AM and PM peak periods. Two modification options (plans included in Appendix A) were prepared for this segment and are summarized below. Intersection analysis is included in Appendix G.

Option		Description
High Investment	1 – Widen to Install Continuous EB and WB Transit Lanes 	<ul style="list-style-type: none"> Widen on south side to provide a continuous eastbound and westbound transit lanes; and, Install offstreet active transportation greenway. <p><u>Impacts:</u></p> <ul style="list-style-type: none"> Requires some property acquisition on south side of Bayers Road. Provides a full-time continuous transit lane in both directions. Removes transit vehicles and right turns from flow of non-transit vehicles Provides offstreet active transportation greenway
Medium Investment	2 – Widen to Install Reversible Lane and designate transit lane in peak direction 	<ul style="list-style-type: none"> Widen on southside to provide a continuous eastbound transit lane in the AM peak period and westbound transit lane in the PM peak period; Install reversible lane signage (similar to Chebucto Road, Macdonald Bridge); and, Install offstreet active transportation greenway. <p><u>Impacts:</u></p> <ul style="list-style-type: none"> Requires some property acquisition on south side of Bayers Road. Provides a full-time continuous transit lane in peak direction. Removes transit vehicles and right turns from flow of non-transit vehicles in peak direction. Provides offstreet active transportation greenway. Negative safety impact with reversible lane and complicated time of day transit lane signage.

An options evaluation matrix was created in order to display the overall assessment of each option and enable comparison between categories (See Table 5-1).

Table 5-1 – Bayers Road – Romans Avenue to Coleman Court Options Evaluation Summary Matrix

		Transit Corridor Options		
		Existing Conditions	1. Continuous Transit Lanes	Opt 2. Reversible Lane
User Experience	Transit Travel Time	Red	Green	Green
	Transit Schedule Reliability	Red	Green	Orange
	Transit Visibility	Red	Green	Yellow
	Walking	Orange	Yellow	Yellow
	Bicycling	Red	Green	Green
	MMLoS	Orange	Green	Green
	Road Safety	Yellow	Green	Red
Impacts	Traffic Impacts	Grey	Green	Yellow
	Property Requirements	Grey	Orange	Orange
	Green space / Urban Forest	Grey	Orange	Yellow
	Implementation Cost	Grey	Orange	Orange
Public Support	Public Feedback Response	Grey	Green	Yellow



Most Desirable / Least Difficult ← → Least Desirable / Most Difficult

Note: Grey indicates not applicable or not available

Note: Parking is already restricted and there is no proposed change to parking.

5.2.2 HALIFAX SHOPPING CENTRE (HSC) TO CONNAUGHT AVENUE

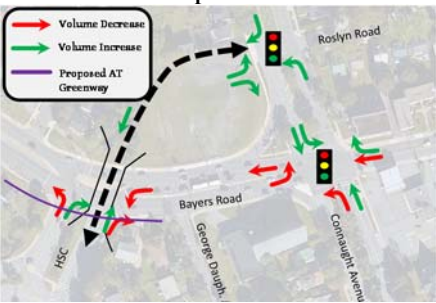
With approximately 100 metres between the Connaught and HSC (east) intersection, queuing and lane changes by turning traffic are frequently observed. Modification options (plans included in Appendix A) were prepared for this segment and are summarized below. Intersection analysis is included in Appendix G.

Option	Description
<p style="writing-mode: vertical-rl; transform: rotate(180deg);">High Investment</p>	<p>1 – Construct Overpass To HSC</p>  <ul style="list-style-type: none"> Reprofile Bayers Road and Connaught Avenue to install grade separation over Bayers Road for connection to HSC; Remove traffic signals from HSC intersections; Install traffic signals at Connaught Avenue / Roslyn Road intersection; Modify HSC (west) driveway to become right-in, right-out only; and, Install offstreet active transportation greenway. <p><u>Impacts:</u></p> <ul style="list-style-type: none"> Requires property acquisition. Impacts access to HSC. Impacts grades on Bayers Road and access to adjacent properties. Expected to significantly improve traffic flow. Reduced merging manoeuvres are expected to provide significant safety improvement. Removes signalized crossing for AT greenway through this segment. Expected to create significant disruption during construction.
<p style="writing-mode: vertical-rl; transform: rotate(180deg);">Medium Investment</p>	<p>2A – Construct new roadway to HSC</p>  <ul style="list-style-type: none"> Construct a driveway connecting Connaught Avenue opposite Roslyn Road to Halifax Shopping Centre; Restrict left turns from Bayers Road to Halifax Shopping Centre; and, Install offstreet active transportation greenway. <p><u>Impacts:</u></p> <ul style="list-style-type: none"> Requires property acquisition. Impacts access to HSC. Expected to improve traffic flow. Reduced merging manoeuvres expected to provide safety improvement. Analysis (Appendix G) indicates benefit to transit and non-transit. <p>2B – Construct new transit-only roadway to HSC</p> <p>(Option developed following Public Consultation)</p> <ul style="list-style-type: none"> Similar to Option 2A, a roadway could be constructed that would allow transit vehicles to access HSC and allow right turns onto Bayers Road into a transit only lane. This would allow outbound transit vehicles to bypass congestion in this segment without changing access to HSC. <p><u>Impacts:</u></p> <ul style="list-style-type: none"> Requires property acquisition. No safety benefit of reduced merging / diverging of turning traffic to HSC. Requires installation of a receiving lane for transit vehicles on private property. May complicate operations on HSC property.
<p style="writing-mode: vertical-rl; transform: rotate(180deg);">Low Investment</p>	<p>3 – Widen to provide transit lanes</p> <ul style="list-style-type: none"> Widen to construct transit lanes; and, Install offstreet active transportation greenway. <p><u>Impacts:</u></p> <ul style="list-style-type: none"> Requires property acquisition. Widens already wide roadway and extends pedestrian crossing distance. Little impact on traffic flow.

An options evaluation matrix was created in order to display the overall assessment of each option and enable comparison between categories (See Table 5-2).

Table 5-2 – Bayers Road – Coleman Court to Connaught Avenue Options Evaluation Summary Matrix



		Transit Corridor Options				
		Existing Conditions	Opt 1. Overpass to HSC	Opt 2A. Realigned HSC	Opt 2B. Transit only roadway	Opt 3. Widen to Install Transit Lanes
User Experience	Transit Travel Time	Red	Green	Light Green	Light Green	Yellow
	Transit Schedule Reliability	Red	Green	Light Green	Light Green	Light Green
	Transit Visibility	Red	Light Green	Light Green	Light Green	Light Green
	Walking	Orange	Light Green	Yellow	Yellow	Orange
	Bicycling	Red	Green	Light Green	Light Green	Light Green
	MMLOS	Orange	Light Green	Light Green	Light Green	Yellow
	Road Safety	Orange	Light Green	Yellow	Yellow	Orange
Impacts	Traffic Impacts	Grey	Green	Light Green	Yellow	Yellow
	Property Requirements	Grey	Red	Orange	Orange	Orange
	Green space / Urban Forest	Grey	Yellow	Yellow	Yellow	Yellow
	Implementation Cost	Grey	Red	Yellow	Yellow	Yellow
Public Support	Public Feedback Response	Grey	Green	Light Green	Grey	Yellow

Most Desirable / Least Difficult  Least Desirable / Most Difficult
 Note: Grey indicates not applicable or not available

Notes: Parking is already restricted and there is no proposed change to parking.
 Public input is not available for Option 2B.

5.2.3 CONNAUGHT AVENUE TO WINDSOR STREET

Traffic volumes collected by HRM indicate that peak period through volumes along this section are generally around 500-700 vehicles per direction. Three modification options (plans included in Appendix A) were prepared for this segment and are summarized below. Intersection analysis is included in Appendix G.

Option	Description
<p>High Investment</p> <p>1 - Install EB and WB transit lanes</p> 	<ul style="list-style-type: none"> Widen to provide a continuous eastbound and westbound transit lane; and, Remove parking. <p><u>Impacts:</u></p> <ul style="list-style-type: none"> Requires some property acquisition along the full corridor. Removes parking. Slight negative impact to westbound non-transit vehicles. Provides a full-time continuous transit lane in both directions. Removes transit vehicles and right turns from traffic flow.
<p>Medium Investment</p> <p>2 - Install reversible lane and designate transit lane in peak direction</p> 	<ul style="list-style-type: none"> Provide a continuous eastbound transit lane in the AM peak period and westbound transit lane in the PM peak period; Install reversible lane signage (similar to Chebucto Road, Macdonald Bridge); and, Remove parking. <p><u>Impacts:</u></p> <ul style="list-style-type: none"> Requires some property acquisition around Connaught Avenue and Oxford Street. Removes parking. Slight negative impact to westbound non-transit vehicles. Provides a full-time continuous transit lane in peak directions. Removes transit vehicles and right turns from traffic flow in peak direction. Negative safety impact with reversible lane and complicated time of day transit lane signage.
<p>Low Investment</p> <p>3 - Install WB transit lane</p> 	<ul style="list-style-type: none"> Provide a continuous westbound transit lane; and Remove parking in westbound direction. <p><u>Impacts:</u></p> <ul style="list-style-type: none"> Requires some property acquisition around Connaught Avenue. Removes some parking from north side. Slight negative impact to westbound non-transit vehicles. Provides some transit priority in westbound direction only.

An options evaluation matrix was created in order to display the overall assessment of each option and enable comparison between categories (See Table 5-3).

Table 5-3 – Bayers Road –Connaught Avenue to Windsor Street Options Evaluation Summary Matrix

		Transit Corridor Options			
		Existing Conditions	1. Continuous transit lanes both directions	2. Reversible lane	3. Transit Lane WB
User Experience	Transit Travel Time	Red	Green	Light Green	Yellow
	Transit Schedule Reliability	Red	Green	Light Green	Light Green
	Transit Visibility	Red	Green	Light Green	Light Green
	Walking	Yellow	Yellow	Yellow	Yellow
	Bicycling	Orange	Orange	Orange	Orange
	MMLOS	Orange	Orange	Orange	Orange
	Road Safety	Orange	Light Green	Orange	Light Green
Impacts	Traffic Impacts	Grey	Yellow	Yellow	Yellow
	Property Requirements	Grey	Orange	Yellow	Yellow
	Loading/Parking Impacts	Grey	Red	Red	Orange
	Green space / Urban Forest	Grey	Orange	Yellow	Yellow
	Implementation Cost	Grey	Yellow	Yellow	Light Green
Public Support	Public Feedback Response	Grey	Green	Light Green	Yellow

Most Desirable / Least Difficult ← → Least Desirable / Most Difficult

Note: Grey indicates not applicable or not available

5.2.4 WINDSOR STREET INTERSECTION

This intersection experiences awkward lane alignment and intersection geometry. Although roundabout configurations were considered, they were excluded due to significant property impacts and challenging signage requirements. Two modification options (plans included in Appendix A) were prepared for this intersection and are summarized below. Intersection analysis is included in Appendix G.

Option	Description
1 – Modify right turn channels and install EB and WB transit lanes	<ul style="list-style-type: none"> Modify alignment of right turn channels from Windsor Street to Bayers Road and Young Street; Designate a westbound lane as right turn only (except buses); and, Widen to install an eastbound right turn lane (except buses). <u>Impacts:</u> <ul style="list-style-type: none"> Requires some property acquisition Provides a full-time continuous transit lane in both directions. Removes transit vehicles and right turns from traffic flow.
2 – Install WB transit lane	<ul style="list-style-type: none"> Provide a continuous westbound transit lane; and, <u>Impact:</u> <ul style="list-style-type: none"> Provides transit priority in westbound direction.

An options evaluation matrix was created in order to display the overall assessment of each option and enable comparison between categories (See Table 5-4).

Table 5-4 – Bayers Road at Windsor Street Intersection Options Evaluation Summary Matrix

		Transit Corridor Options		
		Existing Conditions	1. Continuous transit lanes both directions	2. Transit Lane WB
User Experience	Transit Travel Time	Orange	Green	Yellow
	Transit Schedule Reliability	Orange	Green	Light Green
	Transit Visibility	Orange	Green	Light Green
	Walking	Orange	Light Green	Yellow
	Bicycling	Orange	Yellow	Orange
	MMLOS	Orange	Yellow	Orange
	Road Safety	Orange	Light Green	Yellow
Impacts	Traffic Impacts	Grey	Yellow	Yellow
	Property Requirements	Grey	Orange	Yellow
	Green space / Urban Forest	Grey	Light Green	Yellow
	Implementation Cost	Grey	Orange	Yellow
Public Support	Public Feedback Response	Grey	Green	Yellow



Note: Grey indicates not applicable or not available

Note: Parking at the intersection is not permitted and there is no proposed change to parking

5.3 BAYERS OPTIONS EVALUATION

In performing the overall analysis and evaluation for the full corridor it is recognized that the impacts of implementing a particular option in one segment may impact the operations in another segment. Several options (summarized in Table 5-5) were considered for the purpose of evaluating the measures along the full corridor.

Table 5-5 - Bayers Road – Overall Corridor Options Summary

		Transit Corridor Option - Bayers Road					
		B1.1 - High Investment Full Corridor	B1.2A - High Investment Med at HSC	B1.2B - High Investment Med (Transit Only) at HSC	B1.3 - High Investment Low at HSC	B2 - Medium Investment Full Corridor	B3 - Low Investment Full Corridor
Corridor Segment	Romans to HSC	Opt 1 (Continuous lanes each direction)				Opt 2: (Reversible Lane)	
	HSC to Connaught	Opt 1 (Overpass)	Opt 2A (Construct new roadway)	Opt 2B (Construct new transit roadway)	Opt 3 (Install transit lanes in both directions)	Opt 2A (Construct new roadway)	Opt 3 (Install transit lanes in both directions)
	Connaught to Windsor	Opt 1 (Continuous lanes each direction)				Opt 2 (Reversible Lane)	Opt 3 (Transit lane westbound only)
	Windsor Street Intersection	Opt 1 (Continuous lanes each direction)				Opt 2 (Modify RT channels and install EB and WB transit lanes)	
Estimated Results	Total Estimated Annual Operating Cost Savings to Halifax Transit	\$71,150	\$44,120	\$44,120	\$29,800	\$36,055	\$19,770
	Total Estimated Daily Reduction in Transit User Delay	100 hrs	60 hrs	60 hrs	40 hrs	50 hrs	25 hrs
	Total Estimated Daily Reduction in Overall User Delay	310 hrs	140 hrs	60 hrs	50 hrs	130 hrs	35 hrs
	Total Estimated Implementation Cost	\$15.9 Million	\$4.8 Million	\$4.8 Million ¹	\$3.3 Million	\$4.6 Million	\$2.1 Million
Note:	1. Cost estimates for the implementation of HSC option 2B (medium, transit only) have not specifically been prepared, however, it is expected to be similar to cost estimates to implement option 2A in that segment.						

An options evaluation matrix was created in order to display the overall assessment of each option and enable comparison between categories (See Table 5-6). Each option for the full corridor was evaluated using the payback period analysis methodology (See Appendix E) included in Moving Forward Together Plan (Halifax Transit, 2016) and as described in Section 3.3.1 with results summarized in Table 5-7.

Table 5-6 - Bayers Road – Overall Corridor Options Evaluation Summary Matrix

		Existing Conditions	Transit Corridor Options					B2. Medium Investment	B3. Low Investment
			B1.1 High Investment	B1.2A High with Med at HSC	B1.2B High with Med (Transit Only) at HSC	B1.3 High with Low at HSC			
User Experience	Transit Travel Time	Red	Green	Yellow	Yellow	Yellow	Yellow	Yellow	
	Transit Schedule Reliability	Red	Green	Yellow	Yellow	Yellow	Yellow	Yellow	
	Transit Viability	Red	Green	Yellow	Yellow	Yellow	Yellow	Yellow	
	Walking	Orange	Green	Yellow	Yellow	Yellow	Yellow	Yellow	
	Bicycling	Red	Green	Yellow	Yellow	Yellow	Yellow	Yellow	
	MMLLOS	Orange	Green	Yellow	Yellow	Yellow	Yellow	Yellow	
Impacts	Road Safety	Orange	Green	Yellow	Yellow	Yellow	Yellow	Yellow	
	Traffic Impacts	Grey	Green	Yellow	Yellow	Yellow	Yellow	Yellow	
	Property Requirements	Grey	Orange	Yellow	Yellow	Yellow	Yellow	Yellow	
	Green space / Urban Forest	Grey	Orange	Yellow	Yellow	Yellow	Yellow	Yellow	
	Loading/Parking Impacts	Grey	Orange	Yellow	Yellow	Yellow	Yellow	Yellow	
Public Support	Implementation Cost	Red	Orange	Yellow	Yellow	Yellow	Yellow	Yellow	
	Public Feedback Response	Grey	Green	Yellow	Yellow	Yellow	Yellow	Yellow	

Note: Grey indicates not applicable or not available

Comparative evaluation of the user impacts (Table 5-6) and payback analysis (Table 5-7) indicate that although significant delay savings are anticipated with Option B1.1 (High Investment), after consideration of cost, property impacts, and urban form, the best overall option is expected to be Option B1.2A (High Investment, Medium through HSC segment) which offers a strong mix for all users and this option should be considered for implementation by HRM.

Table 5-7 – Bayers Road Corridor Options - Payback Period Analysis

		Bayers Road					
		B1.1-High Investment Full Corridor	B1.2A-High Investment Medium at HSC	B1.2B-High Investment Medium (Transit Only) at HSC ²	B1.3-High Investment Low at HSC	B2- Medium Investment	B3-Low Investment
Estimated Daily Delay Savings to Transit Users		~100 pass.hr	~60 pass.hr	~60 pass.hr	~40 pass.hr	~50 pass hr	~25 pass.hr
Estimated Daily Delay Savings to All Road Users		~310 pass.hr 5	~140 pass.hr 4	~70 pass.hr 3	~50 pass.hr 3	~130 pass hr 4	~35 pass.hr 3
Payback Period to Public		9.0 years 4	6.1 years 5	13.3 years 3	14.4 years 3	6.2 years 5	10.0 years 4
Score for Other Factors ¹		5	5	6	4	1	1
Safety Considerations		(-)Grade separation removes merging and crossing conflicts	Reduced congestion may provide improvement	Reduced congestion may provide improvement	Separation of buses from through movement may provide some improvement	(-)Reversible lane may not be understood by all drivers Reduced congestion may provide improvement	Separation of buses from through movement may provide some improvement
Impact to Other Users		(+)Provides grade separated crossings for AT users (+)Significant improvements for emergency vehicles	(+)Improvements for emergency vehicles	(+)Improvements for emergency vehicles	(+)Some improvements for emergency vehicles	(+)Improvements for emergency vehicles	(+)Some improvements for emergency vehicles
Project Integration		Opportunity to integrate with new AT greenway between Romans and George Dauphinee					
TPM Enforcement Requirements		No Specific Requirements Identified					
Issues to Implementation		(-)Property acquisition required along full corridor (-)Impacts to access for HSC and other properties (-)Grading challenges through HSC segment	(-)Property acquisition required along full corridor (-)Impacts to access for HSC	(-)Property acquisition required along full corridor	(-)Property acquisition required along full corridor	(-)Property acquisition required along full corridor (-)Impacts to access for HSC	(-)Property acquisition required along a portion of the corridor
Promotion of Transit		(++)Excellent promotion of transit	(++)Excellent promotion of transit	(++)Excellent promotion of transit	(++)Excellent promotion of transit	(+)Good Promotion of Transit	Some Promotion of Transit
Schedule Adherence		(++)Greatly improved Schedule adherence in both directions	(++)Greatly improved Schedule adherence in both directions	(++)Greatly improved Schedule adherence in both directions	(+)Improved Schedule adherence in both directions	(+)Improved Schedule adherence, mostly in peak directions	(+)Some improved Schedule adherence at key intersections
Public Consultation		(++)Generally seen as the best option by the public	(++)Seen as a good option by the public overall	(++)Seen as a good option by the public overall	(+)Considered a good option	(+)Seen as a good option by the public	Generally perceived to be the least desirable option
Overall Evaluation		14	14	12	10	10	8

NOTES: 1. Score for other factors is the sum of the positive impacts less the negative impacts. Impacts with "+" or "++" receive double score.
2. Implementation cost for this option is expected to be similar for Option B1.2A

6 SUMMARY & RECOMMENDATIONS

6.1 SUMMARY

Recent and ongoing policy development efforts have made improvements to Halifax’s transit service a key priority for the Municipality. Specifically, Halifax Transit’s *Moving Forward Together Plan* (adopted by Regional Council in April 2016) includes bold moves that will aim to improve transit service levels through increased priority, enhanced reliability, and reduced travel time. The bold moves are being made in support of the following four Council-endorsed ‘*Moving Forward Principles*’:

1. Increase the proportion of resources allocated towards high ridership services.
2. Build a simplified transfer based system.
3. Invest in service quality and reliability.
4. Give transit increased priority in the transportation network.

Among the key initiatives that the Municipality is considering for transit upgrades are Transit Priority Measures (TPMs) – strategically located street and intersection upgrades that provide priority for the movement of buses. Building on HRM’s recent success of implementing TPMs at various locations, the Municipality is interested in investigating corridor-level transit priority upgrades that satisfy specific recommendations of the *Moving Forward Together Plan* including two “critical locations” that were identified for transit priority measures: **Bayers Road** and **Gottingen Street**.

To address this identified need for transit priority along these two corridors, options were developed and evaluated against the level of impact that they are expected to have on transit operation as well as on active transportation (AT), general traffic, parking, road safety, and implementation cost.

Following initial development of the options for each corridor, consultation was held to gather input from key stakeholders and community groups through several stakeholder meetings as well as from the overall public through one public open house for each corridor and through online consultation through the project’s Shape Your City website.

Options preparation included a significant data collection phase that included topographic survey, as well as obtaining and reviewing data on transit vehicle and ridership volumes, volumes of traffic, pedestrians, and bicycle, as well as the review of available collision records and consideration of public and stakeholder input. Analysis was completed to evaluate the identified options using criteria developed through discussion with HRM staff as well as the methodology presented in Appendix E of *Moving Forward Together* (Halifax Transit, 2016).

6.2 RECOMMENDATIONS

Based on the background review, public and stakeholder consultation, functional design, various analysis frameworks, and comparative analysis, the recommendations have been developed for consideration by HRM.

Consideration was given to the phasing of corridor improvements. A proposed implementation plan has been identified with recommendations presented as Priority A, B, or C where items in Priority 'A' should generally be considered during the earlier years of the Action Plan, with those in Priority 'C' considered in the later years.

6.2.1 RECOMMENDATIONS - GOTTINGEN STREET

1. HRM should complete a parking analysis to determine the level of parking utilization for the Gottingen Street spaces and potential areas on adjacent streets that can accommodate additional parking.
2. HRM should install Option G3 along the entire corridor between Cogswell Street and North Street. This involves the removal of parking during the AM and PM peak periods and is considered the low investment option. Although this option does not specifically provide transit priority along this corridor it is expected to offer benefit to traffic progression along this corridor and provide overall road safety benefit addressing noted existing collision trend with parked vehicles.
3. HRM should install the transit priority measure at the Cornwallis Street to provide a queue jump for northbound buses.
4. HRM should consider a trial period where some parking additional parking is removed around the Cornwallis intersection to gather information on the effectiveness of providing a longer transit queue jump.
5. In the future the transit lane could be extended along the length of the corridor and consideration given to pedestrian half-signals at key pedestrian crossings.

PRIORITY 'A'

- Complete a parking analysis of utilization of parking on adjacent streets to develop a strategy to offset loss of parking along the Gottingen Street corridor.
- Implement Option G-3 (Remove parking / loading during peak periods).
- Design and install northbound transit priority measure at Cornwallis Street intersection.
- Consider some additional parking restrictions surrounding the Cornwallis Street intersection to extend the transit lane to improve operations.
- Design pedestrian half signal at Uniacke Street intersection.

PRIORITY 'B'

- Install pedestrian half signal at Uniacke Street intersection.
- Design pedestrian half signal at Cunard Street intersection.

PRIORITY 'C'

- Install pedestrian half signal at Cunard Street intersection.
- Implement continuous northbound transit lane for the full corridor on a trial basis.

6.2.2 RECOMMENDATIONS – BAYERS ROAD

Segment 1 - Romans Avenue to Halifax Shopping Centre (HSC):

1. HRM should plan for the installation of one transit only lane in each direction. In addition to providing benefit to transit during the peak direction it is expected to offer safety benefits when compared to a reversing lane and use of time of day transit lane signage.

Segment 2 - Halifax Shopping Centre (HSC) to Connaught Avenue:

2. Although the high investment option at the HSC segment is expected to create significant benefit to transit and non-transit vehicles, there are expected to be significant issues to implementation that may make this option infeasible. In addition to cost, Option 1 (overpass) is expected to have significant impacts to property with significant retaining walls and grading challenges. Option 2A through this segment provides the best overall balance of the project objectives as it is expected to provide significant transit priority while considering the urban form through this area. HRM should seek to implement the medium investment option (Option 2A) through the HSC segment.

Segment 3 - Connaught Avenue to Windsor Street:

3. Connaught Avenue is considered a key intersection along this corridor and two westbound lanes for non-transit vehicles should be provided approaching Connaught Avenue for a distance of approximately 100 metres.
4. HRM should plan for the implementation of the high investment option (one continuous transit lane in each direction) through this segment.
5. Depending on construction timelines, a phased approach could be implemented where:
 - a. Road widening between Connaught Avenue and Connolly Street could provide the transit priority lanes and maintain the two westbound through lanes. This could be accompanied by signage and marking modifications east of Connolly to provide a westbound transit lane while maintaining existing road width.
 - b. Widening east of Connolly Street should be completed in a subsequent construction phase.

Segment 4 - Windsor Street Intersection:

6. In addition to providing transit priority in both directions, the high investment option is expected to offer benefits by modifying the right turn channels from Windsor Street to provide improved lane geometry and alignment at the intersection and provide improved lane balance with recommended improvements in Segment 3. HRM should plan for the implementation of this option.

PRIORITY 'A'

- Initiate acquisition of identified properties to implement Option B-1.2 (Medium investment through HSC segment, High investment otherwise).
- Design and implement modifications for continuous transit lanes in both directions for Romans Avenue to HSC.
- Design and implement modifications for Option 2A (Medium investment) through the HSC segment. This should include road widening that extends 100 metres east of Connaught Avenue to provide transit priority and two westbound approach lanes at that intersection.
- Consider modifications to provide a westbound transit lane (Option 3) between Windsor Street and Connolly Street.
- Design modifications at the Windsor Street intersection.

PRIORITY 'B'

- Implement modifications at the Windsor Street intersection.
- Design modifications to install a transit lane in each direction between Connaught Avenue and Windsor Street.

PRIORITY 'C'

- Implement modifications to provide a continuous transit lane in each direction between Connolly Street and Windsor Street.

APPENDIX

A FUNCTIONAL DESIGNS

A large, white, diagonal shape that resembles a stylized letter 'V' or a folded corner, positioned on the left side of the page, partially overlapping the text 'DESIGNS'.

Functional Designs
Are Included in the HRM Staff Report

APPENDIX

B

PUBLIC

CONSULTATION

FEEDBACK

FORMS

Public Consultation Feedback Forms
Are Included in the HRM Staff Report

APPENDIX

C ONLINE CONSULTATION RESULTS

Online Consultation Results
Are Included in the HRM Staff Report

APPENDIX

D

COST

ESTIMATES

HRM TRANSIT PRIORITY CORRIDORS - GOTTINGEN STREET

HIGH LEVEL ESTIMATE OF PROBABLE COSTS



PROJECT NO. 171-09619
 DATE: Jan. 15, 2018
 CLIENT: HRM
 CONSULTANT: WSP
 UNIT PRICE SOURCE: WSP

Disclaimer: This estimate of probable construction cost is approximate only. Actual cost may vary significantly from this estimate due to market conditions such as material and labour costs, time of year, industry workload, competition, etc. This estimate has been prepared based on our experience with similar projects. This estimate has not been prepared by obtaining any estimates or quotes from contractors. Due to the uncertainties of what contractors bid, WSP cannot make any assurances that this estimate will be within a reasonable range of the tendered low bid. When assessing this project for business feasibility purposes this estimate should not be relied upon without considering these factors.

NOTE:

1. HST NOT INCLUDED IN INDICATED UNIT PRICES AND TOTALS.
2. ESTIMATE BASED ON FUNCTIONAL DESIGN DRAWINGS PROVIDED FOR PUBLIC OPEN HOUSE ON OCT. 2, 2017.
3. ALL PRICES SHOWN ARE IN 2017 CANADIAN DOLLARS.
4. ESTIMATE DOES NOT INCLUDE ALLOWANCES FOR ENGINEERING, ADMINISTRATION OR INSPECTION FEES.
5. COSTS AND QUANTITIES ASSUME NO OTHER WORK IS BEING DONE IN CONJUNCTION WITH TRANSIT PRIORITY IMPROVEMENT MEASURES.
6. OPTION G3 (LOW INVESTMENT SCENARIO) IS NOT SHOWN SINCE THE ONLY COST IS FOR REPLACEMENT OF STOPPING / PARKING RESTRICTION SIGNS WHICH IS EXCLUDED FROM THESE ESTIMATES.

ITEM	DESCRIPTION	UNITS	UNIT PRICE	Option G1*		Option G2*	
				QNTY.	COST	QNTY.	COST
STREET CONSTRUCTION							
46	Signs (Incl. reinstatement)	each	\$1,500	4	\$6,000	2	\$3,000
ADDITIONAL ITEMS							
65.1	Pavement Markings	LS	Varies	1	\$14,100	1	\$10,800
65.2	Removal of Existing Pavement Markings	LS	Varies	1	\$6,000	1	\$6,000
65.3	Red In-Lay Reserved Lane Symbol	each	\$5,000	6	\$30,000	3	\$15,000
ELECTRICAL							
85	Installation of Half Signals	LS	\$75,000	2	\$150,000	2	\$150,000
MISCELLANEOUS							
93	Traffic Control	LS	Varies	1	\$25,000	1	\$25,000

Sub-Total	\$231,100	\$209,800
Contingency (30%)	\$69,330	\$62,940
ESTIMATED COST (excl. HST)	\$300,000	\$273,000

***OPTIONS**

G1	Continuous Northbound Transit Lane
G2	NB Transit Priority at Key Intersections

**HRM TRANSIT PRIORITY CORRIDORS
HIGH LEVEL ESTIMATE OF PROBABLE COSTS**



PROJECT NO. 171-09619
 DATE: Jan. 15, 2018
 CLIENT: HRM
 CONSULTANT: WSP
 UNIT PRICE SOURCE: WSP
 NOTES:

Disclaimer: This estimate of probable construction cost is approximate only. Actual cost may vary significantly from this estimate due to market conditions such as material and labour costs, time of year, industry workload, competition, etc. This estimate has been prepared based on our experience with similar projects. This estimate has not been prepared by obtaining any estimates or quotes from contractors. Due to the uncertainties of what contractors bid, WSP cannot make any assurances that this estimate will be within a reasonable range of the tendered low bid. When assessing this project for business feasibility purposes this estimate should not be relied upon without considering these factors.

- HST NOT INCLUDED IN INDICATED UNIT PRICES AND TOTALS.
- ESTIMATE BASED ON FUNCTIONAL DESIGN DRAWINGS PROVIDED FOR PUBLIC OPEN HOUSE ON SEPT. 28, 2017.
- ALL PRICES SHOWN ARE IN 2017 CANADIAN DOLLARS.
- ESTIMATE DOES NOT INCLUDE COST ALLOWANCES FOR PROPERTY ACQUISITION, UTILITY POLE RELOCATION, ENGINEERING, ADMINISTRATION OR INSPECTION
- COSTS AND QUANTITIES ASSUME ONLY A.T. TRAIL INSTALLATION AND NO ADDITIONAL WORK IS BEING DONE IN CONJUNCTION WITH TRANSIT PRIORITY IMPROVEMENT
- STREET CONSTRUCTION UNIT PRICE INCLUDES PLACEMENT OF TYPE I AND TYPE II GRAVELS, AND TYPE B-HF AND TYPE C-HF ASPHALT.
- OPTION B2 ASSUMES PLANNING AND OVERLAY OF 50mm TYPE C-HF ASPHALT FOR HALIFAX SHOPPING CENTER INTERSECTION AREA.

ITEM	DESCRIPTION	UNITS	UNIT PRICE	Option B1.1		Option B1.2		Option B1.3		Option B2		Option B3	
				QNTY.	COST	QNTY.	COST	QNTY.	COST	QNTY.	COST	QNTY.	COST
EARTHWORKS													
3	Mass Excavation & Embankment	m3	\$25	5,000	\$125,000	2,500	\$62,500	0	\$0	2,500	\$62,500	500	\$12,500
4	Excavation - Rock	m3	\$100	5,000	\$500,000	0	\$0	0	\$0	0	\$0	0	\$0
5	Unsuitable Material	m3	\$40	1,000	\$40,000	0	\$0	0	\$0	0	\$0	0	\$0
6	Replacement of Unsuitables	m3	\$55	1,000	\$55,000	0	\$0	0	\$0	0	\$0	0	\$0
7	Borrow	m3	\$25	10,000	\$250,000	0	\$0	0	\$0	0	\$0	0	\$0
9.2	Fine Grading of Road Surface	m2	\$2	14,000	\$28,000	10,530	\$21,060	4,300	\$8,600	9,150	\$18,300	1,800	\$3,600
WATER SYSTEM													
10	Pipe (Removal and Replacement)	m	\$750	400	\$300,000	0	\$0	0	\$0	0	\$0	0	\$0
11	Hydrant (Removal and Replacement)	each	\$7,500	2	\$15,000	0	\$0	0	\$0	0	\$0	0	\$0
13	Valve (Removal and Replacement)	each	\$5,000	10	\$50,000	0	\$0	0	\$0	0	\$0	0	\$0
14.3.1	Service Fittings (Removal and Replacement)	each	\$2,500	7	\$17,500	0	\$0	0	\$0	0	\$0	0	\$0
14.3.2	Service Pipe (Removal and Replacement)	m	\$250	70	\$17,500	0	\$0	0	\$0	0	\$0	0	\$0
15	Connection to Existing Main	each	\$6,000	6	\$36,000	0	\$0	0	\$0	0	\$0	0	\$0
17	Temporary Water Service	LS	\$50,000	1	\$50,000	0	\$0	0	\$0	0	\$0	0	\$0
SANITARY SYSTEM (COMBINED)													
20	Gravity Pipe (Removal and Replacement)	m	\$750	400	\$300,000	0	\$0	0	\$0	0	\$0	0	\$0
22	Manholes (Removal and Replacement)	each	\$8,500	22	\$187,000	0	\$0	0	\$0	0	\$0	0	\$0
23	Services (Removal and Replacement)	m	\$650	150	\$97,500	0	\$0	0	\$0	0	\$0	0	\$0
24	Connection to Existing Main	each	\$2,500	15	\$37,500	0	\$0	0	\$0	0	\$0	0	\$0
STORM SEWER													
32.1	Catchbasin Relocation / Installation	each	\$6,500	56	\$364,000	41	\$266,500	31	\$201,500	30	\$195,000	15	\$97,500
33.2	Catchbasin Leads (Removal and Replacement)	m	\$600	392	\$235,200	287	\$172,200	217	\$130,200	210	\$126,000	105	\$63,000
STREET CONSTRUCTION													
Note 6	Street Construction (Excavation, gravels, asphalt)	m2	\$125	14,000	\$1,750,000	5,530	\$691,250	4,300	\$537,500	4,150	\$518,750	1,800	\$225,000
42.23	Mill & Asphalt Overlay (See Note 7)	m2	\$30	0	\$0	5,000	\$150,000	0	\$0	5,000	\$150,000	0	\$0
42.25	Street Removal	m2	\$10	7,000	\$70,000	1,250	\$12,500	1,025	\$10,250	630	\$6,300	300	\$3,000
43.2	Curb Installation	m	\$120	3,800	\$456,000	3,200	\$384,000	2,400	\$288,000	2,300	\$276,000	850	\$102,000
43.4	Curb Removal	m	\$20	3,500	\$70,000	3,100	\$62,000	2,550	\$51,000	2,100	\$42,000	850	\$17,000
44.1	Sidewalk Installation	m2	\$100	3,000	\$300,000	2,500	\$250,000	2,275	\$227,500	1,100	\$110,000	300	\$30,000
44.13	Sidewalk Removal	m2	\$15	4,700	\$70,500	4,700	\$70,500	4,150	\$62,250	2,800	\$42,000	1,350	\$20,250
44.14	Concrete Island	m2	\$130	1,100	\$143,000	1,050	\$136,500	380	\$49,400	1,000	\$130,000	330	\$42,900
44.15	Bus Pad Relocation	m2	\$200	130	\$26,000	130	\$26,000	130	\$26,000	130	\$26,000	130	\$26,000
44.16	Transit Bench / Shelter Relocation	each	\$1,500	1	\$1,500	1	\$1,500	1	\$1,500	1	\$1,500	1	\$1,500
44.17	A.T. Trail	m	\$130	1,800	\$234,000	1,800	\$234,000	1,800	\$234,000	1,720	\$223,600	1,720	\$223,600
45	Retaining Wall	m2	\$750	1,500	\$1,125,000	50	\$37,500	0	\$0	150	\$112,500	100	\$75,000
46.3	Signs	each	\$650	40	\$26,000	37	\$24,050	30	\$19,500	40	\$26,000	15	\$9,750
LANDSCAPING													
54.2	Tree Removal (< 400mm)	each	\$700	10	\$7,000	10	\$7,000	12	\$8,400	9	\$6,300	11	\$7,700
54.3	Tree Removal (> 400mm)	each	\$1,800	16	\$28,800	16	\$28,800	16	\$28,800	5	\$9,000	2	\$3,600
50	Topsoil & Sod	m2	\$15	6,000	\$90,000	5,000	\$75,000	3,750	\$56,250	3,500	\$52,500	2,500	\$37,500
57	Handrail / Fence	m	\$110	500	\$55,000	250	\$27,500	200	\$22,000	250	\$27,500	200	\$22,000
ADDITIONAL ITEMS													
60	Trench Excavation - Rock	m3	\$105	800	\$84,000	60	\$6,300	30	\$3,150	120	\$12,600	60	\$6,300
61	Trench Excavation - Unsuitable Material	m3	\$55	800	\$44,000	60	\$3,300	30	\$1,650	120	\$6,600	60	\$3,300
62	Replacement of Unsuitable Material	m3	\$60	800	\$48,000	60	\$3,600	30	\$1,800	120	\$7,200	60	\$3,600
65.1	Pavement Markings	LS	\$40,000	1	\$40,000	1	\$40,000	1	\$40,000	1	\$40,000	1	\$40,000
65.2	Removal of Existing Pavement Markings	LS	\$10,000	1	\$10,000	1	\$10,000	1	\$10,000	1	\$10,000	1	\$10,000
65.3	Red In-Lay Reserved Lane Symbol	each	\$5,000	8	\$40,000	10	\$50,000	8	\$40,000	9	\$45,000	3	\$15,000
ENVIRONMENTAL PROTECTION													
70	Environmental Protection Allowance	LS	\$20,000	1	\$20,000	1	\$20,000	1	\$20,000	1	\$20,000	1	\$20,000
ELECTRICAL													
85	Intersection Signals (Installation or Replacement)	LS	\$250,000	3	\$750,000	3	\$750,000	2	\$500,000	3	\$750,000	2	\$500,000
87	Street Lights	each	\$10,000	15	\$150,000	6	\$60,000	0	\$0	6	\$60,000	0	\$0
88	Traffic Signal Relocation	pole	\$10,000	4	\$40,000	4	\$40,000	8	\$80,000	2	\$20,000	4	\$40,000
89	Intersection Traffic Signal Removal	LS	\$50,000	1	\$50,000	0	\$0	0	\$0	0	\$0	0	\$0
90	Undergrounding Electrical at Overpass	LS	\$300,000	1	\$300,000	0	\$0	0	\$0	0	\$0	0	\$0
MISCELLANEOUS													
91	Guiderail / Jersey Barrier Installation	m	\$150	450	\$67,500	0	\$0	0	\$0	0	\$0	0	\$0
92	Natural Gas Pipe (Removal and Replacement)	m	\$350	200	\$70,000	0	\$0	0	\$0	0	\$0	0	\$0
93	Traffic Control	LS	Varies	1	\$600,000	1	\$250,000	1	\$150,000	1	\$250,000	1	\$100,000
94	O/H Reversing Lane Sign Structures	each	\$40,000	0	\$0	0	\$0	0	\$0	10	\$400,000	3	\$120,000
95	Bridge Structure	LS	\$3,000,000	1	\$3,000,000	0	\$0	0	\$0	0	\$0	0	\$0

OPTIONS

B1.1	High Investment Scenario
B1.2	High Investment with Medium HSC Scenario
B1.3	High Investment with Low HSC Scenario
B2	Medium Investment Scenario
B3	Low Investment Scenario

	Option B1.1	Option B1.2	Option B1.3	Option B2	Option B3
Sub-Total	\$12,471,500	\$3,973,560	\$2,809,250	\$3,783,150	\$1,881,600
Contingency (30%)	\$3,741,450	\$1,192,068	\$842,775	\$1,134,945	\$564,480
TOTAL COST (excl. HST)	\$16,213,000	\$5,166,000	\$3,652,000	\$4,918,000	\$2,446,000

APPENDIX

E SAMPLE DELAY AND PAYBACK CALCULATIONS

Using the Net User Delay Methodology developed in the *Transit Priority Measures Study* (WSP, 2016) as well the Transit ridership data and delay estimates obtained for each location it is possible to calculate the net road user delay during the subject peak hour as well as the payback periods associated with each measure. These equations are included below.

$$\text{Net Change in Road User Delay} = \text{Net Transit User Delay} + \text{Net Non Transit User Delay}$$

Where:

$$\text{Net Change in Transit User Delay} = \text{Delay/Transit Vehicle} \times \# \text{ Transit Vehicles} \times \text{Average Ridership per Transit Vehicle}$$

And,

$$\text{Net Change in Non Transit User Delay} = \text{Delay/Non Transit Vehicle} \times \# \text{ Non Transit Vehicles} \times \text{Average Vehicle Occupancy}$$

Note: Delay reductions will be a negative value while delay increases will be a positive value.

$$\text{Daily Change in Cost to Transit}$$

$$= \text{Average Change in Delay/Transit Vehicle} \times \# \text{ Transit Vehicles} \times \text{Cost/hour for Transit Vehicle}$$

$$\text{Annual Change in Cost to Transit} = \text{Daily Change in Cost to Transit} \times \text{Days/Year TPM is in Use}$$

$$\text{Daily Change in Cost to Public} = \text{Daily Change in Person Cost} + \text{Daily Change in nonTransit Vehicle Cost}$$

Where

$$\text{Daily Change in Person Cost}$$

$$= \text{Net Change in Road User Delay} \times \# \text{ hours TPM will be in effect per day} \times \text{Cost/hour for Road User}$$

$$\text{Daily Change in nonTransit Vehicle Cost}$$

$$= \text{Average delay change per nonTransit user} \times \# \text{ of NonTransit vehicles} \times \text{Cost /hour for nonTransit Vehicle}$$

$$\text{Annual Change in Cost to Public} = \text{Daily Change in Cost to Public} \times \text{Days/Year TPM is in Use}$$

$$\text{Payback Period} = \frac{\text{TPM Capital Cost}}{\text{Annual Cost Savings to Transit} + \text{Annual Cost Savings to Public} - \text{Annual Change in Operating Cost}}$$

APPENDIX

F

GOTTINGEN

STREET

INTERSECTION

CAPACITY

ANALYSIS

Table F-1 - Gottingen Street AM Peak Hour Intersection Analysis

Intersection		AM Peak Hour											
		Existing Conditions					Preferred Option						
		Scenario	Approach ¹	Delay	V/C	LOS	Queue	Option	Approach ¹	Delay	V/C	LOS	Queue
Gottingen Street @	North	Existing (Page F-2)	EB-LTR	49.7	0.90	D	85.2	High Invest ² (Page F-8)	EB-LTR	49.7	0.90	D	85.2
			WB-L	47.0	0.91	D	140.9		WB-L	47.0	0.91	D	140.9
			WB-T	23.7	0.69	C	129.8		WB-T	23.7	0.69	C	129.8
			WB-R	3.0	0.32	A	12.4		WB-R	3.0	0.32	A	12.4
			NB-T	23.1	0.36	C	40.0		NB-T	25.3	0.36	C	43.4
			NB-R	4.5	0.26	A	11.0		NB-R	7.3	0.26	A	13.9
			SB-L	53.0	0.87	D	83.1		SB-L	53.0	0.87	D	83.1
			SB-T	39.3	0.81	D	90.8		SB-LTR	39.3	0.81	D	90.8
	Cornwallis	Existing (Page F-3)	EB-LTR	40.8	0.72	D	81.6	High Invest ³ (Page F-9)	EB-TR	40.8	0.72	D	81.6
			WB-LTR	25.9	0.28	C	29.2		WB-LTR	29.9	0.29	C	31.8
			NB-LTR	7.6	0.22	A	24.7		NB-TL	7.6	0.18	A	21.2
			SB-LTR	21.6	0.82	C	164.8		NB-R	2.7	0.04	A	3.6
	Cogswell	Existing (Page F-4)	EB-LT	25.4	0.35	C	35.6	High Invest ⁴ (Page F-10)	EB-LT	25.4	0.35	C	35.6
			EB-R	2.5	0.14	A	3.6		EB-R	2.5	0.13	A	3.6
			WB-L	21.8	0.02	C	3.1		WB-L	21.8	0.02	C	3.1
			WB-T	23.8	0.18	C	24.0		WB-T	23.8	0.18	C	24.0
			WB-R	2.4	0.12	A	3.6		WB-R	2.4	0.12	A	3.6
			NB-L	12.6	0.34	B	22.9		NB-L	12.6	0.34	B	22.9
			NB-TR	11.0	0.15	B	17.6		NB-TR	11.0	0.15	B	17.6
			SB-L	24.8	0.47	C	48.8		SB-L	24.8	0.47	C	48.8
	SB-TR	25.0	0.55	C	72.0	SB-TR	25.0	0.55	C	72.0			

Notes:

1. Gottingen Street is north/south for the full corridor
2. Shortening of northbound right turn lane at North intersection to provide transit priority lane.
3. Provide northbound transit lane.
4. No Impact to Operations at this intersection

Table F-2 - Gottingen Street PM Peak Hour Intersection Analysis

Intersection		PM Peak Hour											
		Existing Conditions					Preferred Option						
		Scenario	Approach ¹	Delay	V/C	LOS	Queue	Option	Approach ¹	Delay	V/C	LOS	Queue
Gottingen Street @	North	Existing (Page F-5)	EB-LTR	85.4	0.94	F	97.6	High Invest ² (Page F-11)	EB-LTR	85.4	0.94	F	97.6
			WB-L	48.7	0.89	D	72.4		WB-L	48.7	0.89	D	72.4
			WB-T	32.1	0.77	C	129.3		WB-T	32.1	0.77	C	129.3
			WB-R	8.8	0.64	A	41.7		WB-R	8.8	0.64	A	41.7
			NB-T	45.0	0.79	D	99.2		NB-T	70.1	0.79	D	96.6
			NB-R	61.1	0.99	E	123.6		NB-R	54.5	0.99	D	119.9
			SB-L	23.7	0.66	C	39.2		SB-L	23.7	0.66	C	39.2
			SB-T	17.0	0.37	B	40.9		SB-TR	17.0	0.37	B	40.9
	Cornwallis	Existing (Page F-6)	EB-LTR	25.1	0.36	C	35.8	High Invest ³ (Page F-12)	EB-TR	25.1	0.36	C	35.8
			WB-LTR	27.3	0.53	C	65.6		WB-LTR	29.4	0.55	C	69.1
			NB-LTR	17.7	0.62	B	96.0		NB-LT	15.3	0.52	B	76.6
			SB-LTR	14.4	0.58	B	54.4		NB-R	6.0	0.08	A	8.6
	Cogswell	Existing (Page F-7)	EB-LT	28.2	0.35	C	29.9	High Invest ⁴ (Page F-13)	EB-LT	28.2	0.35	C	29.9
			EB-R	2.2	0.12	A	2.4		EB-R	2.2	0.12	A	2.4
			WB-L	24.6	0.04	C	5.3		WB-L	24.6	0.04	C	5.3
			WB-T	34.5	0.59	C	73.3		WB-T	34.5	0.59	C	73.3
			WB-R	6.2	0.33	A	12.6		WB-R	6.2	0.33	A	12.6
			NB-L	25.9	0.79	C	72.5		NB-L	25.9	0.79	C	72.5
			NB-TR	15.3	0.43	B	52.5		NB-TR	15.3	0.43	B	52.5
			SB-L	23.2	0.25	C	21.9		SB-L	23.2	0.25	C	21.9
	SB-TR	22.0	0.39	C	46.5	SB-TR	22.0	0.39	C	46.5			

Notes:

1. Gottingen Street is north/south for the full corridor
2. Shortening of northbound right turn lane at North intersection to provide transit priority lane.
3. Provide northbound transit lane.
4. No Impact to Operations at this intersection

Halifax Transit Priority Corridors 1: Gottingen Street & North Street

Lane Group	EBL	EBT	EBR	WBL	WBT	WBR	NBL	NBT	NBR	SBL	SBT	SBR
Lane Configurations												
Traffic Volume (vph)	5	440	25	475	595	255	0	195	140	280	375	15
Future Volume (vph)	5	440	25	475	595	255	0	195	140	280	375	15
Satd. Flow (prot)	0	2785	0	1639	1736	1467	0	1680	1428	1578	1482	0
Flt Permitted		0.946		0.187						0.613		
Satd. Flow (perm)	0	2636	0	309	1736	1361	0	1680	1360	991	1482	0
Satd. Flow (RTOR)		4				266			146		3	
Lane Group Flow (vph)	0	489	0	495	620	266	0	203	146	292	407	0
Turn Type	Perm	NA		pm+pt	NA	Perm		NA	Perm	Perm	NA	
Protected Phases		8		7	4			6			2	
Permitted Phases	8			4		4			6	2		
Total Split (s)	25.0	25.0		23.0	48.0	48.0		42.0	42.0	42.0	42.0	
Total Lost Time (s)		6.3		3.0	6.3	6.3		6.7	6.7	6.7	6.7	
Act Effct Green (s)		18.4		49.7	46.4	46.4		30.6	30.6	30.6	30.6	
Actuated g/C Ratio		0.20		0.55	0.52	0.52		0.34	0.34	0.34	0.34	
v/c Ratio		0.90		0.91	0.69	0.32		0.36	0.26	0.87	0.81	
Control Delay		49.7		47.0	23.1	3.0		23.1	4.5	53.0	39.3	
Queue Delay		0.0		0.0	0.6	0.0		0.0	0.0	0.0	0.0	
Total Delay		49.7		47.0	23.7	3.0		23.1	4.5	53.0	39.3	
LOS		D		D	C	A		C	A	D	D	
Approach Delay		49.7			28.0			15.3			45.0	
Approach LOS		D			C			B			D	
Queue Length 50th (m)		30.2		~71.2	81.9	0.0		24.8	0.0	44.4	59.7	
Queue Length 95th (m)		#85.2		#140.9	129.8	12.4		40.0	11.0	#83.1	90.8	
Internal Link Dist (m)		72.5			71.6			146.8			484.7	
Turn Bay Length (m)										60.0		
Base Capacity (vph)		550		541	895	831		658	622	388	583	
Starvation Cap Reductn		0		0	68	0		0	0	0	0	
Spillback Cap Reductn		0		0	0	0		0	0	0	0	
Storage Cap Reductn		0		0	0	0		0	0	0	0	
Reduced v/c Ratio		0.89		0.91	0.75	0.32		0.31	0.23	0.75	0.70	

Intersection Summary

Cycle Length: 90
 Actuated Cycle Length: 90
 Offset: 0 (0%), Referenced to phase 2:SBTL and 6:NBT, Start of Green
 Control Type: Actuated-Coordinated
 Maximum v/c Ratio: 0.91
 Intersection Signal Delay: 34.2
 Intersection Capacity Utilization 115.8%
 Analysis Period (min) 15
 ~ Volume exceeds capacity, queue is theoretically infinite.
 Queue shown is maximum after two cycles.
 # 95th percentile volume exceeds capacity, queue may be longer.
 Queue shown is maximum after two cycles.

Splits and Phases: 1: Gottingen Street & North Street

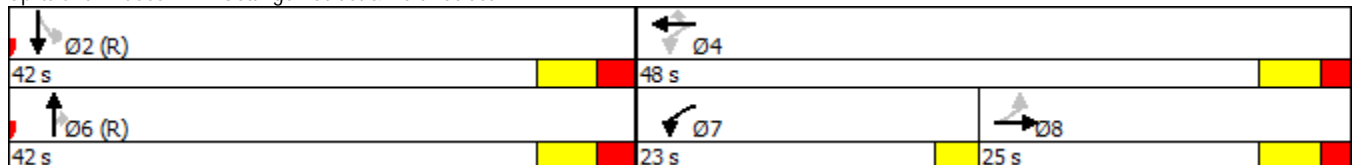

Lane Group	EBL	EBT	EBR	WBL	WBT	WBR	NBL	NBT	NBR	SBL	SBT	SBR
Lane Configurations												
Traffic Volume (vph)	25	215	40	10	75	25	5	185	15	60	650	40
Future Volume (vph)	25	215	40	10	75	25	5	185	15	60	650	40
Satd. Flow (prot)	0	1800	0	0	1778	0	0	1679	0	0	1679	0
Flt Permitted		0.963			0.962			0.982			0.955	
Satd. Flow (perm)	0	1740	0	0	1717	0	0	1650	0	0	1609	0
Satd. Flow (RTOR)		9			16			9			6	
Lane Group Flow (vph)	0	311	0	0	122	0	0	229	0	0	833	0
Turn Type	Perm	NA		Perm	NA		Perm	NA		Perm	NA	
Protected Phases		4			4			2			2	
Permitted Phases	4			4			2			2		
Total Split (s)	28.0	28.0		28.0	28.0		62.0	62.0		62.0	62.0	
Total Lost Time (s)		5.9			5.9			5.5			5.5	
Act Effct Green (s)		22.1			22.1			56.5			56.5	
Actuated g/C Ratio		0.25			0.25			0.63			0.63	
v/c Ratio		0.72			0.28			0.22			0.82	
Control Delay		40.8			25.9			7.6			21.6	
Queue Delay		0.0			0.0			0.0			0.0	
Total Delay		40.8			25.9			7.6			21.6	
LOS		D			C			A			C	
Approach Delay		40.8			25.9			7.6			21.6	
Approach LOS		D			C			A			C	
Queue Length 50th (m)		47.9			14.8			14.8			99.6	
Queue Length 95th (m)		#81.6			29.2			24.7			#164.8	
Internal Link Dist (m)		133.8			116.8			279.1			419.4	
Turn Bay Length (m)												
Base Capacity (vph)		434			433			1039			1012	
Starvation Cap Reductn		0			0			0			0	
Spillback Cap Reductn		0			0			0			0	
Storage Cap Reductn		0			0			0			0	
Reduced v/c Ratio		0.72			0.28			0.22			0.82	

Intersection Summary

Cycle Length: 90
 Actuated Cycle Length: 90
 Offset: 0 (0%), Referenced to phase 2:NBSB, Start of Green
 Control Type: Pretimed
 Maximum v/c Ratio: 0.82
 Intersection Signal Delay: 23.8
 Intersection Capacity Utilization 84.8%
 Analysis Period (min) 15
 # 95th percentile volume exceeds capacity, queue may be longer.
 Queue shown is maximum after two cycles.

Splits and Phases: 2: Gottingen Street & Cornwallis Street

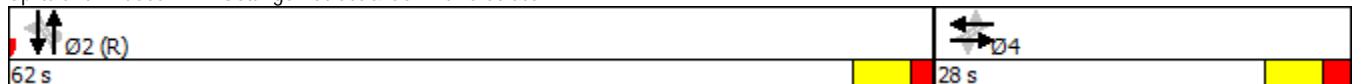

Halifax Transit Priority Corridors

3: Gottingen Street & Cogswell Street

Lane Group	EBL	EBT	EBR	WBL	WBT	WBR	NBL	NBT	NBR	SBL	SBT	SBR
Lane Configurations												
Traffic Volume (vph)	20	295	55	5	90	55	145	90	15	200	280	40
Future Volume (vph)	20	295	55	5	90	55	145	90	15	200	280	40
Satd. Flow (prot)	0	3140	1362	1575	1658	1409	1575	1384	0	1575	1504	0
Flt Permitted		0.934		0.546			0.427			0.685		
Satd. Flow (perm)	0	2932	1174	837	1658	1291	692	1384	0	1112	1504	0
Satd. Flow (RTOR)			94			94		13			9	
Lane Group Flow (vph)	0	335	59	5	96	59	154	112	0	213	341	0
Turn Type	Perm	NA	Perm	Perm	NA	Perm	pm+pt	NA		Perm	NA	
Protected Phases		4			4		1	6			2	
Permitted Phases	4		4	4		4	6			2		
Total Split (s)	38.0	38.0	38.0	38.0	38.0	38.0	11.0	57.0		46.0	46.0	
Total Lost Time (s)		6.7	6.7	6.7	6.7	6.7	4.0	7.2		7.2	7.2	
Act Effct Green (s)		31.3	31.3	31.3	31.3	31.3	53.0	49.8		38.8	38.8	
Actuated g/C Ratio		0.33	0.33	0.33	0.33	0.33	0.56	0.52		0.41	0.41	
v/c Ratio		0.35	0.13	0.02	0.18	0.12	0.34	0.15		0.47	0.55	
Control Delay		25.4	2.5	21.8	23.8	2.4	12.6	11.0		24.8	25.0	
Queue Delay		0.0	0.0	0.0	0.0	0.0	0.0	0.0		0.0	0.0	
Total Delay		25.4	2.5	21.8	23.8	2.4	12.6	11.0		24.8	25.0	
LOS		C	A	C	C	A	B	B		C	C	
Approach Delay		22.0			15.9			11.9			24.9	
Approach LOS		C			B			B			C	
Queue Length 50th (m)		24.2	0.0	0.6	12.4	0.0	13.0	8.8		28.0	45.4	
Queue Length 95th (m)		35.6	3.6	3.1	24.0	3.6	22.9	17.6		48.8	72.0	
Internal Link Dist (m)		66.6			131.0			105.8			279.1	
Turn Bay Length (m)			30.0			50.0	50.0			50.0		
Base Capacity (vph)		966	449	275	546	488	451	731		454	619	
Starvation Cap Reductn		0	0	0	0	0	0	0		0	0	
Spillback Cap Reductn		0	0	0	0	0	0	0		0	0	
Storage Cap Reductn		0	0	0	0	0	0	0		0	0	
Reduced v/c Ratio		0.35	0.13	0.02	0.18	0.12	0.34	0.15		0.47	0.55	

Intersection Summary

Cycle Length: 95
 Actuated Cycle Length: 95
 Offset: 6 (6%), Referenced to phase 2:SBTL and 6:NBTL, Start of Green
 Control Type: Actuated-Coordinated
 Maximum v/c Ratio: 0.55
 Intersection Signal Delay: 20.5
 Intersection Capacity Utilization 98.0%
 Analysis Period (min) 15

Intersection LOS: C
 ICU Level of Service F

Splits and Phases: 3: Gottingen Street & Cogswell Street

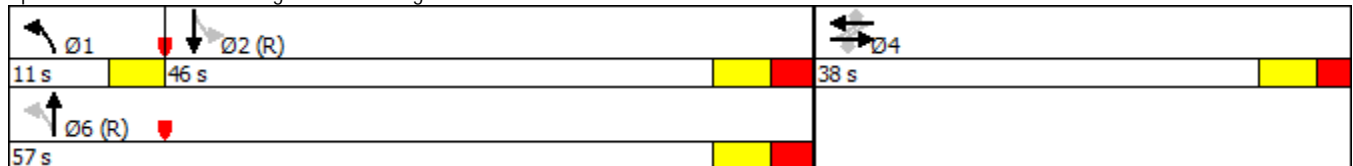

Halifax Transit Priority Corridors 1: Gottingen Street & North Street

Lane Group	EBL	EBT	EBR	WBL	WBT	WBR	NBL	NBT	NBR	SBL	SBT	SBR
Lane Configurations												
Traffic Volume (vph)	15	645	15	245	495	445	0	335	530	230	195	20
Future Volume (vph)	15	645	15	245	495	445	0	335	530	230	195	20
Satd. Flow (prot)	0	3589	0	1655	1749	1481	0	1339	1062	1580	1383	0
Flt Permitted		0.934		0.167						0.365		
Satd. Flow (perm)	0	3353	0	277	1749	1331	0	1339	1019	598	1383	0
Satd. Flow (RTOR)		2				379			356		8	
Lane Group Flow (vph)	0	733	0	266	538	484	0	364	576	250	234	0
Turn Type	Perm	NA		pm+pt	NA	Perm		NA	Perm	pm+pt	NA	
Protected Phases		8		7	4			6		5	2	
Permitted Phases	8			4		4			6	2		
Total Split (s)	27.0	27.0		14.0	41.0	41.0		39.0	39.0	10.0	49.0	
Total Lost Time (s)		6.3		3.0	6.3	6.3		6.7	6.7	3.0	6.7	
Act Effct Green (s)		21.0		39.1	35.8	35.8		31.1	31.1	44.9	41.2	
Actuated g/C Ratio		0.23		0.43	0.40	0.40		0.35	0.35	0.50	0.46	
v/c Ratio		0.94		0.89	0.77	0.64		0.79	0.99	0.66	0.37	
Control Delay		40.5		48.7	32.1	8.8		45.0	53.8	23.7	17.0	
Queue Delay		44.9		0.0	0.0	0.0		0.0	7.3	0.0	0.0	
Total Delay		85.4		48.7	32.1	8.8		45.0	61.1	23.7	17.0	
LOS		F		D	C	A		D	E	C	B	
Approach Delay		85.4			26.8			54.9			20.5	
Approach LOS		F			C			D			C	
Queue Length 50th (m)		52.7		31.3	82.0	13.5		63.6	64.6	23.8	23.8	
Queue Length 95th (m)		#97.6		m#72.4	m#129.3	m41.7		#99.2	#123.6	39.2	40.9	
Internal Link Dist (m)		72.5			71.6			338.4			95.8	
Turn Bay Length (m)									300.0	60.0		
Base Capacity (vph)		782		300	695	757		480	593	376	654	
Starvation Cap Reductn		0		0	0	0		0	0	0	0	
Spillback Cap Reductn		144		0	0	0		0	20	0	0	
Storage Cap Reductn		0		0	0	0		0	0	0	0	
Reduced v/c Ratio		1.15		0.89	0.77	0.64		0.76	1.01	0.66	0.36	

Intersection Summary

Cycle Length: 90
 Actuated Cycle Length: 90
 Offset: 17 (19%), Referenced to phase 2:SBTL and 6:NBT, Start of Green
 Control Type: Actuated-Coordinated
 Maximum v/c Ratio: 0.99
 Intersection Signal Delay: 46.0
 Intersection Capacity Utilization 106.5%
 Analysis Period (min) 15
 # 95th percentile volume exceeds capacity, queue may be longer.
 Queue shown is maximum after two cycles.
 m Volume for 95th percentile queue is metered by upstream signal.

Splits and Phases: 1: Gottingen Street & North Street

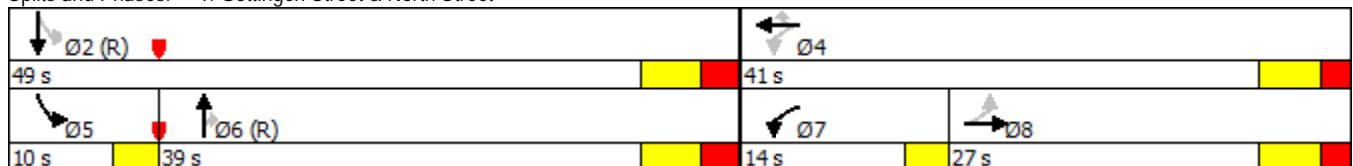

Lane Group	EBL	EBT	EBR	WBL	WBT	WBR	NBL	NBT	NBR	SBL	SBT	SBR
Lane Configurations												
Traffic Volume (vph)	55	70	15	10	200	70	20	480	10	35	365	45
Future Volume (vph)	55	70	15	10	200	70	20	480	10	35	365	45
Satd. Flow (prot)	0	1780	0	0	1776	0	0	1689	0	0	1667	0
Flt Permitted		0.735			0.989			0.973			0.930	
Satd. Flow (perm)	0	1334	0	0	1760	0	0	1646	0	0	1556	0
Satd. Flow (RTOR)		7			20			2			10	
Lane Group Flow (vph)	0	156	0	0	311	0	0	566	0	0	495	0
Turn Type	Perm	NA		Perm	NA		Perm	NA		Perm	NA	
Protected Phases		4			4			2			2	
Permitted Phases	4			4			2			2		
Total Split (s)	35.0	35.0		35.0	35.0		55.0	55.0		55.0	55.0	
Total Lost Time (s)		5.9			5.9			5.5			5.5	
Act Effct Green (s)		29.1			29.1			49.5			49.5	
Actuated g/C Ratio		0.32			0.32			0.55			0.55	
v/c Ratio		0.36			0.53			0.62			0.58	
Control Delay		25.1			27.3			17.7			14.4	
Queue Delay		0.0			0.0			0.0			0.0	
Total Delay		25.1			27.3			17.7			14.4	
LOS		C			C			B			B	
Approach Delay		25.1			27.3			17.7			14.4	
Approach LOS		C			C			B			B	
Queue Length 50th (m)		19.5			40.7			62.6			42.8	
Queue Length 95th (m)		35.8			65.6			96.0			m54.4	
Internal Link Dist (m)		136.3			95.8			282.9			131.2	
Turn Bay Length (m)												
Base Capacity (vph)		436			582			906			860	
Starvation Cap Reductn		0			0			0			0	
Spillback Cap Reductn		0			0			0			0	
Storage Cap Reductn		0			0			0			0	
Reduced v/c Ratio		0.36			0.53			0.62			0.58	

Intersection Summary

Cycle Length: 90
 Actuated Cycle Length: 90
 Offset: 0 (0%), Referenced to phase 2:NBSB, Start of Green
 Control Type: Pretimed
 Maximum v/c Ratio: 0.62
 Intersection Signal Delay: 19.3
 Intersection Capacity Utilization 73.4%
 Analysis Period (min) 15
 m Volume for 95th percentile queue is metered by upstream signal.

Intersection LOS: B
 ICU Level of Service D

Splits and Phases: 2: Gottingen Street & Cornwallis Street



Halifax Transit Priority Corridors 3: Gottingen Street & Cogswell Street

Lane Group	EBL	EBT	EBR	WBL	WBT	WBR	NBL	NBT	NBR	SBL	SBT	SBR
Lane Configurations												
Traffic Volume (vph)	50	175	45	10	265	140	400	270	15	75	145	60
Future Volume (vph)	50	175	45	10	265	140	400	270	15	75	145	60
Satd. Flow (prot)	0	3139	1362	1575	1658	1409	1575	1394	0	1550	1532	0
Flt Permitted		0.748		0.592			0.526			0.563		
Satd. Flow (perm)	0	2338	1217	921	1658	1215	848	1394	0	895	1532	0
Satd. Flow (RTOR)			89			161		4			24	
Lane Group Flow (vph)	0	258	52	11	305	161	460	327	0	86	236	0
Turn Type	Perm	NA	Perm	Perm	NA	Perm	pm+pt	NA		Perm	NA	
Protected Phases		4			4		1	6			2	
Permitted Phases	4		4	4		4	6			2		
Total Split (s)	38.0	38.0	38.0	38.0	38.0	38.0	16.0	62.0		46.0	46.0	
Total Lost Time (s)		6.7	6.7	6.7	6.7	6.7	4.0	7.2		7.2	7.2	
Act Effct Green (s)		31.3	31.3	31.3	31.3	31.3	58.0	54.8		38.8	38.8	
Actuated g/C Ratio		0.31	0.31	0.31	0.31	0.31	0.58	0.55		0.39	0.39	
v/c Ratio		0.35	0.12	0.04	0.59	0.33	0.79	0.43		0.25	0.39	
Control Delay		28.2	2.2	24.6	34.5	6.2	25.9	15.3		23.2	22.0	
Queue Delay		0.0	0.0	0.0	0.0	0.0	0.0	0.0		0.0	0.0	
Total Delay		28.2	2.2	24.6	34.5	6.2	25.9	15.3		23.2	22.0	
LOS		C	A	C	C	A	C	B		C	C	
Approach Delay		23.9			24.7			21.5			22.3	
Approach LOS		C			C			C			C	
Queue Length 50th (m)		20.2	0.0	1.5	49.5	0.0	49.5	34.9		11.1	28.9	
Queue Length 95th (m)		29.9	2.4	5.3	73.3	12.6	#72.5	52.5		21.9	46.5	
Internal Link Dist (m)		66.6			100.9			105.8			282.9	
Turn Bay Length (m)			30.0			50.0	50.0			50.0		
Base Capacity (vph)		731	442	288	518	490	579	765		347	609	
Starvation Cap Reductn		0	0	0	0	0	0	0		0	0	
Spillback Cap Reductn		0	0	0	0	0	0	0		0	0	
Storage Cap Reductn		0	0	0	0	0	0	0		0	0	
Reduced v/c Ratio		0.35	0.12	0.04	0.59	0.33	0.79	0.43		0.25	0.39	

Intersection Summary

Cycle Length: 100
 Actuated Cycle Length: 100
 Offset: 17 (17%), Referenced to phase 2:SBTL and 6:NBTL, Start of Green
 Control Type: Actuated-Coordinated
 Maximum v/c Ratio: 0.79
 Intersection Signal Delay: 22.8
 Intersection Capacity Utilization 117.0%
 Analysis Period (min) 15
 # 95th percentile volume exceeds capacity, queue may be longer.
 Queue shown is maximum after two cycles.

Splits and Phases: 3: Gottingen Street & Cogswell Street

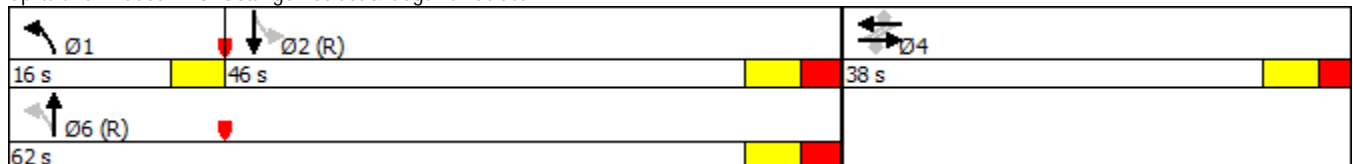

Halifax Transit Priority Corridors 1: Gottingen Street & North Street

Lane Group	EBL	EBT	WBL	WBT	WBR	NBT	NBR	SBL	SBT
Lane Configurations									
Traffic Volume (vph)	5	440	475	595	255	195	140	280	375
Future Volume (vph)	5	440	475	595	255	195	140	280	375
Lane Group Flow (vph)	0	489	495	620	266	203	146	292	407
Turn Type	Perm	NA	pm+pt	NA	Perm	NA	Perm	Perm	NA
Protected Phases		8	7	4		6			2
Permitted Phases	8		4		4		6	2	
Detector Phase	8	8	7	4	4	6	6	2	2
Switch Phase									
Minimum Initial (s)	10.0	10.0	7.0	10.0	10.0	10.0	10.0	10.0	10.0
Minimum Split (s)	25.0	25.0	10.0	48.0	48.0	42.0	42.0	42.0	42.0
Total Split (s)	25.0	25.0	23.0	48.0	48.0	42.0	42.0	42.0	42.0
Total Split (%)	27.8%	27.8%	25.6%	53.3%	53.3%	46.7%	46.7%	46.7%	46.7%
Yellow Time (s)	4.1	4.1	3.0	4.1	4.1	4.1	4.1	4.1	4.1
All-Red Time (s)	2.2	2.2	0.0	2.2	2.2	2.6	2.6	2.6	2.6
Lost Time Adjust (s)		0.0	0.0	0.0	0.0	0.0	0.0	0.0	0.0
Total Lost Time (s)		6.3	3.0	6.3	6.3	6.7	6.7	6.7	6.7
Lead/Lag	Lag	Lag	Lead						
Lead-Lag Optimize?									
Recall Mode	None	None	None	None	None	C-Min	C-Min	C-Min	C-Min
Act Effct Green (s)		18.4	49.7	46.4	46.4	30.6	30.6	30.6	30.6
Actuated g/C Ratio		0.20	0.55	0.52	0.52	0.34	0.34	0.34	0.34
v/c Ratio		0.90	0.91	0.69	0.32	0.36	0.26	0.87	0.81
Control Delay		49.7	47.0	23.1	3.0	25.3	7.3	53.0	39.3
Queue Delay		0.0	0.0	0.6	0.0	0.0	0.0	0.0	0.0
Total Delay		49.7	47.0	23.7	3.0	25.3	7.3	53.0	39.3
LOS		D	D	C	A	C	A	D	D
Approach Delay		49.7		28.0		17.8			45.0
Approach LOS		D		C		B			D
Queue Length 50th (m)		30.2	-71.2	81.9	0.0	26.8	0.0	44.4	59.7
Queue Length 95th (m)		#85.2	#140.9	129.8	12.4	m43.4	m13.9	#83.1	90.8
Internal Link Dist (m)		72.5		71.6		146.8			484.7
Turn Bay Length (m)							60.0		
Base Capacity (vph)		550	541	895	831	658	622	388	583
Starvation Cap Reductn		0	0	68	0	0	0	0	0
Spillback Cap Reductn		0	0	0	0	0	0	0	0
Storage Cap Reductn		0	0	0	0	0	0	0	0
Reduced v/c Ratio		0.89	0.91	0.75	0.32	0.31	0.23	0.75	0.70

Intersection Summary

Cycle Length: 90
 Actuated Cycle Length: 90
 Offset: 0 (0%), Referenced to phase 2:SBTL and 6:NBT, Start of Green
 Natural Cycle: 90
 Control Type: Actuated-Coordinated
 Maximum v/c Ratio: 0.91
 Intersection Signal Delay: 34.5
 Intersection Capacity Utilization 115.8%
 Analysis Period (min) 15
 ~ Volume exceeds capacity, queue is theoretically infinite.
 Queue shown is maximum after two cycles.
 # 95th percentile volume exceeds capacity, queue may be longer.
 Queue shown is maximum after two cycles.
 m Volume for 95th percentile queue is metered by upstream signal.

Splits and Phases: 1: Gottingen Street & North Street

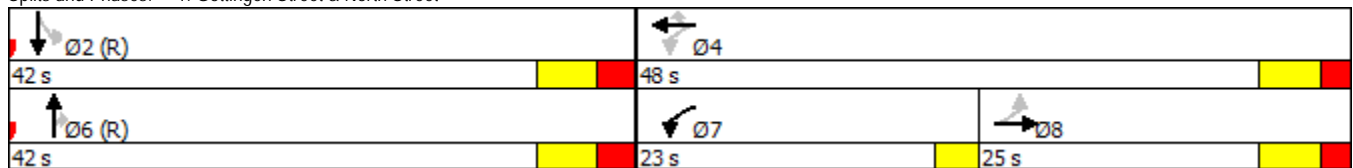

Halifax Transit Priority Corridors

2: Gottingen Street & Cornwallis Street

Lane Group	EBL2	EBT	WBL	WBT	NBL	NBT	NBR	SBL	SBT
Lane Configurations									
Traffic Volume (vph)	25	215	10	75	5	165	20	60	650
Future Volume (vph)	25	215	10	75	5	165	20	60	650
Lane Group Flow (vph)	0	311	0	122	0	189	39	0	833
Turn Type	Perm	NA	Perm	NA	Perm	NA	Perm	Perm	NA
Protected Phases		4		4		2			2
Permitted Phases	4		4		2		2	2	
Minimum Split (s)	28.0	28.0	28.0	28.0	28.0	28.0	28.0	28.0	28.0
Total Split (s)	28.0	28.0	28.0	28.0	62.0	62.0	62.0	62.0	62.0
Total Split (%)	31.1%	31.1%	31.1%	31.1%	68.9%	68.9%	68.9%	68.9%	68.9%
Yellow Time (s)	3.9	3.9	3.9	3.9	3.9	3.9	3.9	3.9	3.9
All-Red Time (s)	2.0	2.0	2.0	2.0	1.6	1.6	1.6	1.6	1.6
Lost Time Adjust (s)		0.0		0.0		0.0		0.0	0.0
Total Lost Time (s)		5.9		5.9		5.5		5.5	5.5
Lead/Lag									
Lead-Lag Optimize?									
Act Effct Green (s)		22.1		22.1		56.5		56.5	56.5
Actuated g/C Ratio		0.25		0.25		0.63		0.63	0.63
v/c Ratio		0.72		0.29		0.18		0.04	0.82
Control Delay		40.8		29.9		7.6		2.7	24.0
Queue Delay		0.0		0.0		0.0		0.0	0.0
Total Delay		40.8		29.9		7.6		2.7	24.0
LOS		D		C		A		A	C
Approach Delay		40.8		29.9		6.7			24.0
Approach LOS		D		C		A			C
Queue Length 50th (m)		47.9		17.2		12.4		0.3	140.7
Queue Length 95th (m)		#81.6		31.8		21.2		3.6	m171.5
Internal Link Dist (m)		133.8		116.8		279.1			419.4
Turn Bay Length (m)								85.0	
Base Capacity (vph)		434		421		1043		996	1016
Starvation Cap Reductn		0		0		0		0	0
Spillback Cap Reductn		0		0		0		0	0
Storage Cap Reductn		0		0		0		0	0
Reduced v/c Ratio		0.72		0.29		0.18		0.04	0.82

Intersection Summary

Cycle Length: 90
 Actuated Cycle Length: 90
 Offset: 0 (0%), Referenced to phase 2:NBSB, Start of Green
 Natural Cycle: 75
 Control Type: Pretimed
 Maximum v/c Ratio: 0.82
 Intersection Signal Delay: 25.3
 Intersection Capacity Utilization 82.8%
 Analysis Period (min) 15
 # 95th percentile volume exceeds capacity, queue may be longer.
 Queue shown is maximum after two cycles.
 m Volume for 95th percentile queue is metered by upstream signal.

Intersection LOS: C
 ICU Level of Service E

Splits and Phases: 2: Gottingen Street & Cornwallis Street

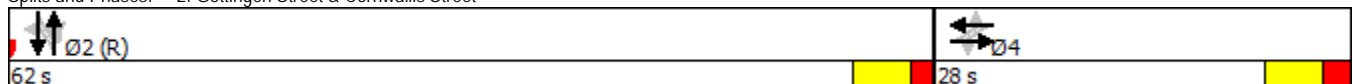

Halifax Transit Priority Corridors 3: Gottingen Street & Cogswell Street

Lane Group	EBL	EBT	EBR	WBL	WBT	WBR	NBL	NBT	SBL	SBT
Lane Configurations										
Traffic Volume (vph)	20	295	55	5	90	55	145	90	200	280
Future Volume (vph)	20	295	55	5	90	55	145	90	200	280
Lane Group Flow (vph)	0	335	59	5	96	59	154	112	213	341
Turn Type	Perm	NA	Perm	Perm	NA	Perm	pm+pt	NA	Perm	NA
Protected Phases		4			4		1	6		2
Permitted Phases	4		4	4		4	6		2	
Detector Phase	4	4		4	4		1	6	2	2
Switch Phase										
Minimum Initial (s)	7.0	7.0	7.0	7.0	7.0	7.0	7.0	7.0	7.0	7.0
Minimum Split (s)	36.7	36.7	36.7	36.7	36.7	36.7	11.0	44.2	44.2	44.2
Total Split (s)	38.0	38.0	38.0	38.0	38.0	38.0	11.0	57.0	46.0	46.0
Total Split (%)	40.0%	40.0%	40.0%	40.0%	40.0%	40.0%	11.6%	60.0%	48.4%	48.4%
Yellow Time (s)	4.1	4.1	4.1	4.1	4.1	4.1	4.0	4.1	4.1	4.1
All-Red Time (s)	2.6	2.6	2.6	2.6	2.6	2.6	0.0	3.1	3.1	3.1
Lost Time Adjust (s)		0.0	0.0	0.0	0.0	0.0	0.0	0.0	0.0	0.0
Total Lost Time (s)		6.7	6.7	6.7	6.7	6.7	4.0	7.2	7.2	7.2
Lead/Lag							Lead		Lag	Lag
Lead-Lag Optimize?										
Recall Mode	Max	Max	Max	Max	Max	Max	Max	C-Max	C-Max	C-Max
Act Effct Green (s)		31.3	31.3	31.3	31.3	31.3	53.0	49.8	38.8	38.8
Actuated g/C Ratio		0.33	0.33	0.33	0.33	0.33	0.56	0.52	0.41	0.41
v/c Ratio		0.35	0.13	0.02	0.18	0.12	0.34	0.15	0.47	0.55
Control Delay		25.4	2.5	21.8	23.8	2.4	12.6	11.0	24.8	25.0
Queue Delay		0.0	0.0	0.0	0.0	0.0	0.0	0.0	0.0	0.0
Total Delay		25.4	2.5	21.8	23.8	2.4	12.6	11.0	24.8	25.0
LOS		C	A	C	C	A	B	B	C	C
Approach Delay		22.0			15.9			11.9		24.9
Approach LOS		C			B			B		C
Queue Length 50th (m)		24.2	0.0	0.6	12.4	0.0	13.0	8.8	28.0	45.4
Queue Length 95th (m)		35.6	3.6	3.1	24.0	3.6	22.9	17.6	48.8	72.0
Internal Link Dist (m)		66.6			131.0			105.8		279.1
Turn Bay Length (m)			30.0			50.0	50.0		50.0	
Base Capacity (vph)		966	449	275	546	488	451	731	454	619
Starvation Cap Reductn		0	0	0	0	0	0	0	0	0
Spillback Cap Reductn		0	0	0	0	0	0	0	0	0
Storage Cap Reductn		0	0	0	0	0	0	0	0	0
Reduced v/c Ratio		0.35	0.13	0.02	0.18	0.12	0.34	0.15	0.47	0.55

Intersection Summary

Cycle Length: 95
 Actuated Cycle Length: 95
 Offset: 6 (6%), Referenced to phase 2:SBTL and 6:NBTL, Start of Green
 Natural Cycle: 95
 Control Type: Actuated-Coordinated
 Maximum v/c Ratio: 0.55
 Intersection Signal Delay: 20.5
 Intersection Capacity Utilization 98.0%
 Analysis Period (min) 15

Intersection LOS: C
 ICU Level of Service F

Splits and Phases: 3: Gottingen Street & Cogswell Street

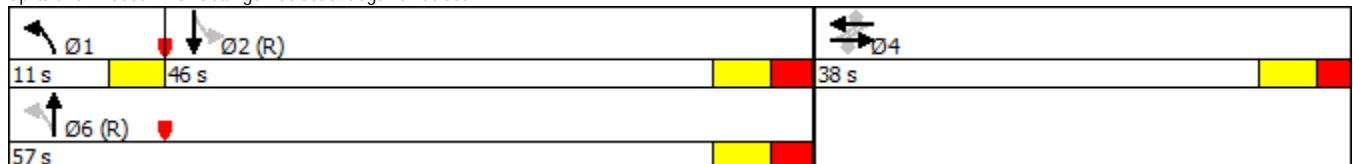

Halifax Transit Priority Corridors

1: Gottingen Street & North Street

Lane Group	EBL	EBT	WBL	WBT	WBR	NBT	NBR	SBL	SBT
Lane Configurations									
Traffic Volume (vph)	15	645	245	495	445	335	530	230	195
Future Volume (vph)	15	645	245	495	445	335	530	230	195
Lane Group Flow (vph)	0	733	266	538	484	364	576	250	234
Turn Type	Perm	NA	pm+pt	NA	Perm	NA	Perm	pm+pt	NA
Protected Phases		8	7	4		6		5	2
Permitted Phases	8		4		4		6	2	
Detector Phase	8	8	7	4	4	6	6	5	2
Switch Phase									
Minimum Initial (s)	10.0	10.0	7.0	10.0	10.0	10.0	10.0	7.0	10.0
Minimum Split (s)	27.0	27.0	10.0	41.0	41.0	39.0	39.0	10.0	49.0
Total Split (s)	27.0	27.0	14.0	41.0	41.0	39.0	39.0	10.0	49.0
Total Split (%)	30.0%	30.0%	15.6%	45.6%	45.6%	43.3%	43.3%	11.1%	54.4%
Yellow Time (s)	4.1	4.1	3.0	4.1	4.1	4.1	4.1	3.0	4.1
All-Red Time (s)	2.2	2.2	0.0	2.2	2.2	2.6	2.6	0.0	2.6
Lost Time Adjust (s)		0.0	0.0	0.0	0.0	0.0	0.0	0.0	0.0
Total Lost Time (s)		6.3	3.0	6.3	6.3	6.7	6.7	3.0	6.7
Lead/Lag	Lag	Lag	Lead			Lag	Lag	Lead	
Lead-Lag Optimize?									
Recall Mode	None	None	None	None	None	C-Min	C-Min	None	C-Min
Act Effect Green (s)		21.0	39.1	35.8	35.8	31.1	31.1	44.9	41.2
Actuated g/C Ratio		0.23	0.43	0.40	0.40	0.35	0.35	0.50	0.46
v/c Ratio		0.94	0.89	0.77	0.64	0.79	0.99	0.66	0.37
Control Delay		40.5	48.7	32.1	8.8	40.1	47.2	23.7	17.0
Queue Delay		44.9	0.0	0.0	0.0	0.0	7.3	0.0	0.0
Total Delay		85.4	48.7	32.1	8.8	40.1	54.5	23.7	17.0
LOS		F	D	C	A	D	D	C	B
Approach Delay		85.4		26.8		48.9			20.5
Approach LOS		F		C		D			C
Queue Length 50th (m)		52.7	31.3	82.0	13.5	54.6	45.0	23.8	23.8
Queue Length 95th (m)		#97.6	m#72.4	m#129.3	m41.7	#96.6	#119.9	39.2	40.9
Internal Link Dist (m)		72.5		71.6		338.9			95.8
Turn Bay Length (m)								60.0	
Base Capacity (vph)		782	300	695	757	480	593	376	654
Starvation Cap Reductn		0	0	0	0	0	0	0	0
Spillback Cap Reductn		144	0	0	0	0	20	0	0
Storage Cap Reductn		0	0	0	0	0	0	0	0
Reduced v/c Ratio		1.15	0.89	0.77	0.64	0.76	1.01	0.66	0.36

Intersection Summary





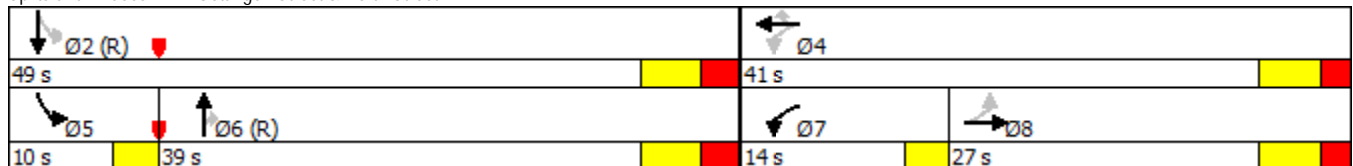









Cycle Length: 90
 Actuated Cycle Length: 90
 Offset: 17 (19%), Referenced to phase 2:SBTL and 6:NBT, Start of Green
 Natural Cycle: 90
 Control Type: Actuated-Coordinated
 Maximum v/c Ratio: 0.99
 Intersection Signal Delay: 44.4
 Intersection Capacity Utilization 106.5%
 Analysis Period (min) 15
 # 95th percentile volume exceeds capacity, queue may be longer.
 Queue shown is maximum after two cycles.
 m Volume for 95th percentile queue is metered by upstream signal.

Splits and Phases: 1: Gottingen Street & North Street



Halifax Transit Priority Corridors

2: Gottingen Street & Cornwallis Street

									
Lane Group	EBL2	EBT	WBL	WBT	NBL	NBT	NBR	SBL	SBT
Lane Configurations									
Traffic Volume (vph)	55	70	10	200	20	425	55	35	365
Future Volume (vph)	55	70	10	200	20	425	55	35	365
Lane Group Flow (vph)	0	156	0	311	0	494	72	0	495
Turn Type	Perm	NA	Perm	NA	Perm	NA	Perm	Perm	NA
Protected Phases		4		4		2			2
Permitted Phases	4		4		2		2	2	
Minimum Split (s)	29.0	29.0	29.0	29.0	28.0	28.0	28.0	28.0	28.0
Total Split (s)	35.0	35.0	35.0	35.0	55.0	55.0	55.0	55.0	55.0
Total Split (%)	38.9%	38.9%	38.9%	38.9%	61.1%	61.1%	61.1%	61.1%	61.1%
Yellow Time (s)	3.9	3.9	3.9	3.9	3.9	3.9	3.9	3.9	3.9
All-Red Time (s)	2.0	2.0	2.0	2.0	1.6	1.6	1.6	1.6	1.6
Lost Time Adjust (s)		0.0		0.0		0.0		0.0	0.0
Total Lost Time (s)		5.9		5.9		5.5		5.5	5.5
Lead/Lag									
Lead-Lag Optimize?									
Act Effct Green (s)		29.1		29.1		49.5		49.5	49.5
Actuated g/C Ratio		0.32		0.32		0.55		0.55	0.55
v/c Ratio		0.36		0.55		0.52		0.08	0.54
Control Delay		25.1		29.4		15.3		6.0	15.4
Queue Delay		0.0		0.0		0.0		0.0	0.8
Total Delay		25.1		29.4		15.3		6.0	16.2
LOS		C		C		B		A	B
Approach Delay		25.1		29.4		14.1			16.2
Approach LOS		C		C		B			B
Queue Length 50th (m)		19.5		43.8		50.4		2.8	50.2
Queue Length 95th (m)		35.8		69.1		76.6		8.6	77.0
Internal Link Dist (m)		136.3		95.8		282.9			129.1
Turn Bay Length (m)								85.0	
Base Capacity (vph)		436		569		949		867	919
Starvation Cap Reductn		0		0		0		0	183
Spillback Cap Reductn		0		0		0		0	0
Storage Cap Reductn		0		0		0		0	0
Reduced v/c Ratio		0.36		0.55		0.52		0.08	0.67

Intersection Summary

Cycle Length: 90
 Actuated Cycle Length: 90
 Offset: 0 (0%), Referenced to phase 2:NBSB, Start of Green
 Natural Cycle: 60
 Control Type: Pretimed
 Maximum v/c Ratio: 0.55
 Intersection Signal Delay: 19.0
 Intersection Capacity Utilization 88.7%
 Analysis Period (min) 15

Intersection LOS: B
 ICU Level of Service E

Splits and Phases: 2: Gottingen Street & Cornwallis Street

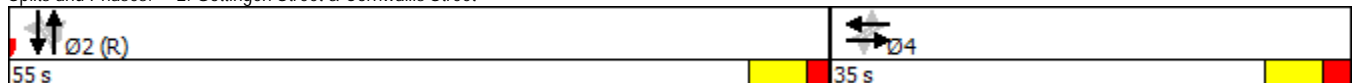

Halifax Transit Priority Corridors

3: Gottingen Street & Cogswell Street

Lane Group	EBL	EBT	EBR	WBL	WBT	WBR	NBL	NBT	SBL	SBT
Lane Configurations										
Traffic Volume (vph)	50	175	45	10	265	140	400	270	75	145
Future Volume (vph)	50	175	45	10	265	140	400	270	75	145
Lane Group Flow (vph)	0	258	52	11	305	161	460	327	86	236
Turn Type	Perm	NA	Perm	Perm	NA	Perm	pm+pt	NA	Perm	NA
Protected Phases		4			4		1	6		2
Permitted Phases	4		4	4		4	6		2	
Detector Phase	4	4		4	4		1	6	2	2
Switch Phase										
Minimum Initial (s)	7.0	7.0	7.0	7.0	7.0	7.0	7.0	7.0	7.0	7.0
Minimum Split (s)	36.7	36.7	36.7	36.7	36.7	36.7	11.0	44.2	44.2	44.2
Total Split (s)	38.0	38.0	38.0	38.0	38.0	38.0	16.0	62.0	46.0	46.0
Total Split (%)	38.0%	38.0%	38.0%	38.0%	38.0%	38.0%	16.0%	62.0%	46.0%	46.0%
Yellow Time (s)	4.1	4.1	4.1	4.1	4.1	4.1	4.0	4.1	4.1	4.1
All-Red Time (s)	2.6	2.6	2.6	2.6	2.6	2.6	0.0	3.1	3.1	3.1
Lost Time Adjust (s)		0.0	0.0	0.0	0.0	0.0	0.0	0.0	0.0	0.0
Total Lost Time (s)		6.7	6.7	6.7	6.7	6.7	4.0	7.2	7.2	7.2
Lead/Lag							Lead		Lag	Lag
Lead-Lag Optimize?										
Recall Mode	Max	Max	Max	Max	Max	Max	Max	C-Max	C-Max	C-Max
Act Effct Green (s)		31.3	31.3	31.3	31.3	31.3	58.0	54.8	38.8	38.8
Actuated g/C Ratio		0.31	0.31	0.31	0.31	0.31	0.58	0.55	0.39	0.39
v/c Ratio		0.35	0.12	0.04	0.59	0.33	0.79	0.43	0.25	0.39
Control Delay		28.2	2.2	24.6	34.5	6.2	25.9	15.3	23.2	22.0
Queue Delay		0.0	0.0	0.0	0.0	0.0	0.0	0.0	0.0	0.0
Total Delay		28.2	2.2	24.6	34.5	6.2	25.9	15.3	23.2	22.0
LOS		C	A	C	C	A	C	B	C	C
Approach Delay		23.9			24.7			21.5		22.3
Approach LOS		C			C			C		C
Queue Length 50th (m)		20.2	0.0	1.5	49.5	0.0	49.5	34.9	11.1	28.9
Queue Length 95th (m)		29.9	2.4	5.3	73.3	12.6	#72.5	52.5	21.9	46.5
Internal Link Dist (m)		66.6			100.9			105.8		282.9
Turn Bay Length (m)			30.0			50.0	50.0		50.0	
Base Capacity (vph)		731	442	288	518	490	579	765	347	609
Starvation Cap Reductn		0	0	0	0	0	0	0	0	0
Spillback Cap Reductn		0	0	0	0	0	0	0	0	0
Storage Cap Reductn		0	0	0	0	0	0	0	0	0
Reduced v/c Ratio		0.35	0.12	0.04	0.59	0.33	0.79	0.43	0.25	0.39

Intersection Summary

Cycle Length: 100
 Actuated Cycle Length: 100
 Offset: 17 (17%), Referenced to phase 2:SBTL and 6:NBTL, Start of Green
 Natural Cycle: 95
 Control Type: Actuated-Coordinated
 Maximum v/c Ratio: 0.79
 Intersection Signal Delay: 22.8
 Intersection Capacity Utilization 117.0%
 Analysis Period (min) 15
 # 95th percentile volume exceeds capacity, queue may be longer.
 Queue shown is maximum after two cycles.

Splits and Phases: 3: Gottingen Street & Cogswell Street

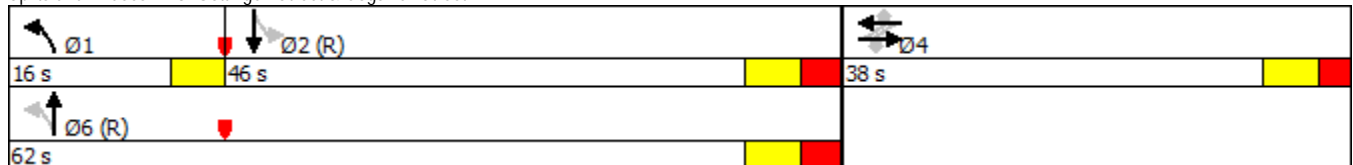

APPENDIX

G

BAYERS ROAD INTERSECTION CAPACITY ANALYSIS

Table G-1 - Bayers Road AM Peak Hour Intersection Analysis

Intersection		AM Peak Hour											
		Existing Conditions						Preferred Option					
		Scenario	Approach ¹	Delay	V/C	LOS	Queue	Option	Approach ¹	Delay	V/C	LOS	Queue
Bayers Road @	Romans	Existing (Page G-3)	EB-TR	41.4	1.01	D	277.6	High Invest ² (Page G-15)	EB-T	27.7	0.95	C	250.2
			EB-R	2.0	0.12	A	6.2		WB-T	4.9	0.42	A	25.1
			WB-TR	5.4	0.43	A	59.0		WB-R	0.2	0.02	A	0.0
			NB-L	40.9	0.29	D	24.1		NB-L	40.9	0.29	D	24.1
			NB-TR	36.4	0.21	D	23.9		NB-TR	38.1	0.21	D	24.5
				SB-LTR	29.2	0.33	C	28.0	SB-LTR	41.4	0.35	D	34.4
	HSC West	Existing (Page G-4)	EB-T	50.8	1.05	D	241.7	Medium Invest ³ (Page G-28)	EB-T	51.8	1.05	D	267.1
			EB-R	3.6	0.03	A	0.4		EB-R	3.4	0.03	A	0.4
			WB-T	2.8	0.46	A	9.3		WB-T	2.5	0.46	A	11.4
			NB-L	30.5	0.05	C	7.4		NB-L	30.5	0.05	C	7.4
	HSC East	Existing (Page G-5)	EB-TR	30.6	1.00	C	0.0	Medium Invest ³ (Page G-29)	EB-TR	27.7	1.00	C	0.0
			WB-L	28.5	0.29	C	31.3		WB-T	10.3	0.44	B	52.7
			WB-T	11.2	0.44	B	66.4		NB-R	22.6	0.23	C	19.4
			NB-R	29.0	0.24	C	22.6		SB-T	33.5	0.30	C	33.0
	Connaught	Existing (Page G-6)	EB-L	26.4	0.90	C	25.6	Medium Invest ⁴ (Page G-30)	EB-L	14.2	0.81	B	15.4
			EB-T	30.2	0.88	C	82.1		EB-T	29.9	0.88	C	86.4
			EB-R	56.6	0.99	E	196.8		EB-R	59.6	0.99	E	205.7
			WB-TR	28.0	0.60	C	78.8		WB-T	26.5	0.49	C	62.5
			NB-L	56.4	0.63	E	34.5		WB-R	3.6	0.21	A	4.5
			NB-TR	30.3	0.60	C	90.2		NB-L	52.3	0.52	D	28.7
			SB-T	36.4	0.28	D	28.3		NB-TR	32.6	0.66	C	102.2
			SB-R	24.1	0.28	C	32.2		SB-T	36.2	0.28	D	28.1
	Oxford	Existing (Page G-7)	EB-LT	2.7	0.50	A	14.2	High Invest ⁵ (Page G-17)	EB-LT	2.7	0.50	A	14.5
			EB-R	0.4	0.26	A	0.0		EB-R	0.4	0.26	A	0.0
			WB-LTR	3.3	0.18	A	12.6		WB-LT	6.2	0.30	A	40.8
			NB-L	64.0	0.68	E	36.9		WB-R	3.2	0.03	A	2.8
			NB-TR	47.9	0.59	D	41.7		NB-L	63.9	0.67	E	36.7
			SB-L	41.2	0.17	D	10.5		NB-TR	49.1	0.61	D	43.2
	Windsor	Existing (Page G-8)	SB-TR	50.8	0.54	D	36.0	High Invest ⁶ (Page G-18)	SB-L	42.0	0.19	D	11.2
			EB-L	10.8	0.12	B	7.6		SB-TR	51.4	0.53	D	36.2
			EB-T	28.1	0.83	C	158.1		EB-L	12.4	0.15	B	10.8
			EB-R	1.3	0.14	A	2.5		EB-T	27.1	0.79	C	147.3
			WB-L	16.9	0.28	B	15.0		EB-R	1.3	0.14	A	2.5
			WB-TR	13.4	0.21	B	22.7		WB-L	15.9	0.22	B	12.7
			NB-L	46.2	0.56	D	39.0		WB-T	19.3	0.34	B	52.3
			NB-T	34.8	0.42	C	54.5		WB-R	3.6	0.15	A	8.8
NB-R	6.5	0.32	A	14.8	NB-L	47.7	0.54	D	31.8				
			SB-L	23.7	0.32	C	31.5	NB-T	34.8	0.42	C	54.5	
			SB-TR	37.9	0.75	D	121.8	NB-R	6.4	0.32	A	15.0	
							SB-L	22.8	0.31	C	27.5		
							SB-TR	45.9	0.86	D	158.0		

- Notes:
1. Bayers Road is east/west for the full corridor
 2. Installation of eastbound and westbound right turn (except buses) lanes at Romans intersection.
 3. Realignment of HSC entering vehicles from westbound left to southbound through movement.
 4. Realignment of HSC entering traffic changes the traffic patterns at Connaught intersection; added westbound right turn lane (except buses).
 5. Reassignment of westbound through/right lane as right turn only (except buses) at Oxford intersection.
 6. Reassignment of westbound through/right lane as right turn only (except buses) and installation of eastbound right turn only lane (except buses) at Windsor intersection.

Table G-2 - Bayers Road PM Peak Hour Intersection Analysis

Intersection		PM Peak Hour												
		Existing Conditions						Preferred Option						
		Scenario	Approach ¹	Delay	V/C	LOS	Queue	Scenario	Approach ¹	Delay	V/C	LOS	Queue	
Bayers Road @	Romans	Existing (Page G-9)	EB-TR	18.3	0.80	B	171.9	High Invest ² (Page G-21)	EB-T	15.7	0.72	B	143.1	
			EB-R						EB-R	1.9	0.14	A	7.1	
			WB-TR	30.8	1.01	C	345.5		WB-T	27.5	1.00	C	314.0	
			NB-L	161.9	1.10	F	73.9		WB-R	1.2	0.03	A	0.0	
			NB-TR	40.0	0.25	D	33.1		NB-L	161.9	1.10	F	73.9	
		SB-LTR	92.5	0.97	F	134.5	NB-TR	43.4	0.26	D	34.8			
							SB-LTR	102.9	1.01	F	138.7			
		HSC West (Page G-10)	Existing	EB-T	20.8	0.59	C	130.6	Medium Invest ³ (Page G-34)	EB-T	16.7	0.55	B	124.8
	EB-R			8.8	0.10	A	11.8	EB-R		8.0	0.09	A	12.9	
	WB-T			9.5	0.94	A	20.1	WB-T		7.0	0.89	A	20.3	
	NB-L			48.3	0.58	D	64.4	NB-L		55.6	0.70	E	64.4	
		HSC East (Page G-11)	Existing	EB-TR	2.6	0.56	A	0.0	Medium Invest ³ (Page G-35)	EB-TR	2.4	0.53	A	0.0
	WB-L			46.4	0.32	D	27.8	WB-T		8.5	0.84	A	30.5	
	WB-T			34.8	0.89	C	38.1	NB-R		15.2	0.43	B	21.4	
	NB-R			14.1	0.37	B	21.4	SB-T		50.6	0.39	D	37.8	
		Connaught (Page G-12)	Existing	EB-L	124.4	1.07	F	96.0	Medium Invest ⁴ (Page G-36)	EB-L	109.2	1.03	F	89.9
	EB-T			39.5	0.80	D	122.8	EB-T		36.0	0.79	D	117.9	
	EB-R			9.6	0.68	A	32.0	EB-R		9.8	0.68	A	31.4	
	WB-TR			105.0	1.10	F	186.6	WB-T		93.7	0.99	F	158.0	
	NB-L			88.0	1.03	F	153.8	WB-R		3.2	0.20	A	6.0	
	NB-TR			17.9	0.24	B	38.9	NB-L		76.6	0.99	E	142.8	
	SB-T			45.4	0.23	D	24.8	NB-TR		19.1	0.28	B	48.2	
	SB-R			37.0	0.45	D	48.2	SB-T		45.6	0.23	D	25.1	
		Oxford (Page G-13)	Existing	EB-LT	12.0	0.45	B	71.4	High Invest ⁵ (Page G-23)	EB-LT	12.0	0.45	B	71.1
	EB-R			2.7	0.11	A	6.0	EB-R		2.7	0.11	A	6.0	
	WB-LTR			7.9	0.48	A	40.9	WB-LT		11.9	0.66	B	82.6	
	NB-L			40.7	0.55	D	37.7	WB-R		1.5	0.20	A	4.8	
	NB-TR			47.8	0.77	D	70.0	NB-L		41.2	0.56	D	37.9	
	SB-L			30.4	0.16	C	8.6	NB-TR		47.8	0.77	D	70.0	
	SB-TR			27.6	0.19	C	17.2	SB-L		30.4	0.16	C	8.6	
		Windsor (Page G-14)	Existing	EB-L	30.0	0.44	C	20.8	High Invest ⁶ (Page G-24)	EB-L	27.1	0.37	C	20.5
	EB-TR			58.0	0.95	E	145.7	EB-T		42.3	0.83	D	122.0	
	WB-L			32.8	0.66	C	32.3	EB-R		0.7	0.10	A	0.4	
	WB-TR			19.1	0.45	B	50.9	WB-L		26.0	0.56	C	28.6	
	NB-L			18.0	0.29	B	24.9	WB-T		27.1	0.62	C	95.8	
	NB-T			28.5	0.67	C	106.0	WB-R		3.8	0.23	A	11.0	
NB-R	3.9			0.21	A	10.6	NB-L	18.5		0.32	B	24.9		
SB-L	29.2			0.27	C	20.0	NB-T	28.5		0.67	C	106.0		
SB-TR	29.2	0.39	C	48.7	NB-R	3.9	0.21	A	10.6					
						SB-L	29.2	0.27	C	20.0				
						SB-TR	30.2	0.50	C	59.9				

- Notes:
1. Bayers Road is east/west for the full corridor
 2. Installation of eastbound and westbound right turn (except buses) lanes at Romans intersection.
 3. Realignment of HSC entering vehicles from westbound left to southbound through movement.
 4. Realignment of HSC entering traffic changes the traffic patterns at Connaught intersection; added westbound right turn lane (except buses).
 5. Reassignment of westbound through/right lane as right turn only (except buses) at Oxford intersection.
 6. Reassignment of westbound through/right lane as right turn only (except buses) and installation of eastbound right turn only lane (except buses) at Windsor intersection.

Lane Group	EBL	EBT	EBR	WBL	WBT	WBR	NBL	NBT	NBR	SBL	SBT	SBR
Lane Configurations												
Traffic Volume (vph)	5	1785	85	0	850	5	60	60	5	20	35	40
Future Volume (vph)	5	1785	85	0	850	5	60	60	5	20	35	40
Satd. Flow (prot)	0	2996	0	0	3096	0	1498	1544	0	0	1479	0
Flt Permitted		0.953					0.696				0.932	
Satd. Flow (perm)	0	2855	0	0	3096	0	1045	1544	0	0	1358	0
Satd. Flow (RTOR)		9			1			3			30	
Lane Group Flow (vph)	0	1973	0	0	900	0	63	68	0	0	100	0
Turn Type	Perm	NA			NA		Perm	NA		Perm	NA	
Protected Phases		2			2			4			4	
Permitted Phases	2						4			4		
Total Split (s)	80.0	80.0			80.0		30.0	30.0		30.0	30.0	
Total Lost Time (s)		5.8			5.8		6.1	6.1			6.1	
Act Effct Green (s)		75.1			75.1		23.0	23.0			23.0	
Actuated g/C Ratio		0.68			0.68		0.21	0.21			0.21	
v/c Ratio		1.01			0.43		0.29	0.21			0.33	
Control Delay		41.4			5.4		40.9	36.4			29.2	
Queue Delay		0.0			0.0		0.0	0.0			0.0	
Total Delay		41.4			5.4		40.9	36.4			29.2	
LOS		D			A		D	D			C	
Approach Delay		41.4			5.4			38.6			29.2	
Approach LOS		D			A			D			C	
Queue Length 50th (m)		-212.5			13.1		11.5	11.6			12.6	
Queue Length 95th (m)		#277.6			59.0		24.1	23.9			28.0	
Internal Link Dist (m)		76.6			386.3			826.4			535.1	
Turn Bay Length (m)							40.0					
Base Capacity (vph)		1952			2114		227	337			318	
Starvation Cap Reductn		0			0		0	0			0	
Spillback Cap Reductn		0			0		0	0			0	
Storage Cap Reductn		0			0		0	0			0	
Reduced v/c Ratio		1.01			0.43		0.28	0.20			0.31	

Intersection Summary

Cycle Length: 110
 Actuated Cycle Length: 110
 Offset: 8 (7%), Referenced to phase 2:EBWB and 6:, Start of Green
 Control Type: Actuated-Coordinated
 Maximum v/c Ratio: 1.01
 Intersection Signal Delay: 30.4
 Intersection Capacity Utilization 91.3%
 Analysis Period (min) 15
 ~ Volume exceeds capacity, queue is theoretically infinite.
 Queue shown is maximum after two cycles.
 # 95th percentile volume exceeds capacity, queue may be longer.
 Queue shown is maximum after two cycles.

Splits and Phases: 1: Romans & Bayers

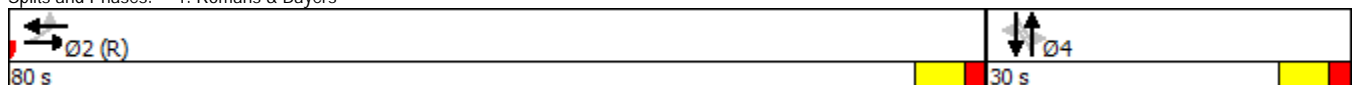

	→	↘	↙	←	↖	↗	Ø4
Lane Group	EBT	EBR	WBL	WBT	NBL	NBR	
Lane Configurations	↑↑	↗		↑↑	↘↗		
Traffic Volume (vph)	1800	25	0	795	35	0	
Future Volume (vph)	1800	25	0	795	35	0	
Satd. Flow (prot)	3131	1401	0	3131	3038	0	
Fit Permitted					0.950		
Satd. Flow (perm)	3131	1401	0	3131	3038	0	
Satd. Flow (RTOR)		10					
Lane Group Flow (vph)	2000	28	0	883	39	0	
Turn Type	NA	Perm		NA	Prot		
Protected Phases	2			6	8		4
Permitted Phases		2					
Total Split (s)	75.0	75.0		75.0	35.0		35.0
Total Lost Time (s)	7.9	7.9		7.9	6.0		
Act Effct Green (s)	67.1	67.1		67.1	29.0		
Actuated g/C Ratio	0.61	0.61		0.61	0.26		
v/c Ratio	1.05	0.03		0.46	0.05		
Control Delay	39.0	3.6		2.7	30.5		
Queue Delay	11.8	0.0		0.1	0.0		
Total Delay	50.8	3.6		2.8	30.5		
LOS	D	A		A	C		
Approach Delay	50.1			2.8	30.5		
Approach LOS	D			A	C		
Queue Length 50th (m)	~243.0	0.3		5.1	3.2		
Queue Length 95th (m)	m#241.7	m0.4		9.3	7.4		
Internal Link Dist (m)	386.3			15.6	295.6		
Turn Bay Length (m)		25.0					
Base Capacity (vph)	1909	858		1909	800		
Starvation Cap Reductn	0	0		204	0		
Spillback Cap Reductn	52	0		0	0		
Storage Cap Reductn	0	0		0	0		
Reduced v/c Ratio	1.08	0.03		0.52	0.05		

Intersection Summary

Cycle Length: 110
 Actuated Cycle Length: 110
 Offset: 34 (31%), Referenced to phase 2:EBT and 6:WBT, Start of Green
 Control Type: Actuated-Coordinated
 Maximum v/c Ratio: 1.05
 Intersection Signal Delay: 35.7
 Intersection Capacity Utilization 73.0%
 Analysis Period (min) 15
 ~ Volume exceeds capacity, queue is theoretically infinite.
 Queue shown is maximum after two cycles.
 # 95th percentile volume exceeds capacity, queue may be longer.
 Queue shown is maximum after two cycles.
 m Volume for 95th percentile queue is metered by upstream signal.

Splits and Phases: 2: HSC W & Bayers

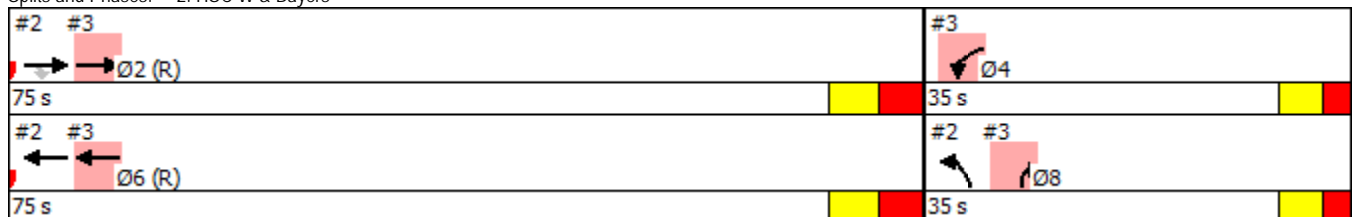

Lane Group	EBT	EBR	WBL	WBT	NBL	NBR
Lane Configurations						
Traffic Volume (vph)	1775	25	220	795	0	150
Future Volume (vph)	1775	25	220	795	0	150
Satd. Flow (prot)	3088	0	3008	3101	0	2442
Flt Permitted			0.950			
Satd. Flow (perm)	3088	0	3008	3101	0	2442
Satd. Flow (RTOR)	2					19
Lane Group Flow (vph)	1875	0	229	828	0	156
Turn Type	NA		Prot	NA		Prot
Protected Phases	2		4	6		8
Permitted Phases						
Total Split (s)	75.0		35.0	75.0		35.0
Total Lost Time (s)	7.9		6.0	7.9		6.0
Act Effct Green (s)	67.1		29.0	67.1		29.0
Actuated g/C Ratio	0.61		0.26	0.61		0.26
v/c Ratio	1.00		0.29	0.44		0.24
Control Delay	9.5		28.5	10.9		29.0
Queue Delay	21.0		0.0	0.3		0.0
Total Delay	30.6		28.5	11.2		29.0
LOS	C		C	B		C
Approach Delay	30.6			14.9	29.0	
Approach LOS	C			B	C	
Queue Length 50th (m)	0.0		19.8	47.0		13.0
Queue Length 95th (m)	m0.0		31.3	66.4		22.6
Internal Link Dist (m)	15.6			119.7	310.7	
Turn Bay Length (m)			45.0			
Base Capacity (vph)	1884		793	1891		657
Starvation Cap Reductn	85		0	441		0
Spillback Cap Reductn	114		0	0		0
Storage Cap Reductn	0		0	0		0
Reduced v/c Ratio	1.06		0.29	0.57		0.24

Intersection Summary

Cycle Length: 110
 Actuated Cycle Length: 110
 Offset: 34 (31%), Referenced to phase 2:EBT and 6:WBT, Start of Green
 Control Type: Actuated-Coordinated
 Maximum v/c Ratio: 1.05
 Intersection Signal Delay: 25.1
 Intersection Capacity Utilization 74.4%
 Analysis Period (min) 15
 m Volume for 95th percentile queue is metered by upstream signal.

Intersection LOS: C
ICU Level of Service D

Splits and Phases: 3: HSC E & Bayers

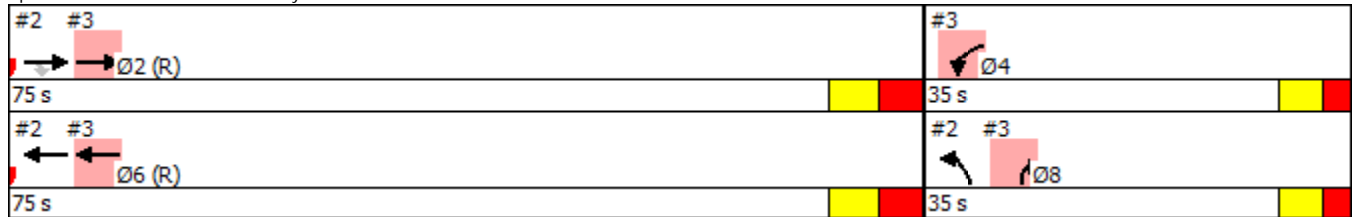

Halifax Transit Priority Corridors

4: Connaught & Bayers

Lane Group	EBL	EBT	EBR	WBL	WBT	WBR	NBL	NBT	NBR	SBL	SBT	SBR
Lane Configurations												
Traffic Volume (vph)	325	700	900	0	565	25	200	265	90	0	185	250
Future Volume (vph)	325	700	900	0	565	25	200	265	90	0	185	250
Satd. Flow (prot)	1551	1632	1387	0	2937	0	3008	1541	0	0	3039	2393
Fit Permitted	0.281						0.950					
Satd. Flow (perm)	455	1632	1326	0	2937	0	3008	1541	0	0	3039	2393
Satd. Flow (RTOR)			567		4			19				
Lane Group Flow (vph)	339	729	938	0	615	0	208	370	0	0	193	260
Turn Type	pm+pt	NA	Perm		NA		Prot	NA			NA	pt+ov
Protected Phases	5	2			6		3	8			4	4 5
Permitted Phases	2		2									
Total Split (s)	17.0	61.0	61.0		44.0		18.0	49.0			31.0	
Total Lost Time (s)	4.0	5.9	5.9		5.9		6.0	5.2			5.2	
Act Effct Green (s)	57.8	55.9	55.9		38.1		12.0	43.0			25.0	42.8
Actuated g/C Ratio	0.53	0.51	0.51		0.35		0.11	0.39			0.23	0.39
v/c Ratio	0.90	0.88	0.99		0.60		0.63	0.60			0.28	0.28
Control Delay	26.4	16.0	24.7		28.0		56.4	30.3			36.4	24.1
Queue Delay	0.0	14.2	31.9		0.0		0.0	0.0			0.0	0.0
Total Delay	26.4	30.2	56.6		28.0		56.4	30.3			36.4	24.1
LOS	C	C	E		C		E	C			D	C
Approach Delay		41.9			28.0			39.7			29.3	
Approach LOS		D			C			D			C	
Queue Length 50th (m)	22.3	76.4	198.7		48.7		22.3	59.1			18.1	21.4
Queue Length 95th (m)	m25.6	m82.1	m#196.8		78.8		34.5	90.2			28.3	32.2
Internal Link Dist (m)		119.7			440.1			461.8			84.0	
Turn Bay Length (m)	90.0						110.0					35.0
Base Capacity (vph)	376	829	952		1019		328	625			712	835
Starvation Cap Reductn	0	101	87		0		0	0			0	0
Spillback Cap Reductn	0	0	0		0		0	0			0	0
Storage Cap Reductn	0	0	0		0		0	0			0	0
Reduced v/c Ratio	0.90	1.00	1.08		0.60		0.63	0.59			0.27	0.31

Intersection Summary

Cycle Length: 110

Actuated Cycle Length: 110

Offset: 70 (64%), Referenced to phase 2:EBTL and 6:WBT, Start of Green

Control Type: Actuated-Coordinated

Maximum v/c Ratio: 0.99

Intersection Signal Delay: 37.6

Intersection LOS: D

Intersection Capacity Utilization 94.7%

ICU Level of Service F

Analysis Period (min) 15

95th percentile volume exceeds capacity, queue may be longer.

Queue shown is maximum after two cycles.

m Volume for 95th percentile queue is metered by upstream signal.

Splits and Phases: 4: Connaught & Bayers



Lane Group	EBL	EBT	EBR	WBL	WBT	WBR	NBL	NBT	NBR	SBL	SBT	SBR
Lane Configurations												
Traffic Volume (vph)	0	500	205	20	305	30	100	100	35	20	100	5
Future Volume (vph)	0	500	205	20	305	30	100	100	35	20	100	5
Satd. Flow (prot)	0	1419	1085	0	2942	0	1449	1485	0	1420	1334	0
Fit Permitted					0.913		0.682			0.588		
Satd. Flow (perm)	0	1419	1033	0	2692	0	1024	1485	0	802	1334	0
Satd. Flow (RTOR)			214		18			15			2	
Lane Group Flow (vph)	0	521	214	0	370	0	104	140	0	21	109	0
Turn Type		NA	Perm	Perm	NA		Perm	NA		Perm	NA	
Protected Phases		2			6			8			4	
Permitted Phases	2		2	6			8			4		
Total Split (s)	78.0	78.0	78.0	78.0	78.0		32.0	32.0		32.0	32.0	
Total Lost Time (s)		5.9	5.9		5.9		5.9	5.9		5.9	5.9	
Act Effct Green (s)		81.6	81.6		81.6		16.6	16.6		16.6	16.6	
Actuated g/C Ratio		0.74	0.74		0.74		0.15	0.15		0.15	0.15	
v/c Ratio		0.50	0.26		0.18		0.68	0.59		0.17	0.54	
Control Delay		2.7	0.4		3.3		64.0	47.9		41.2	50.8	
Queue Delay		0.0	0.0		0.0		0.0	0.0		0.0	0.0	
Total Delay		2.7	0.4		3.3		64.0	47.9		41.2	50.8	
LOS		A	A		A		E	D		D	D	
Approach Delay		2.0			3.3			54.8			49.3	
Approach LOS		A			A			D			D	
Queue Length 50th (m)		10.9	0.0		6.6		21.4	25.3		4.0	21.5	
Queue Length 95th (m)		m14.2	m0.0		12.6		36.9	41.7		10.5	36.0	
Internal Link Dist (m)		440.1			309.1			518.4			229.7	
Turn Bay Length (m)			60.0				65.0			60.0		
Base Capacity (vph)		1051	821		2000		242	363		190	318	
Starvation Cap Reductn		0	0		0		0	0		0	0	
Spillback Cap Reductn		0	0		0		0	0		0	0	
Storage Cap Reductn		0	0		0		0	0		0	0	
Reduced v/c Ratio		0.50	0.26		0.18		0.43	0.39		0.11	0.34	

Intersection Summary

Cycle Length: 110
 Actuated Cycle Length: 110
 Offset: 76 (69%), Referenced to phase 2:EBTL and 6:WBTL, Start of Green
 Control Type: Actuated-Coordinated
 Maximum v/c Ratio: 0.68
 Intersection Signal Delay: 15.2
 Intersection Capacity Utilization 57.8%
 Analysis Period (min) 15
 m Volume for 95th percentile queue is metered by upstream signal.

Intersection LOS: B
ICU Level of Service B

Splits and Phases: 5: Oxford & Bayers

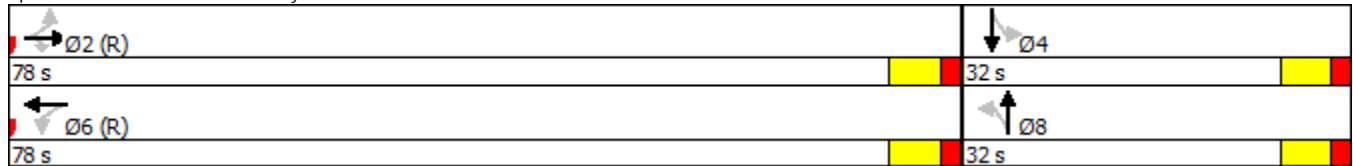

Halifax Transit Priority Corridors

6: Windsor & Bayers/Young

Lane Group	EBL	EBT	EBR	WBL	WBT	WBR	NBL	NBT	NBR	SBL	SBT	SBR
Lane Configurations												
Traffic Volume (vph)	40	395	80	65	205	70	100	180	150	125	420	0
Future Volume (vph)	40	395	80	65	205	70	100	180	150	125	420	0
Satd. Flow (prot)	1451	1523	0	1422	2899	0	1458	1607	1382	1473	1550	0
Fit Permitted	0.572			0.241			0.432			0.522		
Satd. Flow (perm)	873	1523	0	361	2899	0	663	1607	1350	803	1550	0
Satd. Flow (RTOR)		11		59					161			
Lane Group Flow (vph)	43	511	0	70	295	0	108	194	161	134	452	0
Turn Type	Perm	NA		pm+pt	NA		Perm	NA	Perm	pm+pt	NA	
Protected Phases		2		1	6			8		7	4	
Permitted Phases	2			6			8		8	4		
Total Split (s)	49.0	49.0		11.0	60.0		39.0	39.0	39.0	11.0	50.0	
Total Lost Time (s)	7.1	7.1		4.0	7.0		7.0	7.0	7.0	4.0	7.0	
Act Effct Green (s)	44.1	44.1		56.0	53.0		32.0	32.0	32.0	46.0	43.0	
Actuated g/C Ratio	0.40	0.40		0.51	0.48		0.29	0.29	0.29	0.42	0.39	
v/c Ratio	0.12	0.83		0.28	0.21		0.56	0.42	0.32	0.35	0.75	
Control Delay	10.8	28.1		16.9	13.4		46.2	34.8	6.5	23.7	37.9	
Queue Delay	0.0	0.0		0.0	0.0		0.0	0.0	0.0	0.0	0.0	
Total Delay	10.8	28.1		16.9	13.4		46.2	34.8	6.5	23.7	37.9	
LOS	B	C		B	B		D	C	A	C	D	
Approach Delay		26.8			14.1			27.6			34.7	
Approach LOS		C			B			C			C	
Queue Length 50th (m)	3.6	92.8		7.5	14.5		19.6	33.6	0.0	18.1	82.2	
Queue Length 95th (m)	m7.6	#158.1		15.0	22.7		39.0	54.5	14.8	31.5	121.8	
Internal Link Dist (m)		309.1			142.1			569.0			312.0	
Turn Bay Length (m)	50.0			40.0			90.0		50.0	40.0		
Base Capacity (vph)	349	616		251	1427		192	467	506	378	605	
Starvation Cap Reductn	0	0		0	0		0	0	0	0	0	
Spillback Cap Reductn	0	0		0	0		0	0	0	0	0	
Storage Cap Reductn	0	0		0	0		0	0	0	0	0	
Reduced v/c Ratio	0.12	0.83		0.28	0.21		0.56	0.42	0.32	0.35	0.75	

Intersection Summary

Cycle Length: 110
 Actuated Cycle Length: 110
 Offset: 14 (13%), Referenced to phase 2:EBTL and 6:WBTL, Start of Green
 Control Type: Actuated-Coordinated
 Maximum v/c Ratio: 0.83
 Intersection Signal Delay: 27.0
 Intersection Capacity Utilization 88.5%
 Analysis Period (min) 15
 # 95th percentile volume exceeds capacity, queue may be longer.
 Queue shown is maximum after two cycles.
 m Volume for 95th percentile queue is metered by upstream signal.

Intersection LOS: C
 ICU Level of Service E

Splits and Phases: 6: Windsor & Bayers/Young

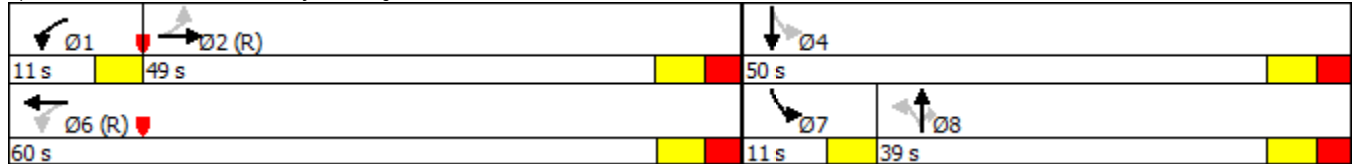

Halifax Transit Priority Corridors

1: Romans & Bayers

Lane Group	EBL	EBT	EBR	WBL	WBT	WBR	NBL	NBT	NBR	SBL	SBT	SBR
Lane Configurations												
Traffic Volume (vph)	0	1495	115	0	2125	5	120	75	15	5	30	270
Future Volume (vph)	0	1495	115	0	2125	5	120	75	15	5	30	270
Satd. Flow (prot)	0	3002	0	0	3130	0	1513	1531	0	0	1340	0
Fit Permitted							0.311				0.996	
Satd. Flow (perm)	0	3002	0	0	3130	0	480	1531	0	0	1334	0
Satd. Flow (RTOR)		14					7				12	
Lane Group Flow (vph)	0	1626	0	0	2151	0	121	91	0	0	308	0
Turn Type		NA			NA		Perm	NA		Perm	NA	
Protected Phases		2			2			4			4	
Permitted Phases							4			4		
Total Split (s)		94.0			94.0		36.0	36.0		36.0	36.0	
Total Lost Time (s)		5.8			5.8		6.1	6.1		6.1	6.1	
Act Effct Green (s)		88.2			88.2		29.9	29.9		29.9	29.9	
Actuated g/C Ratio		0.68			0.68		0.23	0.23		0.23	0.23	
v/c Ratio		0.80			1.01		1.10	0.25		0.97	0.97	
Control Delay		18.3			30.8		161.9	40.0		92.5	92.5	
Queue Delay		0.0			0.0		0.0	0.0		0.0	0.0	
Total Delay		18.3			30.8		161.9	40.0		92.5	92.5	
LOS		B			C		F	D		F	F	
Approach Delay		18.3			30.8			109.6		92.5	92.5	
Approach LOS		B			C			F		F	F	
Queue Length 50th (m)		139.6			~307.9		~35.0	17.7		76.3	76.3	
Queue Length 95th (m)		171.9			m#345.5		#73.9	33.1		#134.5	#134.5	
Internal Link Dist (m)		1417.0			385.8			886.2		555.5	555.5	
Turn Bay Length (m)							40.0					
Base Capacity (vph)		2041			2123		110	357		316	316	
Starvation Cap Reductn		0			0		0	0		0	0	
Spillback Cap Reductn		0			0		0	0		0	0	
Storage Cap Reductn		0			0		0	0		0	0	
Reduced v/c Ratio		0.80			1.01		1.10	0.25		0.97	0.97	

Intersection Summary

Cycle Length: 130
 Actuated Cycle Length: 130
 Offset: 57 (44%), Referenced to phase 2:EBWB and 6:, Start of Green
 Control Type: Actuated-Coordinated
 Maximum v/c Ratio: 1.10
 Intersection Signal Delay: 34.4
 Intersection Capacity Utilization 123.9%
 Analysis Period (min) 15
 ~ Volume exceeds capacity, queue is theoretically infinite.
 Queue shown is maximum after two cycles.
 # 95th percentile volume exceeds capacity, queue may be longer.
 Queue shown is maximum after two cycles.
 m Volume for 95th percentile queue is metered by upstream signal.

Splits and Phases: 1: Romans & Bayers



							Ø1
Lane Group	EBT	EBR	WBL	WBT	NBL	NBR	
Lane Configurations							
Traffic Volume (vph)	1095	85	0	1760	365	0	
Future Volume (vph)	1095	85	0	1760	365	0	
Satd. Flow (prot)	3131	1401	0	3131	3038	0	
Fit Permitted					0.950		
Satd. Flow (perm)	3131	1401	0	3131	3038	0	
Satd. Flow (RTOR)		52					
Lane Group Flow (vph)	1217	94	0	1956	406	0	
Turn Type	NA	Perm		NA	Prot		
Protected Phases	2			6	8		1
Permitted Phases		2					
Total Split (s)	94.0	94.0		94.0	36.0		36.0
Total Lost Time (s)	7.9	7.9		7.9	6.0		
Act Effct Green (s)	86.1	86.1		86.1	30.0		
Actuated g/C Ratio	0.66	0.66		0.66	0.23		
v/c Ratio	0.59	0.10		0.94	0.58		
Control Delay	20.8	8.8		9.5	48.3		
Queue Delay	0.0	0.0		0.3	0.0		
Total Delay	20.8	8.8		9.9	48.3		
LOS	C	A		A	D		
Approach Delay	19.9			9.9	48.3		
Approach LOS	B			A	D		
Queue Length 50th (m)	106.3	7.1		14.3	47.9		
Queue Length 95th (m)	130.6	m11.8		#20.1	64.4		
Internal Link Dist (m)	385.8			14.6	462.4		
Turn Bay Length (m)		25.0					
Base Capacity (vph)	2073	945		2073	701		
Starvation Cap Reductn	0	0		12	0		
Spillback Cap Reductn	0	0		0	0		
Storage Cap Reductn	0	0		0	0		
Reduced v/c Ratio	0.59	0.10		0.95	0.58		

Intersection Summary

Cycle Length: 130
 Actuated Cycle Length: 130
 Offset: 28 (22%), Referenced to phase 2:EBT and 6:WBT, Start of Green
 Control Type: Actuated-Coordinated
 Maximum v/c Ratio: 0.94
 Intersection Signal Delay: 17.7
 Intersection Capacity Utilization 77.6%
 Analysis Period (min) 15
 # 95th percentile volume exceeds capacity, queue may be longer.
 Queue shown is maximum after two cycles.
 m Volume for 95th percentile queue is metered by upstream signal.

Splits and Phases: 2: HSC W & Bayers

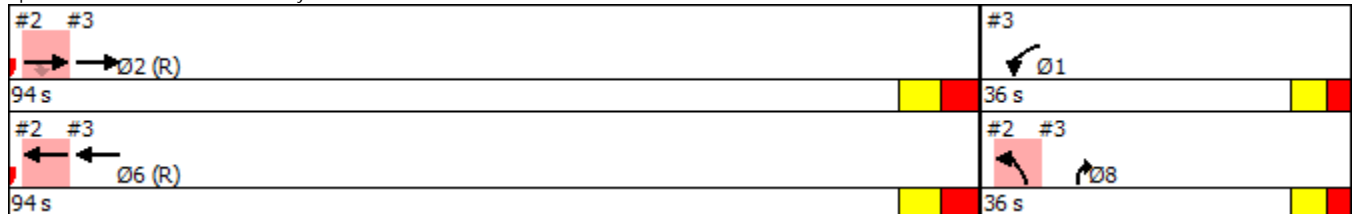

	→	↘	↙	←	↖	↗
Lane Group	EBT	EBR	WBL	WBT	NBL	NBR
Lane Configurations	↑↑		↘↙	↑↑		↗↖
Traffic Volume (vph)	1030	65	210	1760	0	255
Future Volume (vph)	1030	65	210	1760	0	255
Satd. Flow (prot)	3057	0	3008	3101	0	2442
Fit Permitted			0.950			
Satd. Flow (perm)	3057	0	3008	3101	0	2442
Satd. Flow (RTOR)	10					192
Lane Group Flow (vph)	1141	0	219	1833	0	266
Turn Type	NA		Prot	NA		Prot
Protected Phases	2		1	6		8
Permitted Phases						
Total Split (s)	94.0		36.0	94.0		36.0
Total Lost Time (s)	7.9		6.0	7.9		6.0
Act Effct Green (s)	86.1		30.0	86.1		30.0
Actuated g/C Ratio	0.66		0.23	0.66		0.23
v/c Ratio	0.56		0.32	0.89		0.37
Control Delay	2.6		46.4	8.3		14.0
Queue Delay	0.1		0.0	26.5		0.1
Total Delay	2.6		46.4	34.8		14.1
LOS	A		D	C		B
Approach Delay	2.6			36.0	14.1	
Approach LOS	A			D	B	
Queue Length 50th (m)	0.0		27.9	39.7		8.6
Queue Length 95th (m)	0.0		m27.8	m38.1		21.4
Internal Link Dist (m)	14.6			119.7	460.0	
Turn Bay Length (m)			45.0			
Base Capacity (vph)	2028		694	2053		711
Starvation Cap Reductn	87		0	311		0
Spillback Cap Reductn	23		0	9		72
Storage Cap Reductn	0		0	0		0
Reduced v/c Ratio	0.59		0.32	1.05		0.42

Intersection Summary

Cycle Length: 130
 Actuated Cycle Length: 130
 Offset: 28 (22%), Referenced to phase 2:EBT and 6:WBT, Start of Green
 Control Type: Actuated-Coordinated
 Maximum v/c Ratio: 0.94
 Intersection Signal Delay: 23.3
 Intersection Capacity Utilization 61.0%
 Analysis Period (min) 15
 m Volume for 95th percentile queue is metered by upstream signal.

Intersection LOS: C
ICU Level of Service B

Splits and Phases: 3: HSC E & Bayers

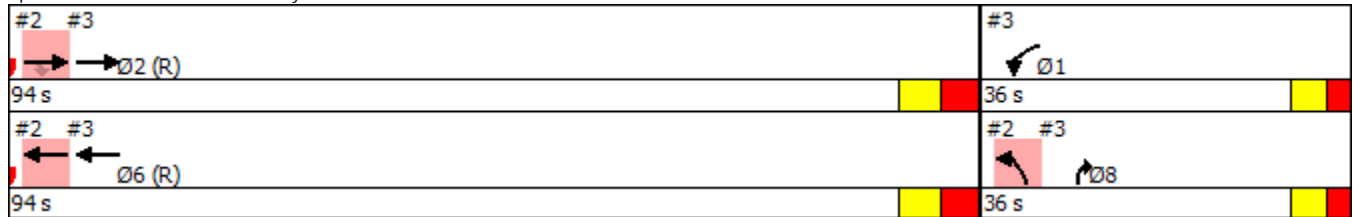

Lane Group	EBL	EBT	EBR	WBL	WBT	WBR	NBL	NBT	NBR	SBL	SBT	SBR
Lane Configurations												
Traffic Volume (vph)	195	515	575	0	900	10	780	145	35	0	130	290
Future Volume (vph)	195	515	575	0	900	10	780	145	35	0	130	290
Satd. Flow (prot)	1551	1632	1387	0	2939	0	3008	1562	0	0	3039	2393
Fit Permitted	0.095						0.950					
Satd. Flow (perm)	154	1632	1318	0	2939	0	2927	1562	0	0	3039	2269
Satd. Flow (RTOR)			575		1			13				
Lane Group Flow (vph)	203	536	599	0	948	0	813	187	0	0	135	302
Turn Type	pm+pt	NA	Perm		NA		Prot	NA			NA	pm+ov
Protected Phases	5	2			6		3	8			4	5
Permitted Phases	2		2									4
Total Split (s)	15.0	59.0	59.0		44.0		40.0	71.0			31.0	15.0
Total Lost Time (s)	4.0	5.9	5.9		5.9		6.0	5.2			5.2	4.0
Act Effct Green (s)	55.6	53.7	53.7		38.1		34.0	65.2			25.2	38.0
Actuated g/C Ratio	0.43	0.41	0.41		0.29		0.26	0.50			0.19	0.29
v/c Ratio	1.07	0.80	0.68		1.10		1.03	0.24			0.23	0.45
Control Delay	124.4	36.7	9.4		104.5		88.0	17.9			45.4	37.0
Queue Delay	0.0	2.7	0.2		0.5		0.0	0.0			0.0	0.0
Total Delay	124.4	39.5	9.6		105.0		88.0	17.9			45.4	37.0
LOS	F	D	A		F		F	B			D	D
Approach Delay		39.0			105.0			74.9			39.6	
Approach LOS		D			F			E			D	
Queue Length 50th (m)	-47.7	83.2	20.9		-145.1		-115.1	24.5			15.5	34.0
Queue Length 95th (m)	#96.0	122.8	32.0		#186.6		#153.8	38.9			24.8	48.2
Internal Link Dist (m)		119.7			440.1			1920.3			104.0	
Turn Bay Length (m)	90.0						110.0					35.0
Base Capacity (vph)	190	674	882		862		786	797			603	685
Starvation Cap Reductn	0	63	31		0		0	0			0	0
Spillback Cap Reductn	0	0	0		67		0	0			0	0
Storage Cap Reductn	0	0	0		0		0	0			0	0
Reduced v/c Ratio	1.07	0.88	0.70		1.19		1.03	0.23			0.22	0.44

Intersection Summary

Cycle Length: 130
 Actuated Cycle Length: 130
 Offset: 26 (20%), Referenced to phase 2:EBTL and 6:WBT, Start of Green
 Control Type: Actuated-Coordinated
 Maximum v/c Ratio: 1.10
 Intersection Signal Delay: 65.5
 Intersection Capacity Utilization 103.9%
 Analysis Period (min) 15
 Intersection LOS: E
 ICU Level of Service G

~ Volume exceeds capacity, queue is theoretically infinite.
 Queue shown is maximum after two cycles.
 # 95th percentile volume exceeds capacity, queue may be longer.
 Queue shown is maximum after two cycles.

Splits and Phases: 4: Connaught & Bayers

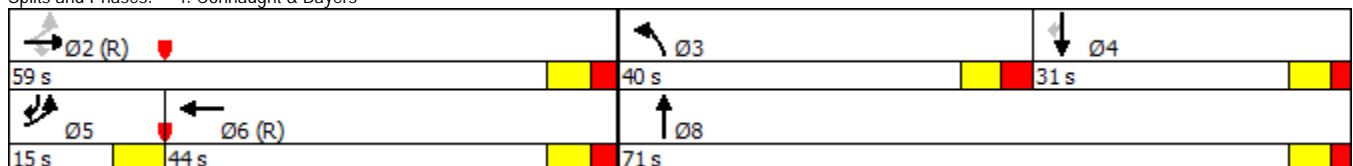

Halifax Transit Priority Corridors

5: Oxford & Bayers

Lane Group	EBL	EBT	EBR	WBL	WBT	WBR	NBL	NBT	NBR	SBL	SBT	SBR
Lane Configurations												
Traffic Volume (vph)	10	395	75	20	640	185	135	240	40	20	55	5
Future Volume (vph)	10	395	75	20	640	185	135	240	40	20	55	5
Satd. Flow (prot)	0	1429	1094	0	2874	0	1449	1548	0	1420	1325	0
Fit Permitted		0.977			0.940		0.717			0.376		
Satd. Flow (perm)	0	1398	1005	0	2703	0	1069	1548	0	544	1325	0
Satd. Flow (RTOR)			76		57			9			5	
Lane Group Flow (vph)	0	409	76	0	853	0	136	282	0	20	61	0
Turn Type	Perm	NA	Perm	Perm	NA		Perm	NA		Perm	NA	
Protected Phases		2			6			8			4	
Permitted Phases	2		2	6			8			4		
Total Split (s)	61.0	61.0	61.0	61.0	61.0		39.0	39.0		39.0	39.0	
Total Lost Time (s)		5.9	5.9		5.9		5.9	5.9		5.9	5.9	
Act Effct Green (s)		64.9	64.9		64.9		23.3	23.3		23.3	23.3	
Actuated g/C Ratio		0.65	0.65		0.65		0.23	0.23		0.23	0.23	
v/c Ratio		0.45	0.11		0.48		0.55	0.77		0.16	0.19	
Control Delay		12.0	2.7		7.9		40.7	47.8		30.4	27.6	
Queue Delay		0.0	0.0		0.0		0.0	0.0		0.0	0.0	
Total Delay		12.0	2.7		7.9		40.7	47.8		30.4	27.6	
LOS		B	A		A		D	D		C	C	
Approach Delay		10.6			7.9			45.5			28.3	
Approach LOS		B			A			D			C	
Queue Length 50th (m)		35.4	0.0		28.0		23.3	49.8		3.1	8.8	
Queue Length 95th (m)		71.4	6.0		40.9		37.7	70.0		8.6	17.2	
Internal Link Dist (m)		440.1			309.1			439.9			191.0	
Turn Bay Length (m)			60.0				65.0			60.0		
Base Capacity (vph)		906	678		1773		353	518		180	441	
Starvation Cap Reductn		0	0		0		0	0		0	0	
Spillback Cap Reductn		0	0		0		0	0		0	0	
Storage Cap Reductn		0	0		0		0	0		0	0	
Reduced v/c Ratio		0.45	0.11		0.48		0.39	0.54		0.11	0.14	

Intersection Summary

Cycle Length: 100
 Actuated Cycle Length: 100
 Offset: 65 (65%), Referenced to phase 2:EBTL and 6:WBTL, Start of Green
 Control Type: Actuated-Coordinated
 Maximum v/c Ratio: 0.77
 Intersection Signal Delay: 18.0
 Intersection Capacity Utilization 71.5%
 Analysis Period (min) 15

Intersection LOS: B
 ICU Level of Service C

Splits and Phases: 5: Oxford & Bayers

Ø2 (R)		Ø4
61 s		39 s
Ø6 (R)		Ø8
61 s		39 s

Lane Group	EBL	EBT	EBR	WBL	WBT	WBR	NBL	NBT	NBR	SBL	SBT	SBR
Lane Configurations												
Traffic Volume (vph)	90	410	50	140	420	150	120	455	140	60	190	0
Future Volume (vph)	90	410	50	140	420	150	120	455	140	60	190	0
Satd. Flow (prot)	1479	1560	0	1449	2948	0	1486	1638	1408	1501	1580	0
Fit Permitted	0.430			0.200			0.541			0.462		
Satd. Flow (perm)	669	1560	0	303	2948	0	835	1638	1372	725	1580	0
Satd. Flow (RTOR)		6		64					144			
Lane Group Flow (vph)	93	475	0	144	588	0	124	469	144	62	196	0
Turn Type	Perm	NA		pm+pt	NA		pm+pt	NA	Perm	Perm	NA	
Protected Phases		2		1	6		3	8			4	
Permitted Phases	2			6			8		8	4		
Total Split (s)	39.0	39.0		11.0	50.0		11.0	50.0	50.0	39.0	39.0	
Total Lost Time (s)	7.1	7.1		4.0	7.0		4.0	7.0	7.0	7.0	7.0	
Act Effct Green (s)	31.9	31.9		46.0	43.0		46.0	43.0	43.0	32.0	32.0	
Actuated g/C Ratio	0.32	0.32		0.46	0.43		0.46	0.43	0.43	0.32	0.32	
v/c Ratio	0.44	0.95		0.66	0.45		0.29	0.67	0.21	0.27	0.39	
Control Delay	30.0	58.0		32.8	19.1		18.0	28.5	3.9	29.2	29.2	
Queue Delay	0.0	0.0		0.0	0.0		0.0	0.0	0.0	0.0	0.0	
Total Delay	30.0	58.0		32.8	19.1		18.0	28.5	3.9	29.2	29.2	
LOS	C	E		C	B		B	C	A	C	C	
Approach Delay		53.4			21.8			21.9			29.2	
Approach LOS		D			C			C			C	
Queue Length 50th (m)	9.5	90.2		16.2	36.5		13.7	70.8	0.0	8.9	29.3	
Queue Length 95th (m)	20.8	#145.7		#32.3	50.9		24.9	106.0	10.6	20.0	48.7	
Internal Link Dist (m)		309.1			142.1			493.5			927.7	
Turn Bay Length (m)	50.0			40.0			90.0		50.0	40.0		
Base Capacity (vph)	213	501		219	1304		429	704	672	232	505	
Starvation Cap Reductn	0	0		0	0		0	0	0	0	0	
Spillback Cap Reductn	0	0		0	0		0	0	0	0	0	
Storage Cap Reductn	0	0		0	0		0	0	0	0	0	
Reduced v/c Ratio	0.44	0.95		0.66	0.45		0.29	0.67	0.21	0.27	0.39	

Intersection Summary

Cycle Length: 100
 Actuated Cycle Length: 100
 Offset: 77 (77%), Referenced to phase 2:EBTL and 6:WBT, Start of Green
 Control Type: Actuated-Coordinated
 Maximum v/c Ratio: 0.95
 Intersection Signal Delay: 30.5
 Intersection Capacity Utilization 92.3%
 Analysis Period (min) 15
 # 95th percentile volume exceeds capacity, queue may be longer.
 Queue shown is maximum after two cycles.

Intersection LOS: C
 ICU Level of Service F

Splits and Phases: 6: Windsor & Bayers/Young

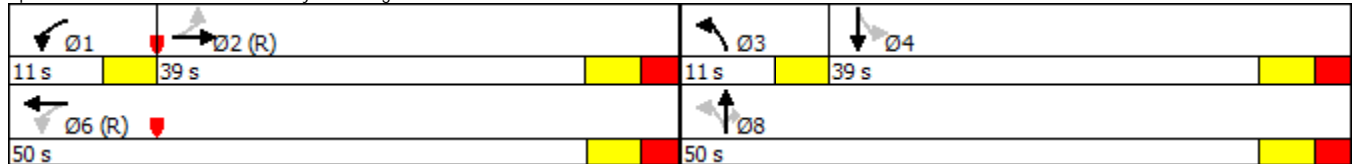

Lane Group	EBL	EBT	EBR	WBT	WBR	NBL2	NBT	SBL2	SBT
Lane Configurations									
Traffic Volume (vph)	5	1770	15	840	10	60	60	20	35
Future Volume (vph)	5	1770	15	840	10	60	60	20	35
Lane Group Flow (vph)	0	1868	106	884	16	63	68	0	100
Turn Type	Perm	NA	Perm	NA	Perm	Perm	NA	Perm	NA
Protected Phases		2		2			4		4
Permitted Phases	2		2		2	4		4	
Detector Phase	2	2	2	2	2	4	4	4	4
Switch Phase									
Minimum Initial (s)	10.0	10.0	10.0	10.0	10.0	10.0	10.0	10.0	10.0
Minimum Split (s)	23.8	23.8	23.8	23.8	23.8	29.1	29.1	29.1	29.1
Total Split (s)	80.0	80.0	80.0	80.0	80.0	30.0	30.0	30.0	30.0
Total Split (%)	72.7%	72.7%	72.7%	72.7%	72.7%	27.3%	27.3%	27.3%	27.3%
Yellow Time (s)	4.1	4.1	4.1	4.1	4.1	4.1	4.1	4.1	4.1
All-Red Time (s)	1.7	1.7	1.7	1.7	1.7	2.0	2.0	2.0	2.0
Lost Time Adjust (s)		0.0	0.0	0.0	0.0	0.0	0.0	0.0	0.0
Total Lost Time (s)		5.8	5.8	5.8	5.8	6.1	6.1		6.1
Lead/Lag									
Lead-Lag Optimize?									
Recall Mode	C-Min	C-Min	C-Min	C-Min	C-Min	Ped	Ped	Ped	Ped
Act Effct Green (s)		75.1	75.1	75.1	75.1	23.0	23.0		23.0
Actuated g/C Ratio		0.68	0.68	0.68	0.68	0.21	0.21		0.21
v/c Ratio		0.95	0.12	0.42	0.02	0.29	0.21		0.35
Control Delay		27.7	2.0	4.8	0.2	40.9	38.1		41.4
Queue Delay		0.0	0.0	0.0	0.0	0.0	0.0		0.0
Total Delay		27.7	2.0	4.8	0.2	40.9	38.1		41.4
LOS		C	A	A	A	D	D		D
Approach Delay		26.4		4.7			39.5		41.4
Approach LOS		C		A			D		D
Queue Length 50th (m)		169.8	1.1	31.0	0.2	11.5	12.2		18.5
Queue Length 95th (m)		#250.2	6.2	22.1	m0.0	24.1	24.5		34.4
Internal Link Dist (m)		76.6		386.3			826.4		535.1
Turn Bay Length (m)					80.0	40.0			
Base Capacity (vph)		1972	880	2117	841	227	335		295
Starvation Cap Reductn		0	0	0	0	0	0		0
Spillback Cap Reductn		0	0	0	0	0	0		0
Storage Cap Reductn		0	0	0	0	0	0		0
Reduced v/c Ratio		0.95	0.12	0.42	0.02	0.28	0.20		0.34

Intersection Summary

Cycle Length: 110
 Actuated Cycle Length: 110
 Offset: 8 (7%), Referenced to phase 2:EBWB and 6:, Start of Green
 Natural Cycle: 100
 Control Type: Actuated-Coordinated
 Maximum v/c Ratio: 0.95
 Intersection Signal Delay: 21.1
 Intersection Capacity Utilization 103.8%
 Analysis Period (min) 15
 # 95th percentile volume exceeds capacity, queue may be longer.
 Queue shown is maximum after two cycles.
 m Volume for 95th percentile queue is metered by upstream signal.

Splits and Phases: 1: Romans & Bayers

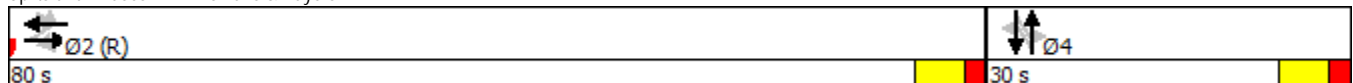

Halifax Transit Priority Corridors

4: Connaught & Bayers

Lane Group	EBL	EBT	EBR	WBT	WBR	NBL	NBT	SBT	SBR
Lane Configurations									
Traffic Volume (vph)	305	700	900	481	109	162	303	185	187
Future Volume (vph)	305	700	900	481	109	162	303	185	187
Lane Group Flow (vph)	318	729	938	501	114	169	410	193	195
Turn Type	pm+pt	NA	Perm	NA	Perm	Prot	NA	NA	pt+ov
Protected Phases	5	2		6		3	8	4	4.5
Permitted Phases	2		2		6				
Detector Phase	5	2	2	6	6	3	8	4	4.5
Switch Phase									
Minimum Initial (s)	7.0	10.0	10.0	10.0	10.0	7.0	10.0	10.0	
Minimum Split (s)	12.0	42.9	42.9	42.9	42.9	14.0	30.2	30.2	
Total Split (s)	17.0	61.0	61.0	44.0	44.0	18.0	49.0	31.0	
Total Split (%)	15.5%	55.5%	55.5%	40.0%	40.0%	16.4%	44.5%	28.2%	
Yellow Time (s)	5.0	4.1	4.1	4.1	4.1	4.0	4.1	4.1	
All-Red Time (s)	0.0	2.8	2.8	2.8	2.8	3.0	2.1	2.1	
Lost Time Adjust (s)	-1.0	-1.0	-1.0	-1.0	0.0	-1.0	-1.0	-1.0	
Total Lost Time (s)	4.0	5.9	5.9	5.9	6.9	6.0	5.2	5.2	
Lead/Lag	Lead			Lag	Lag	Lead		Lag	
Lead-Lag Optimize?									
Recall Mode	Max	C-Max	C-Max	C-Max	C-Max	Max	Ped	Ped	
Act Effct Green (s)	57.6	55.7	55.7	38.1	37.1	12.0	43.2	25.2	42.8
Actuated g/C Ratio	0.52	0.51	0.51	0.35	0.34	0.11	0.39	0.23	0.39
v/c Ratio	0.76	0.88	0.99	0.49	0.21	0.52	0.66	0.28	0.21
Control Delay	17.9	24.2	26.1	26.3	4.2	52.3	32.6	34.5	21.7
Queue Delay	0.0	0.0	0.0	0.0	0.0	0.0	0.0	0.0	0.0
Total Delay	17.9	24.2	26.1	26.3	4.2	52.3	32.6	34.5	21.7
LOS	B	C	C	C	A	D	C	C	C
Approach Delay		24.1		22.2			38.3	28.0	
Approach LOS		C		C			D	C	
Queue Length 50th (m)	15.8	85.8	0.0	38.2	1.1	17.9	68.8	18.1	15.5
Queue Length 95th (m)	m23.6	m125.1	m#170.6	62.6	5.1	28.7	102.2	28.5	25.3
Internal Link Dist (m)		119.1		146.3			461.8	84.0	
Turn Bay Length (m)	90.0				80.0	110.0			35.0
Base Capacity (vph)	420	827	951	1024	552	328	626	712	854
Starvation Cap Reductn	0	0	0	0	0	0	0	0	0
Spillback Cap Reductn	0	0	0	0	0	0	0	0	0
Storage Cap Reductn	0	0	0	0	0	0	0	0	0
Reduced v/c Ratio	0.76	0.88	0.99	0.49	0.21	0.52	0.65	0.27	0.23

Intersection Summary

Cycle Length: 110
 Actuated Cycle Length: 110
 Offset: 70 (64%), Referenced to phase 2:EBTL and 6:WBT, Start of Green
 Natural Cycle: 110
 Control Type: Actuated-Coordinated
 Maximum v/c Ratio: 0.99
 Intersection Signal Delay: 26.5
 Intersection Capacity Utilization 94.7%
 Analysis Period (min) 15
 # 95th percentile volume exceeds capacity, queue may be longer.
 Queue shown is maximum after two cycles.
 m Volume for 95th percentile queue is metered by upstream signal.

Splits and Phases: 4: Connaught & Bayers

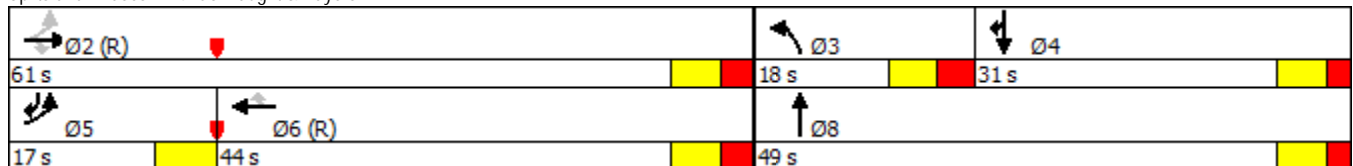

Halifax Transit Priority Corridors

5: Oxford & Bayers

Lane Group	EBT	EBR	WBL	WBT	WBR	NBL	NBT	SBL	SBT
Lane Configurations									
Traffic Volume (vph)	501	206	19	304	28	99	103	22	103
Future Volume (vph)	501	206	19	304	28	99	103	22	103
Lane Group Flow (vph)	522	215	0	337	29	103	145	23	108
Turn Type	NA	Perm	Perm	NA	Perm	Perm	NA	Perm	NA
Protected Phases	2			6			8		4
Permitted Phases		2	6		6	8		4	
Detector Phase	2	2	6	6	6	8	8	4	4
Switch Phase									
Minimum Initial (s)	10.0	10.0	10.0	10.0	10.0	10.0	10.0	10.0	10.0
Minimum Split (s)	24.9	24.9	24.9	24.9	24.9	23.9	23.9	23.9	23.9
Total Split (s)	78.0	78.0	78.0	78.0	78.0	32.0	32.0	32.0	32.0
Total Split (%)	70.9%	70.9%	70.9%	70.9%	70.9%	29.1%	29.1%	29.1%	29.1%
Yellow Time (s)	4.1	4.1	4.1	4.1	4.1	4.1	4.1	4.1	4.1
All-Red Time (s)	1.8	1.8	1.8	1.8	1.8	1.8	1.8	1.8	1.8
Lost Time Adjust (s)	0.0	0.0		0.0	0.0	0.0	0.0	0.0	0.0
Total Lost Time (s)	5.9	5.9		5.9	5.9	5.9	5.9	5.9	5.9
Lead/Lag									
Lead-Lag Optimize?									
Recall Mode	C-Max	C-Max	C-Max	C-Max	C-Max	None	None	None	None
Act Effct Green (s)	81.6	81.6		81.6	81.6	16.6	16.6	16.6	16.6
Actuated g/C Ratio	0.74	0.74		0.74	0.74	0.15	0.15	0.15	0.15
v/c Ratio	0.50	0.26		0.30	0.03	0.67	0.61	0.19	0.53
Control Delay	2.6	0.4		6.2	3.2	63.9	49.1	42.0	51.4
Queue Delay	0.0	0.0		0.0	0.0	0.0	0.0	0.0	0.0
Total Delay	2.6	0.4		6.2	3.2	63.9	49.1	42.0	51.4
LOS	A	A		A	A	E	D	D	D
Approach Delay	2.0			6.0			55.3		49.8
Approach LOS	A			A			E		D
Queue Length 50th (m)	11.1	0.0		12.9	0.0	21.2	26.5	4.4	21.7
Queue Length 95th (m)	m13.9	m0.0		m40.8	m2.8	36.7	43.2	11.2	36.2
Internal Link Dist (m)	269.4			309.1			518.4		229.7
Turn Bay Length (m)		60.0			60.0	65.0		60.0	
Base Capacity (vph)	1052	821		1124	974	241	363	185	318
Starvation Cap Reductn	0	0		0	0	0	0	0	0
Spillback Cap Reductn	0	0		0	0	0	0	0	0
Storage Cap Reductn	0	0		0	0	0	0	0	0
Reduced v/c Ratio	0.50	0.26		0.30	0.03	0.43	0.40	0.12	0.34

Intersection Summary

Cycle Length: 110
 Actuated Cycle Length: 110
 Offset: 76 (69%), Referenced to phase 2:EBTL and 6:WBTL, Start of Green
 Natural Cycle: 60
 Control Type: Actuated-Coordinated
 Maximum v/c Ratio: 0.67
 Intersection Signal Delay: 16.1
 Intersection Capacity Utilization 73.3%
 Analysis Period (min) 15
 m Volume for 95th percentile queue is metered by upstream signal.

Intersection LOS: B
 ICU Level of Service D

Splits and Phases: 5: Oxford & Bayers

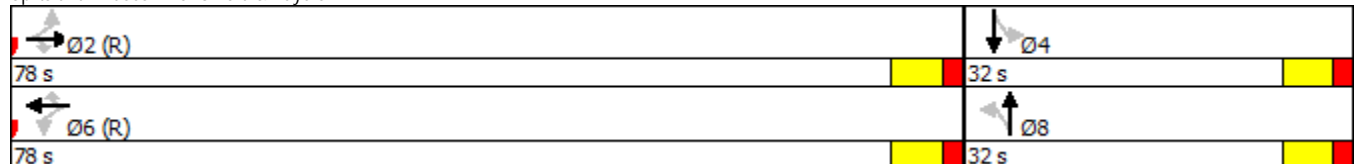

Lane Group	EBL	EBT	EBR	WBL	WBT	WBR	NBL	NBT	NBR	SBL	SBT
Lane Configurations											
Traffic Volume (vph)	52	457	79	53	243	99	76	180	151	108	436
Future Volume (vph)	52	457	79	53	243	99	76	180	151	108	436
Lane Group Flow (vph)	56	491	85	57	261	106	82	194	162	116	514
Turn Type	Perm	NA	Perm	pm+pt	NA	Perm	Perm	NA	Perm	pm+pt	NA
Protected Phases		2		1	6			8		7	4
Permitted Phases	2		2	6		6	8		8	4	
Detector Phase	2	2	2	1	6	6	8	8		7	4
Switch Phase											
Minimum Initial (s)	10.0	10.0	10.0	7.0	10.0	10.0	10.0	10.0	10.0	7.0	10.0
Minimum Split (s)	31.1	31.1	31.1	11.0	31.0	31.0	39.0	39.0	39.0	11.0	39.0
Total Split (s)	49.0	49.0	49.0	11.0	60.0	60.0	39.0	39.0	39.0	11.0	50.0
Total Split (%)	44.5%	44.5%	44.5%	10.0%	54.5%	54.5%	35.5%	35.5%	35.5%	10.0%	45.5%
Yellow Time (s)	4.1	4.1	4.1	4.0	4.0	4.0	4.1	4.1	4.1	4.0	4.1
All-Red Time (s)	3.0	3.0	3.0	0.0	3.0	3.0	2.9	2.9	2.9	0.0	2.9
Lost Time Adjust (s)	0.0	0.0	0.0	0.0	0.0	0.0	0.0	0.0	0.0	0.0	0.0
Total Lost Time (s)	7.1	7.1	7.1	4.0	7.0	7.0	7.0	7.0	7.0	4.0	7.0
Lead/Lag	Lag	Lag	Lag	Lead			Lag	Lag	Lag	Lead	
Lead-Lag Optimize?											
Recall Mode	C-Max	C-Max	C-Max	None	C-Max	C-Max	Ped	Ped	Ped	None	None
Act Effct Green (s)	44.1	44.1	44.1	56.0	53.0	53.0	32.0	32.0	32.0	46.0	43.0
Actuated g/C Ratio	0.40	0.40	0.40	0.51	0.48	0.48	0.29	0.29	0.29	0.42	0.39
v/c Ratio	0.15	0.79	0.14	0.22	0.34	0.15	0.54	0.42	0.32	0.31	0.86
Control Delay	12.3	26.9	1.2	15.9	19.3	3.6	47.7	34.8	6.4	22.8	45.9
Queue Delay	0.0	0.0	0.0	0.0	0.0	0.0	0.0	0.0	0.0	0.0	0.0
Total Delay	12.3	26.9	1.2	15.9	19.3	3.6	47.7	34.8	6.4	22.8	45.9
LOS	B	C	A	B	B	A	D	C	A	C	D
Approach Delay		22.2			14.9			26.7			41.7
Approach LOS		C			B			C			D
Queue Length 50th (m)	5.1	89.1	0.5	6.0	33.7	0.0	14.8	33.6	0.0	15.4	98.6
Queue Length 95th (m)	m10.8	#147.5	2.5	12.7	52.3	8.8	31.8	54.5	15.0	27.5	#158.0
Internal Link Dist (m)		309.1			142.1			569.0			312.0
Turn Bay Length (m)	50.0		60.0	40.0		60.0	90.0		50.0	40.0	
Base Capacity (vph)	365	625	603	263	764	704	153	467	507	378	601
Starvation Cap Reductn	0	0	0	0	0	0	0	0	0	0	0
Spillback Cap Reductn	0	0	0	0	0	0	0	0	0	0	0
Storage Cap Reductn	0	0	0	0	0	0	0	0	0	0	0
Reduced v/c Ratio	0.15	0.79	0.14	0.22	0.34	0.15	0.54	0.42	0.32	0.31	0.86

Intersection Summary





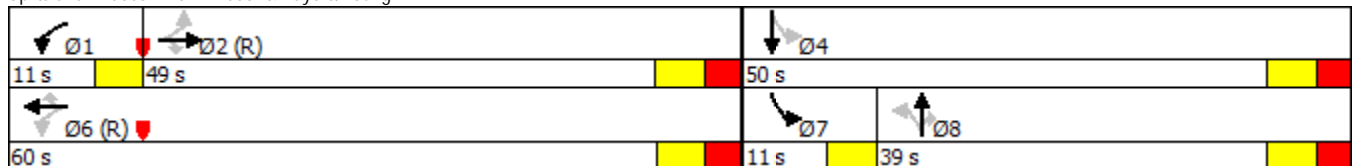





Cycle Length: 110
 Actuated Cycle Length: 110
 Offset: 14 (13%), Referenced to phase 2:EBTL and 6:WBTL, Start of Green
 Natural Cycle: 95
 Control Type: Actuated-Coordinated
 Maximum v/c Ratio: 0.86
 Intersection Signal Delay: 27.4
 Intersection Capacity Utilization 90.5%
 Analysis Period (min) 15
 # 95th percentile volume exceeds capacity, queue may be longer.
 Queue shown is maximum after two cycles.
 m Volume for 95th percentile queue is metered by upstream signal.

Splits and Phases: 6: Windsor & Bayers/Young



Halifax Transit Priority Corridors

7: Connaught & HSC

					
Lane Group	EBL	EBR	NBL	NBT	SBT
Lane Configurations					 
Traffic Volume (vph)	20	35	122	575	337
Future Volume (vph)	20	35	122	575	337
Lane Group Flow (vph)	22	39	136	639	483
Turn Type	Prot	Perm	Perm	NA	NA
Protected Phases	8			6	2
Permitted Phases		8	6		
Detector Phase	8	8	6	6	2
Switch Phase					
Minimum Initial (s)	8.0	8.0	8.0	8.0	8.0
Minimum Split (s)	24.0	24.0	24.0	24.0	24.0
Total Split (s)	26.0	26.0	84.0	84.0	84.0
Total Split (%)	23.6%	23.6%	76.4%	76.4%	76.4%
Yellow Time (s)	4.0	4.0	4.0	4.0	4.0
All-Red Time (s)	2.0	2.0	2.0	2.0	2.0
Lost Time Adjust (s)	0.0	0.0	0.0	0.0	0.0
Total Lost Time (s)	6.0	6.0	6.0	6.0	6.0
Lead/Lag					
Lead-Lag Optimize?					
Recall Mode	None	None	C-Min	C-Min	C-Min
Act Effct Green (s)	8.3	8.3	93.7	93.7	93.7
Actuated g/C Ratio	0.08	0.08	0.85	0.85	0.85
v/c Ratio	0.19	0.28	0.20	0.46	0.19
Control Delay	51.5	20.2	2.2	2.9	1.8
Queue Delay	0.0	0.0	0.0	0.6	0.0
Total Delay	51.5	20.2	2.2	3.5	1.8
LOS	D	C	A	A	A
Approach Delay	31.5			3.3	1.8
Approach LOS	C			A	A
Queue Length 50th (m)	4.5	0.0	4.0	22.7	7.2
Queue Length 95th (m)	12.3	10.2	m5.6	23.3	11.1
Internal Link Dist (m)	378.7			84.0	290.6
Turn Bay Length (m)	50.0				
Base Capacity (vph)	284	286	669	1404	2539
Starvation Cap Reductn	0	0	0	408	0
Spillback Cap Reductn	0	0	0	0	0
Storage Cap Reductn	0	0	0	0	0
Reduced v/c Ratio	0.08	0.14	0.20	0.64	0.19

Intersection Summary

Cycle Length: 110
 Actuated Cycle Length: 110
 Offset: 65 (59%), Referenced to phase 2:SBT and 6:NBTL, Start of Green
 Natural Cycle: 60
 Control Type: Actuated-Coordinated
 Maximum v/c Ratio: 0.46
 Intersection Signal Delay: 4.0
 Intersection Capacity Utilization 50.5%
 Analysis Period (min) 15
 m Volume for 95th percentile queue is metered by upstream signal.





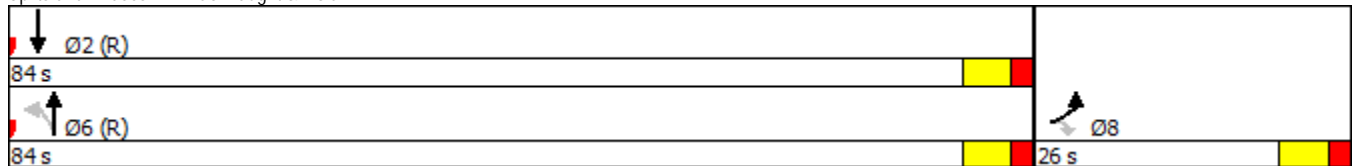





Intersection LOS: A
ICU Level of Service A

Splits and Phases: 7: Connaught & HSC

















Halifax Transit Priority Corridors

2: HSC W & Bayers

						
Movement	EBT	EBR	WBL	WBT	NBL	NBR
Lane Configurations						
Traffic Volume (veh/h)	1775	50	0	830	0	130
Future Volume (Veh/h)	1775	50	0	830	0	130
Sign Control	Free			Free	Stop	
Grade	0%			0%	0%	
Peak Hour Factor	0.90	0.90	0.90	0.90	0.90	0.90
Hourly flow rate (vph)	1972	56	0	922	0	144
Pedestrians						
Lane Width (m)						
Walking Speed (m/s)						
Percent Blockage						
Right turn flare (veh)						
Median type	None			None		
Median storage (veh)						
Upstream signal (m)				183		
pX, platoon unblocked					0.89	
vC, conflicting volume			2028		2433	986
vC1, stage 1 conf vol						
vC2, stage 2 conf vol						
vCu, unblocked vol			2028		2363	986
IC, single (s)			4.1		6.8	6.9
IC, 2 stage (s)						
IF (s)			2.2		3.5	3.3
p0 queue free %			100		100	42
cM capacity (veh/h)			276		26	247
Direction, Lane #	EB 1	EB 2	EB 3	WB 1	WB 2	NB 1
Volume Total	986	986	56	461	461	144
Volume Left	0	0	0	0	0	0
Volume Right	0	0	56	0	0	144
cSH	1700	1700	1700	1700	1700	247
Volume to Capacity	0.58	0.58	0.03	0.27	0.27	0.58
Queue Length 95th (m)	0.0	0.0	0.0	0.0	0.0	25.4
Control Delay (s)	0.0	0.0	0.0	0.0	0.0	38.2
Lane LOS						E
Approach Delay (s)	0.0			0.0		38.2
Approach LOS						E
Intersection Summary						
Average Delay			1.8			
Intersection Capacity Utilization			70.5%		ICU Level of Service	C
Analysis Period (min)			15			

Halifax Transit Priority Corridors

1: Romans & Bayers

								
Lane Group	EBT	EBR	WBT	WBR	NBL2	NBT	SBL2	SBT
Lane Configurations								
Traffic Volume (vph)	1485	10	2110	15	120	75	5	30
Future Volume (vph)	1485	10	2110	15	120	75	5	30
Lane Group Flow (vph)	1500	127	2131	22	121	91	0	308
Turn Type	NA	Perm	NA	Perm	Perm	NA	Perm	NA
Protected Phases	2		2			4		4
Permitted Phases		2		2	4		4	
Detector Phase	2	2	2	2	4	4	4	4
Switch Phase								
Minimum Initial (s)	10.0	10.0	10.0	10.0	10.0	10.0	10.0	10.0
Minimum Split (s)	23.8	23.8	23.8	23.8	29.1	29.1	29.1	29.1
Total Split (s)	94.0	94.0	94.0	94.0	36.0	36.0	36.0	36.0
Total Split (%)	72.3%	72.3%	72.3%	72.3%	27.7%	27.7%	27.7%	27.7%
Yellow Time (s)	4.1	4.1	4.1	4.1	4.1	4.1	4.1	4.1
All-Red Time (s)	1.7	1.7	1.7	1.7	2.0	2.0	2.0	2.0
Lost Time Adjust (s)	0.0	0.0	0.0	0.0	0.0	0.0	0.0	0.0
Total Lost Time (s)	5.8	5.8	5.8	5.8	6.1	6.1		6.1
Lead/Lag								
Lead-Lag Optimize?								
Recall Mode	C-Min	C-Min	C-Min	C-Min	Ped	Ped	Ped	Ped
Act Effct Green (s)	88.2	88.2	88.2	88.2	29.9	29.9		29.9
Actuated g/C Ratio	0.68	0.68	0.68	0.68	0.23	0.23		0.23
v/c Ratio	0.72	0.14	1.00	0.03	1.10	0.26		1.01
Control Delay	15.7	1.9	29.0	1.1	161.9	43.4		102.9
Queue Delay	0.0	0.0	0.0	0.0	0.0	0.0		0.0
Total Delay	15.7	1.9	29.0	1.1	161.9	43.4		102.9
LOS	B	A	C	A	F	D		F
Approach Delay	14.7		28.7			111.0		102.9
Approach LOS	B		C			F		F
Queue Length 50th (m)	117.1	0.8	-205.6	0.0	-35.0	19.2		-80.0
Queue Length 95th (m)	143.1	7.1	m#315.6	m0.0	#73.9	34.8		#138.7
Internal Link Dist (m)	1417.0		385.8			886.2		555.5
Turn Bay Length (m)		80.0		80.0	40.0			
Base Capacity (vph)	2076	877	2124	775	110	352		306
Starvation Cap Reductn	0	0	0	0	0	0		0
Spillback Cap Reductn	0	0	0	0	0	0		0
Storage Cap Reductn	0	0	0	0	0	0		0
Reduced v/c Ratio	0.72	0.14	1.00	0.03	1.10	0.26		1.01

Intersection Summary

Cycle Length: 130
 Actuated Cycle Length: 130
 Offset: 57 (44%), Referenced to phase 2:EBWB and 6:, Start of Green
 Natural Cycle: 120
 Control Type: Actuated-Coordinated
 Maximum v/c Ratio: 1.10
 Intersection Signal Delay: 32.8
 Intersection Capacity Utilization 123.3%
 Analysis Period (min) 15
 ~ Volume exceeds capacity, queue is theoretically infinite.
 Queue shown is maximum after two cycles.
 # 95th percentile volume exceeds capacity, queue may be longer.
 Queue shown is maximum after two cycles.
 m Volume for 95th percentile queue is metered by upstream signal.

Splits and Phases: 1: Romans & Bayers



Halifax Transit Priority Corridors

4: Connaught & Bayers

Lane Group	EBL	EBT	EBR	WBT	WBR	NBL	NBT	SBT	SBR
Lane Configurations									
Traffic Volume (vph)	161	515	575	820	90	744	181	130	561
Future Volume (vph)	161	515	575	820	90	744	181	130	561
Lane Group Flow (vph)	168	536	599	854	94	775	225	135	584
Turn Type	pm+pt	NA	Perm	NA	Perm	Prot	NA	NA	pt+ov
Protected Phases	5	2		6		3	8	4	4.5
Permitted Phases	2		2		6				
Detector Phase	5	2	2	6	6	3	8	4	4.5
Switch Phase									
Minimum Initial (s)	7.0	10.0	10.0	10.0	10.0	7.0	10.0	10.0	
Minimum Split (s)	12.0	42.9	42.9	42.9	42.9	14.0	30.2	30.2	
Total Split (s)	15.0	59.0	59.0	44.0	44.0	40.0	71.0	31.0	
Total Split (%)	11.5%	45.4%	45.4%	33.8%	33.8%	30.8%	54.6%	23.8%	
Yellow Time (s)	5.0	4.1	4.1	4.1	4.1	4.0	4.1	4.1	
All-Red Time (s)	0.0	2.8	2.8	2.8	2.8	3.0	2.1	2.1	
Lost Time Adjust (s)	-1.0	-1.0	-1.0	-1.0	0.0	-1.0	-1.0	-1.0	
Total Lost Time (s)	4.0	5.9	5.9	5.9	6.9	6.0	5.2	5.2	
Lead/Lag	Lead			Lag	Lag	Lead		Lag	
Lead-Lag Optimize?									
Recall Mode	Max	C-Max	C-Max	C-Max	C-Max	Max	Ped	Ped	
Act Effect Green (s)	55.0	53.1	53.1	38.1	37.1	34.0	65.8	25.8	40.8
Actuated g/C Ratio	0.42	0.41	0.41	0.29	0.29	0.26	0.51	0.20	0.31
v/c Ratio	0.89	0.80	0.68	0.99	0.20	0.99	0.28	0.22	0.78
Control Delay	58.3	36.8	14.3	74.0	3.2	76.6	18.7	44.9	48.9
Queue Delay	0.0	0.0	0.0	0.0	0.0	0.0	0.0	0.0	0.5
Total Delay	58.3	36.8	14.3	74.0	3.2	76.6	18.7	44.9	49.3
LOS	E	D	B	E	A	E	B	D	D
Approach Delay		29.2		67.0			63.6	48.5	
Approach LOS		C		E			E	D	
Queue Length 50th (m)	30.2	128.3	68.7	114.7	0.0	102.2	30.5	15.4	77.1
Queue Length 95th (m)	m#58.2	178.5	127.1	#158.0	6.0	#142.8	47.5	24.8	101.5
Internal Link Dist (m)		119.7		132.1			1920.3	104.0	
Turn Bay Length (m)	90.0				80.0	110.0			35.0
Base Capacity (vph)	189	666	878	863	470	786	802	603	751
Starvation Cap Reductn	0	0	0	0	0	0	0	0	23
Spillback Cap Reductn	0	0	0	0	0	0	0	0	0
Storage Cap Reductn	0	0	0	0	0	0	0	0	0
Reduced v/c Ratio	0.89	0.80	0.68	0.99	0.20	0.99	0.28	0.22	0.80

Intersection Summary

Cycle Length: 130
 Actuated Cycle Length: 130
 Offset: 26 (20%), Referenced to phase 2:EBTL and 6:WBT, Start of Green
 Natural Cycle: 120
 Control Type: Actuated-Coordinated
 Maximum v/c Ratio: 0.99
 Intersection Signal Delay: 50.4
 Intersection Capacity Utilization 100.6%
 Analysis Period (min) 15
 # 95th percentile volume exceeds capacity, queue may be longer.
 Queue shown is maximum after two cycles.
 m Volume for 95th percentile queue is metered by upstream signal.

Splits and Phases: 4: Connaught & Bayers

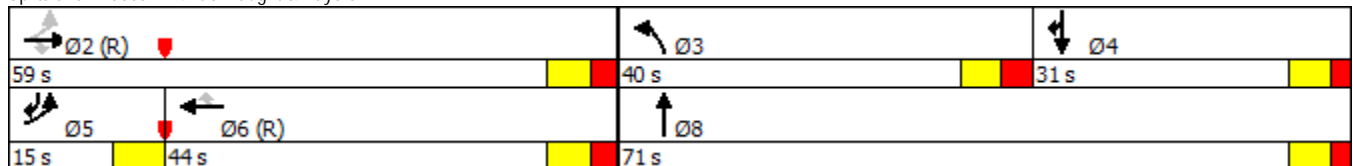

Halifax Transit Priority Corridors

5: Oxford & Bayers

Lane Group	EBL	EBT	EBR	WBL	WBT	WBR	NBL	NBT	SBL	SBT
Lane Configurations										
Traffic Volume (vph)	10	395	75	20	640	185	135	240	20	55
Future Volume (vph)	10	395	75	20	640	185	135	240	20	55
Lane Group Flow (vph)	0	409	76	0	666	187	136	282	20	61
Turn Type	Perm	NA	Perm	Perm	NA	Perm	Perm	NA	Perm	NA
Protected Phases		2			6			8		4
Permitted Phases	2		2	6		6	8		4	
Detector Phase	2	2	2	6	6	6	8	8	4	4
Switch Phase										
Minimum Initial (s)	10.0	10.0	10.0	10.0	10.0	10.0	10.0	10.0	10.0	10.0
Minimum Split (s)	24.9	24.9	24.9	24.9	24.9	24.9	23.9	23.9	23.9	23.9
Total Split (s)	61.0	61.0	61.0	61.0	61.0	61.0	39.0	39.0	39.0	39.0
Total Split (%)	61.0%	61.0%	61.0%	61.0%	61.0%	61.0%	39.0%	39.0%	39.0%	39.0%
Yellow Time (s)	4.1	4.1	4.1	4.1	4.1	4.1	4.1	4.1	4.1	4.1
All-Red Time (s)	1.8	1.8	1.8	1.8	1.8	1.8	1.8	1.8	1.8	1.8
Lost Time Adjust (s)		0.0	0.0		0.0	0.0	0.0	0.0	0.0	0.0
Total Lost Time (s)		5.9	5.9		5.9	5.9	5.9	5.9	5.9	5.9
Lead/Lag										
Lead-Lag Optimize?										
Recall Mode	C-Max	C-Max	C-Max	C-Max	C-Max	C-Max	None	None	None	None
Act Effct Green (s)		64.9	64.9		64.9	64.9	23.3	23.3	23.3	23.3
Actuated g/C Ratio		0.65	0.65		0.65	0.65	0.23	0.23	0.23	0.23
v/c Ratio		0.45	0.11		0.66	0.20	0.56	0.77	0.16	0.20
Control Delay		12.0	2.7		11.9	1.5	41.2	47.8	30.4	27.6
Queue Delay		0.0	0.0		0.0	0.0	0.0	0.0	0.0	0.0
Total Delay		12.0	2.7		11.9	1.5	41.2	47.8	30.4	27.6
LOS		B	A		B	A	D	D	C	C
Approach Delay		10.5			9.6			45.7		28.3
Approach LOS		B			A			D		C
Queue Length 50th (m)		35.4	0.0		49.9	0.0	23.4	49.8	3.1	8.8
Queue Length 95th (m)		71.1	6.0		82.6	4.8	37.9	70.0	8.6	17.2
Internal Link Dist (m)		283.7			309.1			439.9		191.0
Turn Bay Length (m)			60.0			60.0	65.0		60.0	
Base Capacity (vph)		913	678		1006	920	348	518	180	441
Starvation Cap Reductn		0	0		0	0	0	0	0	0
Spillback Cap Reductn		0	0		0	0	0	0	0	0
Storage Cap Reductn		0	0		0	0	0	0	0	0
Reduced v/c Ratio		0.45	0.11		0.66	0.20	0.39	0.54	0.11	0.14

Intersection Summary

Cycle Length: 100
 Actuated Cycle Length: 100
 Offset: 65 (65%), Referenced to phase 2:EBTL and 6:WBTL, Start of Green
 Natural Cycle: 60
 Control Type: Actuated-Coordinated
 Maximum v/c Ratio: 0.77
 Intersection Signal Delay: 18.9
 Intersection Capacity Utilization 84.1%
 Analysis Period (min) 15

Intersection LOS: B
 ICU Level of Service E

Splits and Phases: 5: Oxford & Bayers

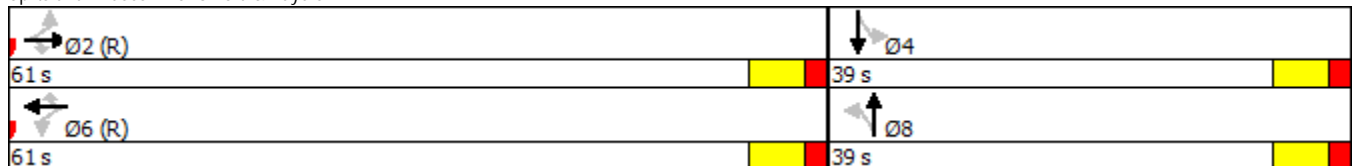

Lane Group	EBL	EBT	EBR	WBL	WBT	WBR	NBL	NBT	NBR	SBL	SBT
Lane Configurations											
Traffic Volume (vph)	90	410	50	140	420	150	120	455	140	60	190
Future Volume (vph)	90	410	50	140	420	150	120	455	140	60	190
Lane Group Flow (vph)	93	423	52	144	433	155	124	469	144	62	248
Turn Type	Perm	NA	Perm	pm+pt	NA	Perm	pm+pt	NA	Perm	Perm	NA
Protected Phases		2		1	6		3	8			4
Permitted Phases	2		2	6		6	8		8	4	
Detector Phase	2	2	2	1	6	6	3	8		4	4
Switch Phase											
Minimum Initial (s)	10.0	10.0	10.0	7.0	10.0	10.0	7.0	10.0	10.0	10.0	10.0
Minimum Split (s)	31.1	31.1	31.1	11.0	31.0	31.0	11.0	39.0	39.0	39.0	39.0
Total Split (s)	39.0	39.0	39.0	11.0	50.0	50.0	11.0	50.0	50.0	39.0	39.0
Total Split (%)	39.0%	39.0%	39.0%	11.0%	50.0%	50.0%	11.0%	50.0%	50.0%	39.0%	39.0%
Yellow Time (s)	4.1	4.1	4.1	4.0	4.0	4.0	4.0	4.1	4.1	4.1	4.1
All-Red Time (s)	3.0	3.0	3.0	0.0	3.0	3.0	0.0	2.9	2.9	2.9	2.9
Lost Time Adjust (s)	0.0	0.0	0.0	0.0	0.0	0.0	0.0	0.0	0.0	0.0	0.0
Total Lost Time (s)	7.1	7.1	7.1	4.0	7.0	7.0	4.0	7.0	7.0	7.0	7.0
Lead/Lag	Lag	Lag	Lag	Lead			Lead			Lag	Lag
Lead-Lag Optimize?											
Recall Mode	C-Max	C-Max	C-Max	None	C-Max	C-Max	None	Ped	Ped	Ped	Ped
Act Effct Green (s)	31.9	31.9	31.9	46.0	43.0	43.0	46.0	43.0	43.0	32.0	32.0
Actuated g/C Ratio	0.32	0.32	0.32	0.46	0.43	0.43	0.46	0.43	0.43	0.32	0.32
v/c Ratio	0.37	0.83	0.10	0.56	0.62	0.23	0.32	0.67	0.21	0.27	0.50
Control Delay	27.1	42.3	0.7	26.0	27.1	3.8	18.5	28.5	3.9	29.2	30.2
Queue Delay	0.0	0.0	0.0	0.0	0.0	0.0	0.0	0.0	0.0	0.0	0.0
Total Delay	27.1	42.3	0.7	26.0	27.1	3.8	18.5	28.5	3.9	29.2	30.2
LOS	C	D	A	C	C	A	B	C	A	C	C
Approach Delay		36.0			22.0			22.0			30.0
Approach LOS		D			C			C			C
Queue Length 50th (m)	9.5	77.7	0.0	16.2	63.7	0.0	13.7	70.8	0.0	8.9	36.4
Queue Length 95th (m)	20.5	#122.0	m0.4	28.6	95.8	11.0	24.9	106.0	10.6	20.0	59.9
Internal Link Dist (m)		309.1			142.1			493.5			927.7
Turn Bay Length (m)	50.0		80.0	40.0		80.0	90.0		50.0	40.0	
Base Capacity (vph)	253	507	503	255	694	679	386	704	672	232	494
Starvation Cap Reductn	0	0	0	0	0	0	0	0	0	0	0
Spillback Cap Reductn	0	0	0	0	0	0	0	0	0	0	0
Storage Cap Reductn	0	0	0	0	0	0	0	0	0	0	0
Reduced v/c Ratio	0.37	0.83	0.10	0.56	0.62	0.23	0.32	0.67	0.21	0.27	0.50

Intersection Summary





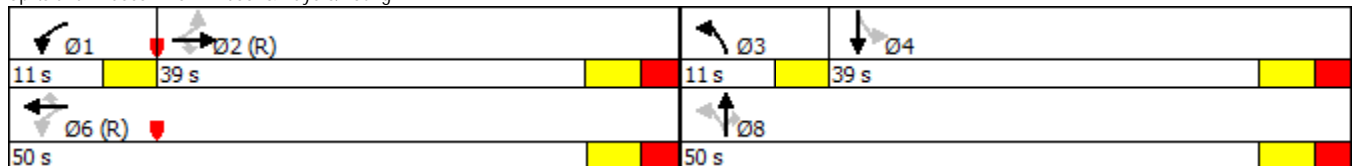





Cycle Length: 100
 Actuated Cycle Length: 100
 Offset: 77 (77%), Referenced to phase 2:EBTL and 6:WBTL, Start of Green
 Natural Cycle: 95
 Control Type: Actuated-Coordinated
 Maximum v/c Ratio: 0.83
 Intersection Signal Delay: 26.4
 Intersection Capacity Utilization 91.6%
 Analysis Period (min) 15
 # 95th percentile volume exceeds capacity, queue may be longer.
 Queue shown is maximum after two cycles.
 m Volume for 95th percentile queue is metered by upstream signal.

Splits and Phases: 6: Windsor & Bayers/Young



Halifax Transit Priority Corridors

7: Connaught & HSC

					
Lane Group	EBL	EBR	NBL	NBT	SBT
Lane Configurations					 
Traffic Volume (vph)	34	271	116	316	430
Future Volume (vph)	34	271	116	316	430
Lane Group Flow (vph)	38	301	129	351	582
Turn Type	Prot	Perm	Perm	NA	NA
Protected Phases	8			6	2
Permitted Phases		8	6		
Minimum Split (s)	24.0	24.0	24.0	24.0	24.0
Total Split (s)	49.0	49.0	61.0	61.0	61.0
Total Split (%)	44.5%	44.5%	55.5%	55.5%	55.5%
Yellow Time (s)	4.0	4.0	4.0	4.0	4.0
All-Red Time (s)	2.0	2.0	2.0	2.0	2.0
Lost Time Adjust (s)	0.0	0.0	0.0	0.0	0.0
Total Lost Time (s)	6.0	6.0	6.0	6.0	6.0
Lead/Lag					
Lead-Lag Optimize?					
Act Effct Green (s)	43.0	43.0	55.0	55.0	55.0
Actuated g/C Ratio	0.39	0.39	0.50	0.50	0.50
v/c Ratio	0.06	0.41	0.40	0.43	0.38
Control Delay	21.4	4.4	21.9	19.5	16.7
Queue Delay	0.0	0.0	0.0	1.6	0.0
Total Delay	21.4	4.4	21.9	21.1	16.7
LOS	C	A	C	C	B
Approach Delay	6.3			21.3	16.7
Approach LOS	A			C	B
Queue Length 50th (m)	5.0	0.0	16.7	46.1	36.6
Queue Length 95th (m)	11.7	16.4	32.7	68.9	49.4
Internal Link Dist (m)	287.5			104.0	1112.5
Turn Bay Length (m)	50.0				
Base Capacity (vph)	612	731	322	824	1540
Starvation Cap Reductn	0	0	0	302	0
Spillback Cap Reductn	0	0	0	0	0
Storage Cap Reductn	0	0	0	0	0
Reduced v/c Ratio	0.06	0.41	0.40	0.67	0.38

Intersection Summary

Cycle Length: 110
 Actuated Cycle Length: 110
 Offset: 0 (0%), Referenced to phase 2:SBT and 6:NBTL, Start of Green
 Natural Cycle: 50
 Control Type: Pretimed
 Maximum v/c Ratio: 0.43
 Intersection Signal Delay: 15.8
 Intersection Capacity Utilization 45.5%
 Analysis Period (min) 15





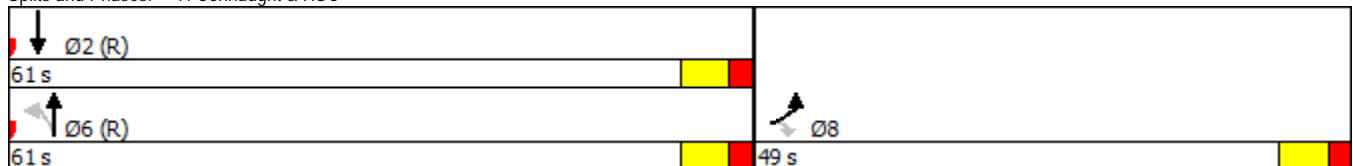





Intersection LOS: B
ICU Level of Service A

Splits and Phases: 7: Connaught & HSC



Halifax Transit Priority Corridors

2: HSC W & Bayers

						
Movement	EBT	EBR	WBL	WBT	NBL	NBR
Lane Configurations						
Traffic Volume (veh/h)	1030	150	0	2125	0	221
Future Volume (Veh/h)	1030	150	0	2125	0	221
Sign Control	Free			Free	Stop	
Grade	0%			0%	0%	
Peak Hour Factor	0.90	0.90	0.90	0.90	0.90	0.90
Hourly flow rate (vph)	1144	167	0	2361	0	246
Pedestrians						
Lane Width (m)						
Walking Speed (m/s)						
Percent Blockage						
Right turn flare (veh)						
Median type	None			None		
Median storage (veh)						
Upstream signal (m)				182		
pX, platoon unblocked					0.73	
vC, conflicting volume			1311		2324	572
vC1, stage 1 conf vol						
vC2, stage 2 conf vol						
vCu, unblocked vol			1311		2078	572
IC, single (s)			4.1		6.8	6.9
IC, 2 stage (s)						
IF (s)			2.2		3.5	3.3
p0 queue free %			100		100	47
cM capacity (veh/h)			524		34	463
Direction, Lane #	EB 1	EB 2	EB 3	WB 1	WB 2	NB 1
Volume Total	572	572	167	1180	1180	246
Volume Left	0	0	0	0	0	0
Volume Right	0	0	167	0	0	246
cSH	1700	1700	1700	1700	1700	463
Volume to Capacity	0.34	0.34	0.10	0.69	0.69	0.53
Queue Length 95th (m)	0.0	0.0	0.0	0.0	0.0	23.2
Control Delay (s)	0.0	0.0	0.0	0.0	0.0	21.2
Lane LOS						C
Approach Delay (s)	0.0			0.0		21.2
Approach LOS						C
Intersection Summary						
Average Delay			1.3			
Intersection Capacity Utilization			69.0%		ICU Level of Service	C
Analysis Period (min)			15			

Halifax Transit Priority Corridors

1: Romans & Bayers

Lane Group	EBL	EBT	EBR	WBL	WBT	WBR	NBL	NBT	NBR	SBL	SBT	SBR
Lane Configurations												
Traffic Volume (vph)	5	1785	85	0	850	5	60	60	5	20	35	40
Future Volume (vph)	5	1785	85	0	850	5	60	60	5	20	35	40
Satd. Flow (prot)	0	3031	1387	0	3096	0	1498	1544	0	0	1479	0
Fit Permitted		0.953					0.696				0.932	
Satd. Flow (perm)	0	2889	1247	0	3096	0	1045	1544	0	0	1358	0
Satd. Flow (RTOR)			80		1			3			30	
Lane Group Flow (vph)	0	1884	89	0	900	0	63	68	0	0	100	0
Turn Type	Perm	NA	Perm		NA		Perm	NA		Perm	NA	
Protected Phases		2			2			4			4	
Permitted Phases	2		2				4			4		
Total Split (s)	80.0	80.0	80.0		80.0		30.0	30.0		30.0	30.0	
Total Lost Time (s)		5.8	5.8		5.8		6.1	6.1			6.1	
Act Effct Green (s)		75.1	75.1		75.1		23.0	23.0			23.0	
Actuated g/C Ratio		0.68	0.68		0.68		0.21	0.21			0.21	
v/c Ratio		0.96	0.10		0.43		0.29	0.21			0.33	
Control Delay		29.0	1.9		4.8		40.9	36.4			29.2	
Queue Delay		0.0	0.0		0.0		0.0	0.0			0.0	
Total Delay		29.0	1.9		4.8		40.9	36.4			29.2	
LOS		C	A		A		D	D			C	
Approach Delay		27.8			4.8			38.6			29.2	
Approach LOS		C			A			D			C	
Queue Length 50th (m)		174.2	0.6		22.0		11.5	11.6			12.6	
Queue Length 95th (m)		#253.7	5.2		47.6		24.1	23.9			28.0	
Internal Link Dist (m)		76.6			386.3			826.4			535.1	
Turn Bay Length (m)			60.0				40.0					
Base Capacity (vph)		1972	876		2114		227	337			318	
Starvation Cap Reductn		0	0		0		0	0			0	
Spillback Cap Reductn		0	0		0		0	0			0	
Storage Cap Reductn		0	0		0		0	0			0	
Reduced v/c Ratio		0.96	0.10		0.43		0.28	0.20			0.31	

Intersection Summary

Cycle Length: 110

Actuated Cycle Length: 110

Offset: 8 (7%), Referenced to phase 2:EBWB and 6:, Start of Green

Control Type: Actuated-Coordinated

Maximum v/c Ratio: 0.96

Intersection Signal Delay: 21.6

Intersection LOS: C

Intersection Capacity Utilization 88.1%

ICU Level of Service E

Analysis Period (min) 15

95th percentile volume exceeds capacity, queue may be longer.

Queue shown is maximum after two cycles.

Splits and Phases: 1: Romans & Bayers



	→	↘	↙	←	↖	↗
Lane Group	EBT	EBR	WBL	WBT	NBL	NBR
Lane Configurations	↑↑	↑		↑↑	↑↘	
Traffic Volume (vph)	1800	25	0	795	35	0
Future Volume (vph)	1800	25	0	795	35	0
Satd. Flow (prot)	3131	1401	0	3131	3038	0
Fit Permitted					0.950	
Satd. Flow (perm)	3131	1401	0	3131	3038	0
Satd. Flow (RTOR)		10				
Lane Group Flow (vph)	2000	28	0	883	39	0
Turn Type	NA	Perm		NA	Prot	
Protected Phases	2			6	8	
Permitted Phases		2				
Total Split (s)	75.0	75.0		75.0	35.0	
Total Lost Time (s)	7.9	7.9		7.9	6.0	
Act Effct Green (s)	67.1	67.1		67.1	29.0	
Actuated g/C Ratio	0.61	0.61		0.61	0.26	
v/c Ratio	1.05	0.03		0.46	0.05	
Control Delay	40.0	3.4		2.5	30.5	
Queue Delay	11.8	0.0		0.1	0.0	
Total Delay	51.8	3.4		2.6	30.5	
LOS	D	A		A	C	
Approach Delay	51.2			2.6	30.5	
Approach LOS	D			A	C	
Queue Length 50th (m)	-242.5	0.2		2.9	3.2	
Queue Length 95th (m)	m#267.1	m0.4		11.4	7.4	
Internal Link Dist (m)	386.3			15.6	295.6	
Turn Bay Length (m)		25.0				
Base Capacity (vph)	1909	858		1909	800	
Starvation Cap Reductn	0	0		204	0	
Spillback Cap Reductn	52	0		0	0	
Storage Cap Reductn	0	0		0	0	
Reduced v/c Ratio	1.08	0.03		0.52	0.05	

Intersection Summary

Cycle Length: 110
 Actuated Cycle Length: 110
 Offset: 34 (31%), Referenced to phase 2:EBT and 6:WBT, Start of Green
 Control Type: Actuated-Coordinated
 Maximum v/c Ratio: 1.05
 Intersection Signal Delay: 36.3
 Intersection Capacity Utilization 73.0%
 Analysis Period (min) 15
 ~ Volume exceeds capacity, queue is theoretically infinite.
 Queue shown is maximum after two cycles.
 # 95th percentile volume exceeds capacity, queue may be longer.
 Queue shown is maximum after two cycles.
 m Volume for 95th percentile queue is metered by upstream signal.

Splits and Phases: 2: HSC W & Bayers

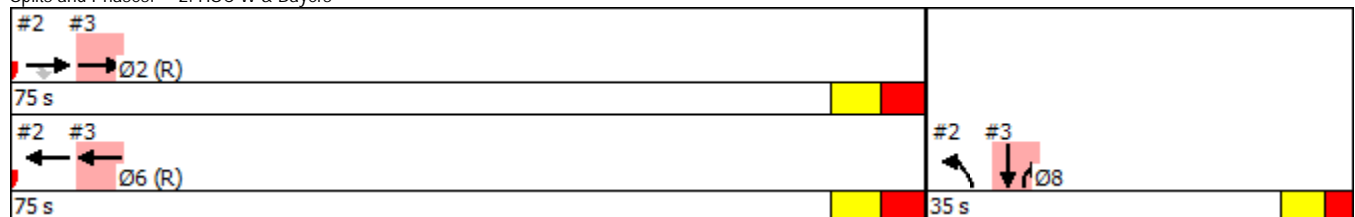

Lane Group	EBL	EBT	EBR	WBL	WBT	WBR	NBL	NBT	NBR	SBL	SBT	SBR
Lane Configurations												
Traffic Volume (vph)	0	1775	25	0	795	0	0	0	150	0	220	0
Future Volume (vph)	0	1775	25	0	795	0	0	0	150	0	220	0
Satd. Flow (prot)	0	3088	0	0	3101	0	0	0	2442	0	3131	0
Flt Permitted												
Satd. Flow (perm)	0	3088	0	0	3101	0	0	0	2442	0	3131	0
Satd. Flow (RTOR)		2							49			
Lane Group Flow (vph)	0	1875	0	0	828	0	0	0	156	0	244	0
Turn Type		NA			NA				Prot		NA	
Protected Phases		2			6				8		8	
Permitted Phases												
Total Split (s)		75.0			75.0				35.0		35.0	
Total Lost Time (s)		7.9			7.9				6.0		6.0	
Act Effct Green (s)		67.1			67.1				29.0		29.0	
Actuated g/C Ratio		0.61			0.61				0.26		0.26	
v/c Ratio		1.00			0.44				0.23		0.30	
Control Delay		9.5			10.2				22.6		33.5	
Queue Delay		18.2			0.2				0.0		0.0	
Total Delay		27.7			10.3				22.6		33.5	
LOS		C			B				C		C	
Approach Delay		27.7			10.3			22.6			33.5	
Approach LOS		C			B			C			C	
Queue Length 50th (m)		0.0			44.5				10.0		22.0	
Queue Length 95th (m)		m0.0			52.7				19.4		33.0	
Internal Link Dist (m)		15.6			119.7			310.7			66.8	
Turn Bay Length (m)												
Base Capacity (vph)		1884			1891				679		825	
Starvation Cap Reductn		85			330				0		0	
Spillback Cap Reductn		102			6				1		0	
Storage Cap Reductn		0			0				0		0	
Reduced v/c Ratio		1.05			0.53				0.23		0.30	

Intersection Summary

Cycle Length: 110
 Actuated Cycle Length: 110
 Offset: 34 (31%), Referenced to phase 2:EBT and 6:WBT, Start of Green
 Control Type: Actuated-Coordinated
 Maximum v/c Ratio: 1.05
 Intersection Signal Delay: 23.3
 Intersection Capacity Utilization 74.2%
 Analysis Period (min) 15
 m Volume for 95th percentile queue is metered by upstream signal.

Intersection LOS: C
 ICU Level of Service D

Splits and Phases: 3: HSC E & Bayers

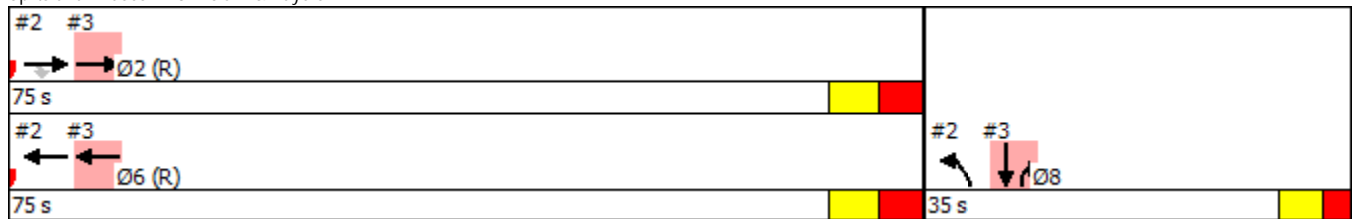

Lane Group	EBL	EBT	EBR	WBL	WBT	WBR	NBL	NBT	NBR	SBL	SBT	SBR
Lane Configurations												
Traffic Volume (vph)	325	700	900	0	481	109	162	303	90	0	185	152
Future Volume (vph)	325	700	900	0	481	109	162	303	90	0	185	152
Satd. Flow (prot)	1551	1632	1387	0	2959	1387	3008	1550	0	0	3039	2393
Fit Permitted	0.352						0.950					
Satd. Flow (perm)	569	1632	1326	0	2959	1342	3008	1550	0	0	3039	2393
Satd. Flow (RTOR)			567			151		16				
Lane Group Flow (vph)	339	729	938	0	501	114	169	410	0	0	193	158
Turn Type	pm+pt	NA	Perm		NA	Perm	Prot	NA			NA	pt+ov
Protected Phases	5	2			6		3	8			4	4 5
Permitted Phases	2		2			6						
Total Split (s)	17.0	61.0	61.0		44.0	44.0	18.0	49.0			31.0	
Total Lost Time (s)	4.0	5.9	5.9		5.9	6.9	6.0	5.2			5.2	
Act Effct Green (s)	57.6	55.7	55.7		38.1	37.1	12.0	43.2			25.2	42.8
Actuated g/C Ratio	0.52	0.51	0.51		0.35	0.34	0.11	0.39			0.23	0.39
v/c Ratio	0.81	0.88	0.99		0.49	0.21	0.52	0.66			0.28	0.17
Control Delay	14.2	15.8	25.3		26.5	3.6	52.3	32.6			36.2	22.6
Queue Delay	0.0	14.1	34.2		0.0	0.0	0.0	0.0			0.0	0.0
Total Delay	14.2	29.9	59.6		26.5	3.6	52.3	32.6			36.2	22.6
LOS	B	C	E		C	A	D	C			D	C
Approach Delay		41.1			22.2			38.3			30.1	
Approach LOS		D			C			D			C	
Queue Length 50th (m)	12.8	73.1	200.7		38.3	0.7	17.9	68.8			18.1	12.4
Queue Length 95th (m)	m15.4	m86.4	m#205.7		62.5	4.5	28.7	102.2			28.1	20.2
Internal Link Dist (m)		119.7			156.1			461.8			84.0	
Turn Bay Length (m)	90.0					60.0	110.0					35.0
Base Capacity (vph)	420	827	951		1024	552	328	626			712	854
Starvation Cap Reductn	0	99	91		0	0	0	0			0	0
Spillback Cap Reductn	0	0	0		0	0	0	0			0	0
Storage Cap Reductn	0	0	0		0	0	0	0			0	0
Reduced v/c Ratio	0.81	1.00	1.09		0.49	0.21	0.52	0.65			0.27	0.19

Intersection Summary

Cycle Length: 110
 Actuated Cycle Length: 110
 Offset: 70 (64%), Referenced to phase 2:EBTL and 6:WBT, Start of Green
 Control Type: Actuated-Coordinated
 Maximum v/c Ratio: 0.99
 Intersection Signal Delay: 36.3
 Intersection Capacity Utilization 94.7%
 Analysis Period (min) 15
 # 95th percentile volume exceeds capacity, queue may be longer.
 Queue shown is maximum after two cycles.
 m Volume for 95th percentile queue is metered by upstream signal.

Intersection LOS: D
 ICU Level of Service F

Splits and Phases: 4: Connaught & Bayers

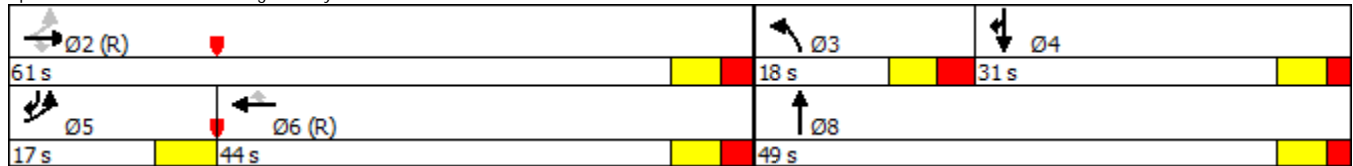

Lane Group	EBL	EBT	EBR	WBL	WBT	WBR	NBL	NBT	NBR	SBL	SBT	SBR
Lane Configurations												
Traffic Volume (vph)	0	501	206	19	304	28	99	103	36	22	103	1
Future Volume (vph)	0	501	206	19	304	28	99	103	36	22	103	1
Satd. Flow (prot)	0	1419	1085	0	1575	1374	1449	1485	0	1420	1344	0
Fit Permitted					0.960		0.685			0.573		
Satd. Flow (perm)	0	1419	1033	0	1516	1304	1018	1485	0	783	1344	0
Satd. Flow (RTOR)			215			29		15				
Lane Group Flow (vph)	0	522	215	0	337	29	103	145	0	23	108	0
Turn Type		NA	Perm	Perm	NA	Perm	Perm	NA		Perm	NA	
Protected Phases		2			6			8			4	
Permitted Phases	2		2	6		6	8			4		
Total Split (s)	78.0	78.0	78.0	78.0	78.0	78.0	32.0	32.0		32.0	32.0	
Total Lost Time (s)		5.9	5.9		5.9	5.9	5.9	5.9		5.9	5.9	
Act Effct Green (s)		81.6	81.6		81.6	81.6	16.6	16.6		16.6	16.6	
Actuated g/C Ratio		0.74	0.74		0.74	0.74	0.15	0.15		0.15	0.15	
v/c Ratio		0.50	0.26		0.30	0.03	0.67	0.61		0.19	0.53	
Control Delay		2.6	0.4		4.7	0.7	63.9	49.1		42.0	51.4	
Queue Delay		0.0	0.0		0.0	0.0	0.0	0.0		0.0	0.0	
Total Delay		2.6	0.4		4.7	0.7	63.9	49.1		42.0	51.4	
LOS		A	A		A	A	E	D		D	D	
Approach Delay		2.0			4.4			55.3			49.8	
Approach LOS		A			A			E			D	
Queue Length 50th (m)		11.1	0.0		12.6	0.0	21.2	26.5		4.4	21.7	
Queue Length 95th (m)		m13.9	m0.0		m27.1	m0.8	36.7	43.2		11.2	36.2	
Internal Link Dist (m)		259.6			309.1			518.4			229.7	
Turn Bay Length (m)			60.0			60.0	65.0			60.0		
Base Capacity (vph)		1052	821		1124	974	241	363		185	318	
Starvation Cap Reductn		0	0		0	0	0	0		0	0	
Spillback Cap Reductn		0	0		0	0	0	0		0	0	
Storage Cap Reductn		0	0		0	0	0	0		0	0	
Reduced v/c Ratio		0.50	0.26		0.30	0.03	0.43	0.40		0.12	0.34	

Intersection Summary

Cycle Length: 110
 Actuated Cycle Length: 110
 Offset: 76 (69%), Referenced to phase 2:EBTL and 6:WBTL, Start of Green
 Control Type: Actuated-Coordinated
 Maximum v/c Ratio: 0.67
 Intersection Signal Delay: 15.7
 Intersection Capacity Utilization 73.3%
 Analysis Period (min) 15
 m Volume for 95th percentile queue is metered by upstream signal.

Intersection LOS: B
 ICU Level of Service D

Splits and Phases: 5: Oxford & Bayers

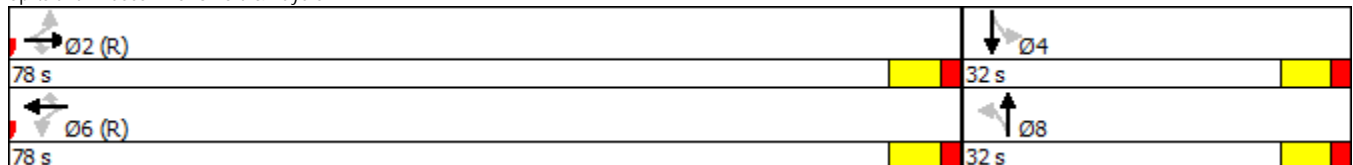

Lane Group	EBL	EBT	EBR	WBL	WBT	WBR	NBL	NBT	NBR	SBL	SBT	SBR
Lane Configurations												
Traffic Volume (vph)	52	457	79	53	243	99	76	180	151	108	436	42
Future Volume (vph)	52	457	79	53	243	99	76	180	151	108	436	42
Satd. Flow (prot)	1451	1528	0	1422	2884	0	1458	1607	1382	1473	1530	0
Fit Permitted	0.533			0.180			0.344			0.522		
Satd. Flow (perm)	814	1528	0	269	2884	0	528	1607	1350	803	1530	0
Satd. Flow (RTOR)		9			77				162		5	
Lane Group Flow (vph)	56	576	0	57	367	0	82	194	162	116	514	0
Turn Type	Perm	NA		pm+pt	NA		Perm	NA	Perm	pm+pt	NA	
Protected Phases		2		1	6			8		7	4	
Permitted Phases	2			6			8		8	4		
Total Split (s)	49.0	49.0		11.0	60.0		39.0	39.0	39.0	11.0	50.0	
Total Lost Time (s)	7.1	7.1		4.0	7.0		7.0	7.0	7.0	4.0	7.0	
Act Effct Green (s)	44.1	44.1		56.0	53.0		32.0	32.0	32.0	46.0	43.0	
Actuated g/C Ratio	0.40	0.40		0.51	0.48		0.29	0.29	0.29	0.42	0.39	
v/c Ratio	0.17	0.93		0.27	0.26		0.54	0.42	0.32	0.31	0.86	
Control Delay	12.7	42.6		17.2	13.6		47.7	34.8	6.4	22.8	45.9	
Queue Delay	0.0	0.0		0.0	0.0		0.0	0.0	0.0	0.0	0.0	
Total Delay	12.7	42.6		17.2	13.6		47.7	34.8	6.4	22.8	45.9	
LOS	B	D		B	B		D	C	A	C	D	
Approach Delay		40.0			14.1			26.7			41.7	
Approach LOS		D			B			C			D	
Queue Length 50th (m)	5.1	115.8		6.0	18.3		14.8	33.6	0.0	15.4	98.6	
Queue Length 95th (m)	m11.1	#189.4		12.7	27.7		31.8	54.5	15.0	27.5	#158.0	
Internal Link Dist (m)		309.1			142.1			569.0			312.0	
Turn Bay Length (m)	50.0			40.0			90.0		50.0	40.0		
Base Capacity (vph)	326	617		210	1429		153	467	507	378	601	
Starvation Cap Reductn	0	0		0	0		0	0	0	0	0	
Spillback Cap Reductn	0	0		0	0		0	0	0	0	0	
Storage Cap Reductn	0	0		0	0		0	0	0	0	0	
Reduced v/c Ratio	0.17	0.93		0.27	0.26		0.54	0.42	0.32	0.31	0.86	

Intersection Summary

Cycle Length: 110
 Actuated Cycle Length: 110
 Offset: 14 (13%), Referenced to phase 2:EBTL and 6:WBT, Start of Green
 Control Type: Actuated-Coordinated
 Maximum v/c Ratio: 0.93
 Intersection Signal Delay: 32.6
 Intersection Capacity Utilization 95.8%
 Analysis Period (min) 15
 # 95th percentile volume exceeds capacity, queue may be longer.
 Queue shown is maximum after two cycles.
 m Volume for 95th percentile queue is metered by upstream signal.

Splits and Phases: 6: Windsor & Bayers/Young

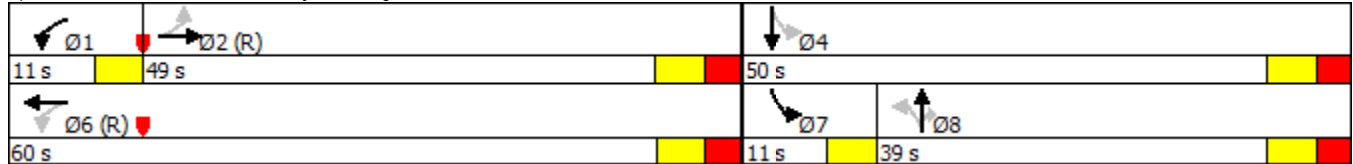

Lane Group	EBT	EBR	WBT	WBR	NBL2	NBT	SBL	SBT
Lane Configurations								
Traffic Volume (vph)	1495	115	2110	15	120	75	5	30
Future Volume (vph)	1495	115	2110	15	120	75	5	30
Lane Group Flow (vph)	1510	116	2131	22	121	91	0	308
Turn Type	NA	Perm	NA	Perm	Perm	NA	Perm	NA
Protected Phases	2		2			4		4
Permitted Phases		2		2	4		4	
Detector Phase	2	2	2	2	4	4	4	4
Switch Phase								
Minimum Initial (s)	10.0	10.0	10.0	10.0	10.0	10.0	10.0	10.0
Minimum Split (s)	23.8	23.8	23.8	23.8	29.1	29.1	29.1	29.1
Total Split (s)	94.0	94.0	94.0	94.0	36.0	36.0	36.0	36.0
Total Split (%)	72.3%	72.3%	72.3%	72.3%	27.7%	27.7%	27.7%	27.7%
Yellow Time (s)	4.1	4.1	4.1	4.1	4.1	4.1	4.1	4.1
All-Red Time (s)	1.7	1.7	1.7	1.7	2.0	2.0	2.0	2.0
Lost Time Adjust (s)	0.0	0.0	0.0	0.0	0.0	0.0	0.0	0.0
Total Lost Time (s)	5.8	5.8	5.8	5.8	6.1	6.1		6.1
Lead/Lag								
Lead-Lag Optimize?								
Recall Mode	C-Min	C-Min	C-Min	C-Min	Ped	Ped	Ped	Ped
Act Effct Green (s)	88.2	88.2	88.2	88.2	29.9	29.9		29.9
Actuated g/C Ratio	0.68	0.68	0.68	0.68	0.23	0.23		0.23
v/c Ratio	0.73	0.13	1.00	0.03	1.10	0.25		1.01
Control Delay	15.9	1.6	29.6	1.1	161.9	40.0		102.9
Queue Delay	0.0	0.0	0.0	0.0	0.0	0.0		0.0
Total Delay	15.9	1.6	29.6	1.1	161.9	40.0		102.9
LOS	B	A	C	A	F	D		F
Approach Delay	14.9		29.3			109.6		102.9
Approach LOS	B		C			F		F
Queue Length 50th (m)	118.6	0.0	-211.7	0.1	-35.0	17.7		-80.0
Queue Length 95th (m)	144.4	5.8	#344.1	m0.0	#73.9	33.1		#138.7
Internal Link Dist (m)	1417.0		385.8			886.2		555.5
Turn Bay Length (m)					40.0			
Base Capacity (vph)	2076	877	2124	775	110	357		306
Starvation Cap Reductn	0	0	0	0	0	0		0
Spillback Cap Reductn	0	0	0	0	0	0		0
Storage Cap Reductn	0	0	0	0	0	0		0
Reduced v/c Ratio	0.73	0.13	1.00	0.03	1.10	0.25		1.01

Intersection Summary

Cycle Length: 130
 Actuated Cycle Length: 130
 Offset: 57 (44%), Referenced to phase 2:EBWB and 6:, Start of Green
 Natural Cycle: 120
 Control Type: Actuated-Coordinated
 Maximum v/c Ratio: 1.10
 Intersection Signal Delay: 33.1
 Intersection Capacity Utilization 123.3%
 Analysis Period (min) 15
 ~ Volume exceeds capacity, queue is theoretically infinite.
 Queue shown is maximum after two cycles.
 # 95th percentile volume exceeds capacity, queue may be longer.
 Queue shown is maximum after two cycles.
 m Volume for 95th percentile queue is metered by upstream signal.

Splits and Phases: 1: Romans & Bayers



	→	↘	←	↙
Lane Group	EBT	EBR	WBT	NBL
Lane Configurations	↑↑	↑	↑↑	↑↑
Traffic Volume (vph)	1095	85	1760	365
Future Volume (vph)	1095	85	1760	365
Lane Group Flow (vph)	1217	94	1956	406
Turn Type	NA	Perm	NA	Prot
Protected Phases	2		6	8
Permitted Phases		2		
Detector Phase	2	2	6	8
Switch Phase				
Minimum Initial (s)	10.0	10.0	10.0	7.0
Minimum Split (s)	27.9	27.9	27.9	35.0
Total Split (s)	94.0	94.0	94.0	36.0
Total Split (%)	72.3%	72.3%	72.3%	27.7%
Yellow Time (s)	4.1	4.1	4.1	3.5
All-Red Time (s)	3.8	3.8	3.8	2.5
Lost Time Adjust (s)	0.0	0.0	0.0	0.0
Total Lost Time (s)	7.9	7.9	7.9	6.0
Lead/Lag				
Lead-Lag Optimize?				
Recall Mode	C-Min	C-Min	C-Min	Min
Act Effct Green (s)	91.3	91.3	91.3	24.8
Actuated g/C Ratio	0.70	0.70	0.70	0.19
v/c Ratio	0.55	0.09	0.89	0.70
Control Delay	16.7	8.0	7.0	55.6
Queue Delay	0.0	0.0	0.1	0.0
Total Delay	16.7	8.0	7.1	55.6
LOS	B	A	A	E
Approach Delay	16.1		7.1	55.6
Approach LOS	B		A	E
Queue Length 50th (m)	99.9	5.7	13.3	50.4
Queue Length 95th (m)	124.8	m12.9	#20.3	64.4
Internal Link Dist (m)	385.8		14.6	462.4
Turn Bay Length (m)		25.0		
Base Capacity (vph)	2199	999	2199	701
Starvation Cap Reductn	0	0	12	0
Spillback Cap Reductn	0	0	0	0
Storage Cap Reductn	0	0	0	0
Reduced v/c Ratio	0.55	0.09	0.89	0.58

Intersection Summary

Cycle Length: 130
 Actuated Cycle Length: 130
 Offset: 28 (22%), Referenced to phase 2:EBT and 6:WBT, Start of Green
 Natural Cycle: 110
 Control Type: Actuated-Coordinated
 Maximum v/c Ratio: 0.89
 Intersection Signal Delay: 15.6
 Intersection Capacity Utilization 77.6%
 Analysis Period (min) 15
 # 95th percentile volume exceeds capacity, queue may be longer.
 Queue shown is maximum after two cycles.
 m Volume for 95th percentile queue is metered by upstream signal.

Intersection LOS: B
 ICU Level of Service D

Splits and Phases: 2: HSC W & Bayers

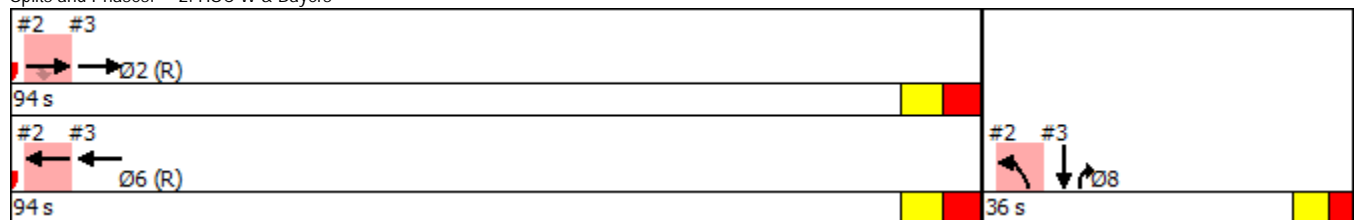

	→	←	↗	↓
Lane Group	EBT	WBT	NBR	SBT
Lane Configurations	↑↑	↑↑	↑↑	↑↑
Traffic Volume (vph)	1030	1760	255	210
Future Volume (vph)	1030	1760	255	210
Lane Group Flow (vph)	1141	1833	266	233
Turn Type	NA	NA	Prot	NA
Protected Phases	2	6	8	8
Permitted Phases				
Detector Phase	2	6	8	8
Switch Phase				
Minimum Initial (s)	10.0	10.0	7.0	7.0
Minimum Split (s)	27.9	27.9	35.0	35.0
Total Split (s)	94.0	94.0	36.0	36.0
Total Split (%)	72.3%	72.3%	27.7%	27.7%
Yellow Time (s)	4.1	4.1	3.5	3.5
All-Red Time (s)	3.8	3.8	2.5	2.5
Lost Time Adjust (s)	0.0	0.0	0.0	0.0
Total Lost Time (s)	7.9	7.9	6.0	6.0
Lead/Lag				
Lead-Lag Optimize?				
Recall Mode	C-Min	C-Min	Min	Min
Act Effct Green (s)	91.3	91.3	24.8	24.8
Actuated g/C Ratio	0.70	0.70	0.19	0.19
v/c Ratio	0.53	0.84	0.43	0.39
Control Delay	2.4	6.5	15.1	50.6
Queue Delay	0.0	2.0	0.1	0.0
Total Delay	2.4	8.5	15.2	50.6
LOS	A	A	B	D
Approach Delay	2.4	8.5		50.6
Approach LOS	A	A		D
Queue Length 50th (m)	0.0	28.0	9.0	29.0
Queue Length 95th (m)	0.0	m30.5	21.4	m37.8
Internal Link Dist (m)	14.6	119.7		121.4
Turn Bay Length (m)				
Base Capacity (vph)	2150	2178	711	722
Starvation Cap Reductn	90	205	0	0
Spillback Cap Reductn	19	14	71	0
Storage Cap Reductn	0	0	0	0
Reduced v/c Ratio	0.55	0.93	0.42	0.32

Intersection Summary

Cycle Length: 130
 Actuated Cycle Length: 130
 Offset: 28 (22%), Referenced to phase 2:EBT and 6:WBT, Start of Green
 Natural Cycle: 110
 Control Type: Actuated-Coordinated
 Maximum v/c Ratio: 0.89
 Intersection Signal Delay: 9.8
 Intersection Capacity Utilization 72.4%
 Analysis Period (min) 15
 m Volume for 95th percentile queue is metered by upstream signal.

Intersection LOS: A
 ICU Level of Service C

Splits and Phases: 3: HSC E & Bayers

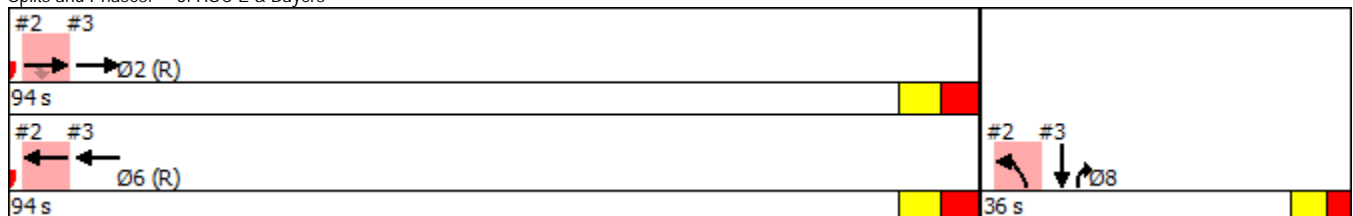

Halifax Transit Priority Corridors

4: Connaught & Bayers

Lane Group	EBL	EBT	EBR	WBT	WBR	NBL	NBT	SBT	SBR
Lane Configurations									
Traffic Volume (vph)	195	515	575	820	90	744	181	130	196
Future Volume (vph)	195	515	575	820	90	744	181	130	196
Lane Group Flow (vph)	203	536	599	854	94	775	225	135	204
Turn Type	pm+pt	NA	Perm	NA	Perm	Prot	NA	NA	pm+ov
Protected Phases	5	2		6		3	8	4	5
Permitted Phases	2		2		6				4
Detector Phase	5	2	2	6	6	3	8	4	4.5
Switch Phase									
Minimum Initial (s)	7.0	10.0	10.0	10.0	10.0	7.0	10.0	10.0	7.0
Minimum Split (s)	12.0	42.9	42.9	42.9	42.9	14.0	30.2	30.2	12.0
Total Split (s)	15.0	59.0	59.0	44.0	44.0	40.0	71.0	31.0	15.0
Total Split (%)	11.5%	45.4%	45.4%	33.8%	33.8%	30.8%	54.6%	23.8%	11.5%
Yellow Time (s)	5.0	4.1	4.1	4.1	4.1	4.0	4.1	4.1	5.0
All-Red Time (s)	0.0	2.8	2.8	2.8	2.8	3.0	2.1	2.1	0.0
Lost Time Adjust (s)	-1.0	-1.0	-1.0	-1.0	0.0	-1.0	-1.0	-1.0	-1.0
Total Lost Time (s)	4.0	5.9	5.9	5.9	6.9	6.0	5.2	5.2	4.0
Lead/Lag	Lead			Lag	Lag	Lead		Lag	Lead
Lead-Lag Optimize?									
Recall Mode	Max	C-Max	C-Max	C-Max	C-Max	Max	Ped	Ped	Max
Act Effect Green (s)	55.8	53.9	53.9	38.1	37.1	34.0	65.0	25.0	38.0
Actuated g/C Ratio	0.43	0.41	0.41	0.29	0.29	0.26	0.50	0.19	0.29
v/c Ratio	1.03	0.79	0.68	0.99	0.20	0.99	0.28	0.23	0.30
Control Delay	109.2	33.4	9.6	74.0	3.2	76.6	19.1	45.6	34.3
Queue Delay	0.0	2.6	0.2	19.8	0.0	0.0	0.0	0.0	0.0
Total Delay	109.2	36.0	9.8	93.7	3.2	76.6	19.1	45.6	34.3
LOS	F	D	A	F	A	E	B	D	C
Approach Delay		35.4		84.8			63.7	38.8	
Approach LOS		D		F			E	D	
Queue Length 50th (m)	~43.7	70.6	25.9	114.7	0.0	102.2	31.0	15.5	21.9
Queue Length 95th (m)	#89.9	117.9	31.4	#158.0	6.0	#142.8	48.2	25.1	33.1
Internal Link Dist (m)		119.7		129.2			1920.3	104.0	
Turn Bay Length (m)	90.0				60.0	110.0			35.0
Base Capacity (vph)	198	676	883	863	470	786	802	603	688
Starvation Cap Reductn	0	63	30	0	0	0	0	0	0
Spillback Cap Reductn	0	0	0	54	0	0	0	0	0
Storage Cap Reductn	0	0	0	0	0	0	0	0	0
Reduced v/c Ratio	1.03	0.87	0.70	1.06	0.20	0.99	0.28	0.22	0.30

Intersection Summary

Cycle Length: 130
 Actuated Cycle Length: 130
 Offset: 26 (20%), Referenced to phase 2:EBTL and 6:WBT, Start of Green
 Natural Cycle: 120
 Control Type: Actuated-Coordinated
 Maximum v/c Ratio: 1.03
 Intersection Signal Delay: 56.4
 Intersection Capacity Utilization 102.7%
 Analysis Period (min) 15

~ Volume exceeds capacity, queue is theoretically infinite.
 Queue shown is maximum after two cycles.

95th percentile volume exceeds capacity, queue may be longer.
 Queue shown is maximum after two cycles.

Splits and Phases: 4: Connaught & Bayers

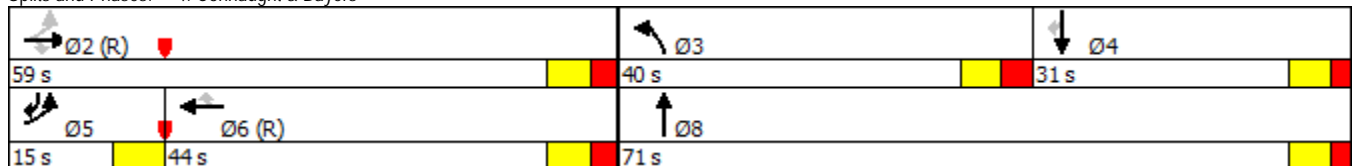

Halifax Transit Priority Corridors

5: Oxford & Bayers

Lane Group	EBL	EBT	EBR	WBL	WBT	WBR	NBL	NBT	SBL	SBT
Lane Configurations										
Traffic Volume (vph)	10	395	75	20	640	185	135	240	20	55
Future Volume (vph)	10	395	75	20	640	185	135	240	20	55
Lane Group Flow (vph)	0	409	76	0	666	187	136	282	20	61
Turn Type	Perm	NA	Perm	Perm	NA	Perm	Perm	NA	Perm	NA
Protected Phases		2			6			8		4
Permitted Phases	2		2	6		6	8		4	
Detector Phase	2	2	2	6	6	6	8	8	4	4
Switch Phase										
Minimum Initial (s)	10.0	10.0	10.0	10.0	10.0	10.0	10.0	10.0	10.0	10.0
Minimum Split (s)	24.9	24.9	24.9	24.9	24.9	24.9	23.9	23.9	23.9	23.9
Total Split (s)	61.0	61.0	61.0	61.0	61.0	61.0	39.0	39.0	39.0	39.0
Total Split (%)	61.0%	61.0%	61.0%	61.0%	61.0%	61.0%	39.0%	39.0%	39.0%	39.0%
Yellow Time (s)	4.1	4.1	4.1	4.1	4.1	4.1	4.1	4.1	4.1	4.1
All-Red Time (s)	1.8	1.8	1.8	1.8	1.8	1.8	1.8	1.8	1.8	1.8
Lost Time Adjust (s)		0.0	0.0		0.0	0.0	0.0	0.0	0.0	0.0
Total Lost Time (s)		5.9	5.9		5.9	5.9	5.9	5.9	5.9	5.9
Lead/Lag										
Lead-Lag Optimize?										
Recall Mode	C-Max	C-Max	C-Max	C-Max	C-Max	C-Max	None	None	None	None
Act Effct Green (s)		64.9	64.9		64.9	64.9	23.3	23.3	23.3	23.3
Actuated g/C Ratio		0.65	0.65		0.65	0.65	0.23	0.23	0.23	0.23
v/c Ratio		0.45	0.11		0.66	0.20	0.56	0.77	0.16	0.20
Control Delay		12.0	2.7		11.9	1.5	41.2	47.8	30.4	27.6
Queue Delay		0.0	0.0		0.0	0.0	0.0	0.0	0.0	0.0
Total Delay		12.0	2.7		11.9	1.5	41.2	47.8	30.4	27.6
LOS		B	A		B	A	D	D	C	C
Approach Delay		10.5			9.6			45.7		28.3
Approach LOS		B			A			D		C
Queue Length 50th (m)		35.4	0.0		49.9	0.0	23.4	49.8	3.1	8.8
Queue Length 95th (m)		71.1	6.0		82.6	4.8	37.9	70.0	8.6	17.2
Internal Link Dist (m)		286.5			309.1			439.9		191.0
Turn Bay Length (m)			60.0			60.0	65.0		60.0	
Base Capacity (vph)		913	678		1006	920	348	518	180	441
Starvation Cap Reductn		0	0		0	0	0	0	0	0
Spillback Cap Reductn		0	0		0	0	0	0	0	0
Storage Cap Reductn		0	0		0	0	0	0	0	0
Reduced v/c Ratio		0.45	0.11		0.66	0.20	0.39	0.54	0.11	0.14

Intersection Summary

Cycle Length: 100
 Actuated Cycle Length: 100
 Offset: 65 (65%), Referenced to phase 2:EBTL and 6:WBTL, Start of Green
 Natural Cycle: 60
 Control Type: Actuated-Coordinated
 Maximum v/c Ratio: 0.77
 Intersection Signal Delay: 18.9
 Intersection Capacity Utilization 84.1%
 Analysis Period (min) 15

Intersection LOS: B
 ICU Level of Service E

Splits and Phases: 5: Oxford & Bayers

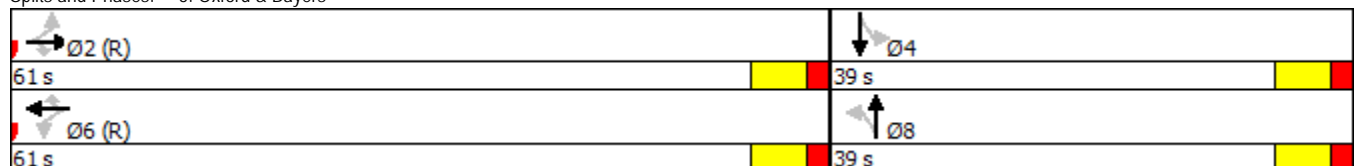

Halifax Transit Priority Corridors

6: Windsor & Bayers/Young

Lane Group	EBL	EBT	WBL	WBT	WBR	NBL	NBT	NBR	SBL	SBT
Lane Configurations										
Traffic Volume (vph)	90	410	140	420	150	120	455	140	60	190
Future Volume (vph)	90	410	140	420	150	120	455	140	60	190
Lane Group Flow (vph)	93	475	144	433	155	124	469	144	62	248
Turn Type	Perm	NA	pm+pt	NA	Perm	pm+pt	NA	Perm	Perm	NA
Protected Phases		2	1	6		3	8			4
Permitted Phases	2		6		6	8		8	4	
Detector Phase	2	2	1	6	6	3	8		4	4
Switch Phase										
Minimum Initial (s)	10.0	10.0	7.0	10.0	10.0	7.0	10.0	10.0	10.0	10.0
Minimum Split (s)	31.1	31.1	11.0	31.0	31.0	11.0	39.0	39.0	39.0	39.0
Total Split (s)	39.0	39.0	11.0	50.0	50.0	11.0	50.0	50.0	39.0	39.0
Total Split (%)	39.0%	39.0%	11.0%	50.0%	50.0%	11.0%	50.0%	50.0%	39.0%	39.0%
Yellow Time (s)	4.1	4.1	4.0	4.0	4.0	4.0	4.1	4.1	4.1	4.1
All-Red Time (s)	3.0	3.0	0.0	3.0	3.0	0.0	2.9	2.9	2.9	2.9
Lost Time Adjust (s)	0.0	0.0	0.0	0.0	0.0	0.0	0.0	0.0	0.0	0.0
Total Lost Time (s)	7.1	7.1	4.0	7.0	7.0	4.0	7.0	7.0	7.0	7.0
Lead/Lag	Lag	Lag	Lead			Lead			Lag	Lag
Lead-Lag Optimize?										
Recall Mode	C-Max	C-Max	None	C-Max	C-Max	None	Ped	Ped	Ped	Ped
Act Effect Green (s)	31.9	31.9	46.0	43.0	43.0	46.0	43.0	43.0	32.0	32.0
Actuated g/C Ratio	0.32	0.32	0.46	0.43	0.43	0.46	0.43	0.43	0.32	0.32
v/c Ratio	0.37	0.95	0.66	0.62	0.23	0.32	0.67	0.21	0.27	0.50
Control Delay	27.1	58.0	32.8	27.1	3.8	18.5	28.5	3.9	29.2	30.2
Queue Delay	0.0	0.0	0.0	0.0	0.0	0.0	0.0	0.0	0.0	0.0
Total Delay	27.1	58.0	32.8	27.1	3.8	18.5	28.5	3.9	29.2	30.2
LOS	C	E	C	C	A	B	C	A	C	C
Approach Delay		52.9		23.3			22.0			30.0
Approach LOS		D		C			C			C
Queue Length 50th (m)	9.5	90.3	16.2	63.7	0.0	13.7	70.8	0.0	8.9	36.4
Queue Length 95th (m)	20.5	#145.6	#32.3	95.8	11.0	24.9	106.0	10.6	20.0	59.9
Internal Link Dist (m)		309.1		142.1			493.5			927.7
Turn Bay Length (m)	50.0		40.0		80.0	90.0		50.0	40.0	
Base Capacity (vph)	253	501	219	694	679	386	704	672	232	494
Starvation Cap Reductn	0	0	0	0	0	0	0	0	0	0
Spillback Cap Reductn	0	0	0	0	0	0	0	0	0	0
Storage Cap Reductn	0	0	0	0	0	0	0	0	0	0
Reduced v/c Ratio	0.37	0.95	0.66	0.62	0.23	0.32	0.67	0.21	0.27	0.50

Intersection Summary

Cycle Length: 100
 Actuated Cycle Length: 100
 Offset: 77 (77%), Referenced to phase 2:EBTL and 6:WBTL, Start of Green
 Natural Cycle: 95
 Control Type: Actuated-Coordinated
 Maximum v/c Ratio: 0.95
 Intersection Signal Delay: 30.9
 Intersection Capacity Utilization 92.3%
 Analysis Period (min) 15
 # 95th percentile volume exceeds capacity, queue may be longer.
 Queue shown is maximum after two cycles.

Intersection LOS: C
 ICU Level of Service F

Splits and Phases: 6: Windsor & Bayers/Young

11 s	39 s	11 s	39 s
50 s		50 s	

Macdonald Bridge Ramp Modifications Final Report



181063.00 • Final Report • October 2018

Prepared for:

HALIFAX

Prepared by:



CBCL LIMITED

Consulting Engineers

Final Report - Revised	M. MacDonald	Oct. 24, 2018	E. Nicolescu
Final Report	M. MacDonald	Oct. 10, 2018	E. Nicolescu
Draft Report	M. MacDonald	Sept 10, 2018	E. Nicolescu
<i>Issue or Revision</i>	<i>Reviewed By:</i>	<i>Date</i>	<i>Issued By:</i>
 <p>CBCL LIMITED Consulting Engineers</p>		<p>This document was prepared for the party indicated herein. The material and information in the document reflects CBCL Limited's opinion and best judgment based on the information available at the time of preparation. Any use of this document or reliance on its content by third parties is the responsibility of the third party. CBCL Limited accepts no responsibility for any damages suffered as a result of third party use of this document.</p>	



CBCL LIMITED

Consulting Engineers

October 24, 2018

Tanya Davis, P.Eng., PTOE
Strategic Transportation Planning Program Manager
Halifax Regional Municipality
PO Box 1749
Halifax, NS B3J 3A5
davist@halifax.ca

1489 Hollis Street
PO Box 606
Halifax, Nova Scotia
Canada B3J 2R7

Telephone: 902 421 7241
Fax: 902 423 3938
E-mail: info@cbcl.ca
www.cbcl.ca

**Solving
today's
problems
with
tomorrow
in mind**

Dear Ms. Davis:

RE: Macdonald Bridge Ramp Modifications

We are pleased to provide you with the revised final report for the Macdonald Bridge Ramp Modifications assignment, which supersedes the report dated October 10, 2018.

It includes construction cost estimates and sketches for each modification option, addresses the draft report comments received from HRM. We trust that this report meets your needs at this time in the ongoing effort to improve public transit service and reliability within HRM.

Please do not hesitate to contact us if you have any questions or require more information.

Yours truly,

CBCL Limited

Original Signed

Original Signed

MacDonald, P.Eng.
Senior Transportation Engineer
Direct: 902 892 0303
E-Mail: markmacd@cbcl.ca

Mark
Emanuel Nicolescu, RPP, MCIP
Transportation Planner
Direct: 902-421-7241
E-Mail: enicolescu@cbcl.ca

Cc: Harrison McGrath, P.Eng, HRM

Project No: 181063.00



Contents

CHAPTER 1	Introduction	3
1.1	Project Background.....	3
1.2	Project Understanding.....	4
1.2.1	Vehicle Swept-Path Analysis.....	4
1.2.2	Field Test.....	4
1.3	Project Scope	5
1.4	Data Collection.....	5
CHAPTER 2	Geometric Review.....	9
2.1	Vehicle Swept-Path Analysis.....	9
CHAPTER 3	Field Test	13
CHAPTER 4	Operational Review	16
4.1	Introduction	16
4.2	Average Volumes	17
4.3	95 th Percentile Volumes.....	18
CHAPTER 5	Potential Solutions.....	20
5.1	Option 1 – Outside Lane Bus-Only.....	20
5.2	Option 2 – Outside Lane Widening.....	22
5.3	Option 3 – Add Outside Lane	23
5.4	Option 4 – Add Inside Lane.....	24
CHAPTER 6	Options Evaluation.....	25
6.1	Evaluation Criteria	25
6.2	Bus turning ability.....	25
6.3	Impacts on Pedestrian Circulation.....	26
6.4	General vehicular traffic impacts.....	27
6.5	Bridge impacts	28
6.6	Constructability.....	28
6.7	Cost estimates.....	33
CHAPTER 7	Conclusion	35
7.1	Recommendation.....	35

Appendices

- A HRM - Bus Vehicle Swept-Path AutoTurn Analysis
- B HRM - North St. / Barrington St. Ramp Count Aug30-18
- C Potential Solutions
- D Vehicle Swept-Path Analysis
- E Option Constructability
- F Opinion of Probable Construction Costs

CHAPTER 1 INTRODUCTION

1.1 Project Background

The Macdonald Bridge, connecting Halifax and Dartmouth, was built in 1955. Significant retrofit in 1998 replaced and widened the bridge deck, and added a reversible centre lane as well as pedestrian and cyclist corridors. The approaches to the bridge were also redesigned to the current configuration. The bridge is restricted to vehicles less than 3,200kg so it primarily serves passenger vehicle and light truck traffic; heavy trucks must use the MacKay Bridge. Several Halifax Transit bus routes also use the bridge, but because the 1998 retrofit design did not allow for buses, they are not currently able to manoeuvre the right turn from the Barrington Street ramp into the right lane on the bridge without encroaching into the centre lane. Halifax Transit would like to re-route some Dartmouth-bound buses from Gottingen Street to Barrington Street which would entail using the ramp to access the Macdonald Bridge. CBCL was contracted to investigate this geometric constraint and provide possible solutions and recommendations to address the current bus service limitation.

The study area for this exercise is bounded by Gottingen Street and Barrington Street, focusing on the Halifax end of the Macdonald Bridge; the eastbound approach of North Street and the Barrington Street northbound on-ramp in particular (see Figure 1).

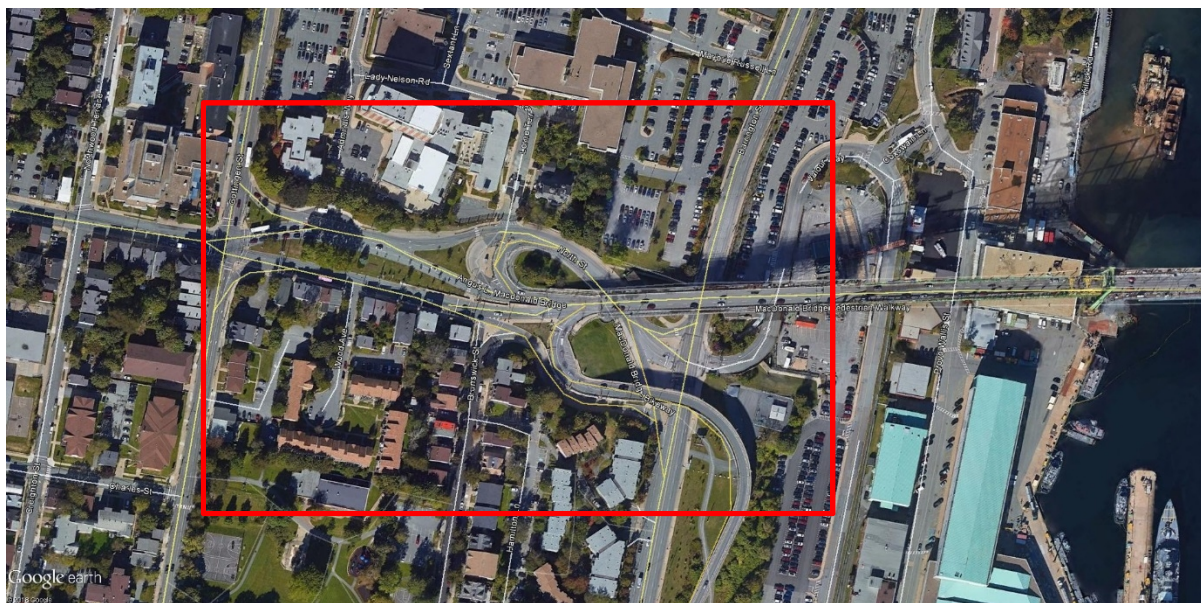

Figure 1 Study Area

The bridge's centre reversible lane carries Halifax-bound traffic between midnight and noon, and Dartmouth-bound traffic from noon to midnight each day. Access to the bridge on the Halifax end is possible from either North Street or a ramp from northbound Barrington Street. These two-lane approaches are controlled by a traffic signal, as well as gates that block access to the centre lane during the midnight-to-noon period.

1.2 Project Understanding

No transit routes currently use the Barrington Street ramp because the geometry does not allow Halifax Transit buses (both standard and articulated) to safely navigate the right turn into the right lane on the bridge without encroaching into the centre lane. In the morning, this manoeuvre would interfere with oncoming Halifax-bound traffic in the centre lane, and in the afternoon it could result in a bus side-swiping a Dartmouth-bound vehicle turning into the centre bridge lane from the left ramp lane.

From discussion with HRM staff, it is understood that during the weekday PM peak hour, close to 70 buses are routed across the Macdonald Bridge via Gottingen Street north and south. With Halifax Transit's ongoing service expansion and route changes, it is anticipated that this number could increase to 90 buses per peak hour. Several routes could be considered for rerouting to Barrington Street and the Barrington Street bridge ramp, should the execution of the right turn movement on to the bridge be shown to be possible and safe.

Halifax Transit carried out a preliminary review to identify the challenges and safety concerns for buses making the right turn from the ramp. This included both a geometric vehicle swept-path analysis and a field test in October 2017, while Halifax Harbour Bridges (HHB) closed the bridge to traffic.

1.2.1 Vehicle Swept-Path Analysis

Vehicle swept path analysis undertaken by HRM using AutoTurn software suggests that both standard (40 foot) and articulated (60 foot) buses would very narrowly encroach into the centre lane; these analyses are included in Appendix A.

1.2.2 Field Test

As noted above, an October 2017 field test investigated initiating bus turns from the Barrington Street on-ramp into the right lane on the bridge using the following four manoeuvres: 1) from the right lane, 2) straddling the lane separation, 3) from the left lane, and 4) from the right lane, using a "button-hook" manoeuvre turning to the left before swerving back right. Figure 2 was created by HRM to illustrate the four intended movements.

Each manoeuvre was executed only once, using four standard 40 foot buses. Unfortunately, the third bus, which was turning from the ramp's left lane, executed the turn movement incorrectly, and entered the bridge's centre lane instead of the curb lane. The other three manoeuvres were done correctly and all three narrowly crossed the centre lane markings on the bridge, confirming the

findings of the AutoTurn analysis. Without lane markings through the intersection, it was difficult to assess the extent of the encroachment until the buses reached the lane lines on the bridge.



Figure 2 October 2017 Field Test

1.3 Project Scope

To investigate any potential changes that could be made to improve the current situation and allow all Halifax Transit buses to make this right turn safely and without hindering other traffic movements, we undertook the following tasks:

1. Review the current geometry of the intersection between the bridge approach and the ramp;
2. Review existing morning and afternoon traffic operations; and
3. Identify potential changes that could be made to allow Halifax Transit buses to safely turn right from the Barrington Street ramp on to the Macdonald Bridge.

We have investigated each option and provide a thorough review of the implications with regards to interaction with the bridge structure, and to impacts on traffic operations and circulation.

1.4 Data Collection

Key project personnel visited the site on August 2nd, 2018, to gain a deeper appreciation and understanding of the existing infrastructure and geometric constraints, and the concerns with buses making a right turn from the Barrington Street ramp.

AutoCAD drawings of the bridge approach and ramp geometry were provided by HHB. Drawings cover the original reconstruction of the bridge approaches in 1998.

Halifax Regional Municipality provided a subset of the downtown Halifax Synchro model, with counts dating from 2011 and 2014. An updated count of the North Street / Barrington Street on-ramp intersection was also undertaken on August 30th, 2018 (count data is provided in Appendix A). Peak hour vehicular volumes, balanced to the August 30th counts are, illustrated in Figure 3 and Figure 4 for the weekday AM and PM peak hours, respectively. The AM peak hour was found to occur from 7:30 to 8:30, while the PM peak hour occurred between 15:30 and 16:30.

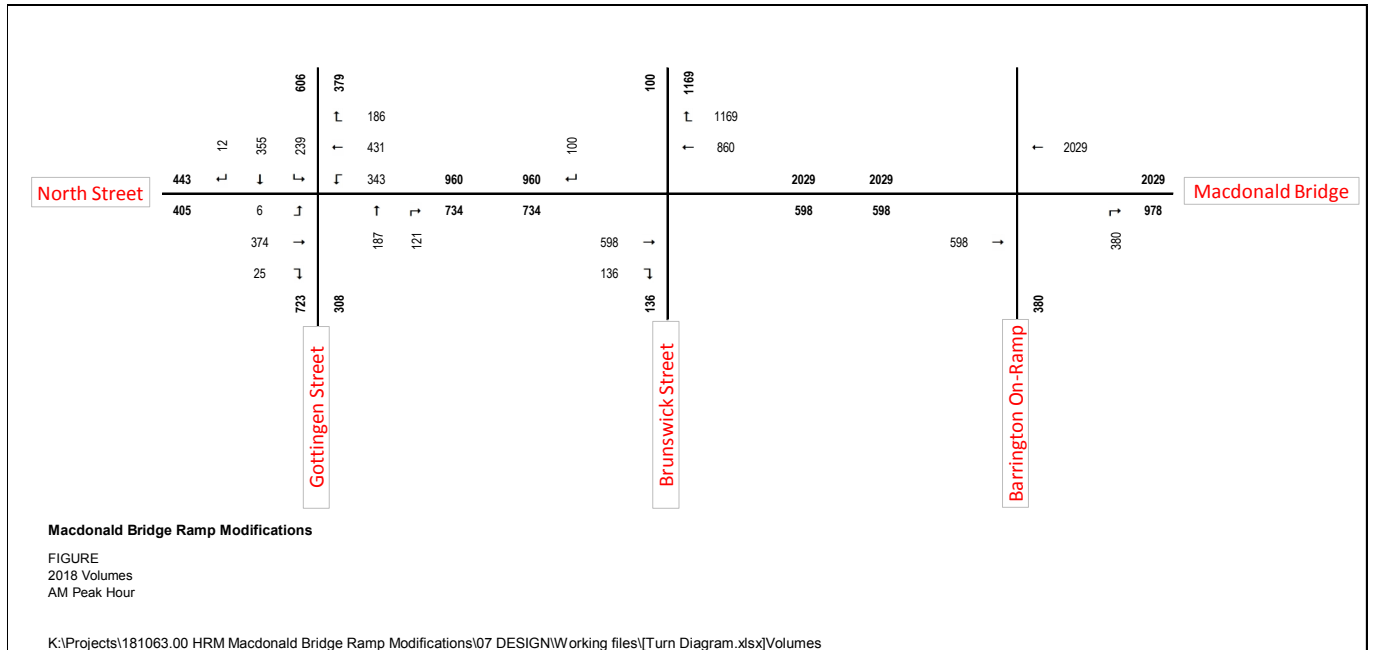

Figure 3 Existing AM Peak Hour Vehicular Volumes

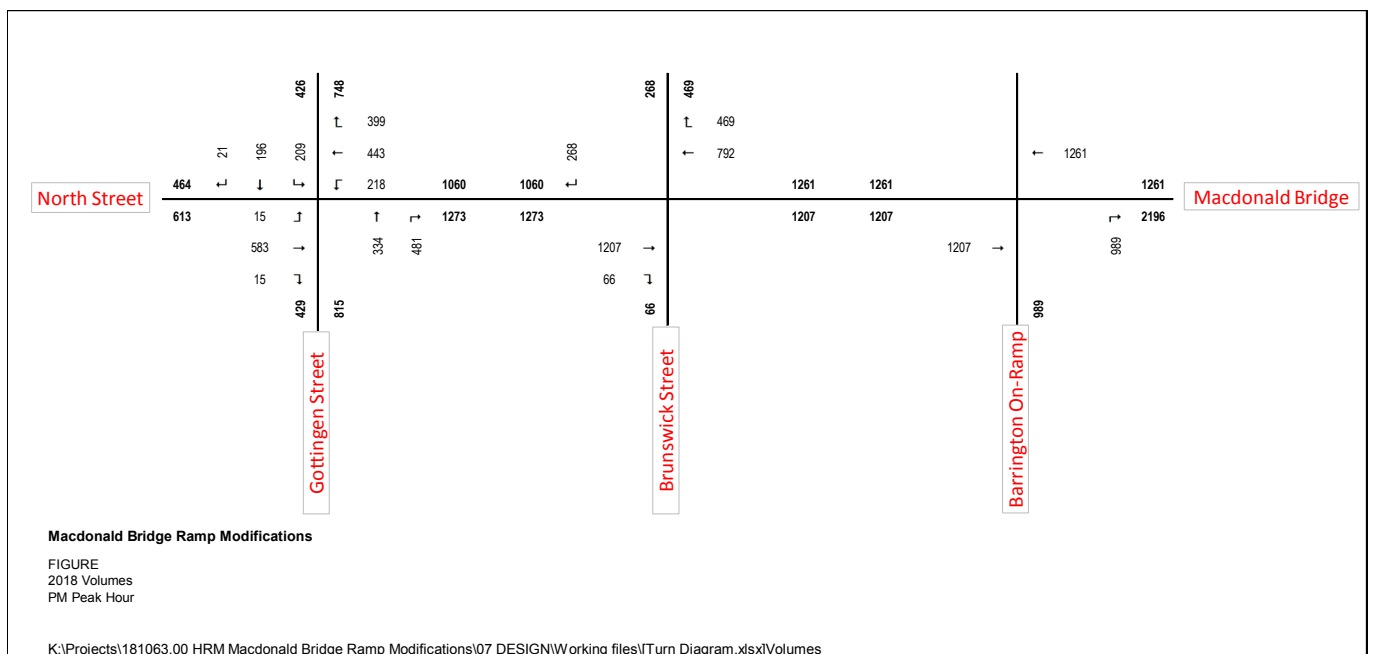

Figure 4 Existing PM Peak Hour Vehicular Volumes

Overall we note that the Barrington Street on-ramp carries close to 400 vehicles turning on to the Macdonald Bridge during the morning peak hour, and close to 1,000 vehicles during the afternoon peak hour. Volumes on the bridge exhibit clear directionality, with peak Halifax-bound morning flows changing direction to Dartmouth-bound in the afternoon. Total two-way PM volumes are slightly higher than AM volumes.

Data from the Thursday August 30th, 2018 count was reviewed against historical trends. HHB provided monthly bridge crossing vehicular volumes for the period 1996-2017. Review of the data revealed generally stable travel patterns over the period, with the exception of very notable reductions in vehicular bridge crossings in 1998 and 2016, corresponding with significant bridge reconstructions (see Figure 5). The effect of the construction is visible in the gap between the yearly average monthly vehicular volumes and the 95th percentile levels. Converted to annual average daily traffic volumes (AADT), this represents a gap of over 6,000 vehicles a day.

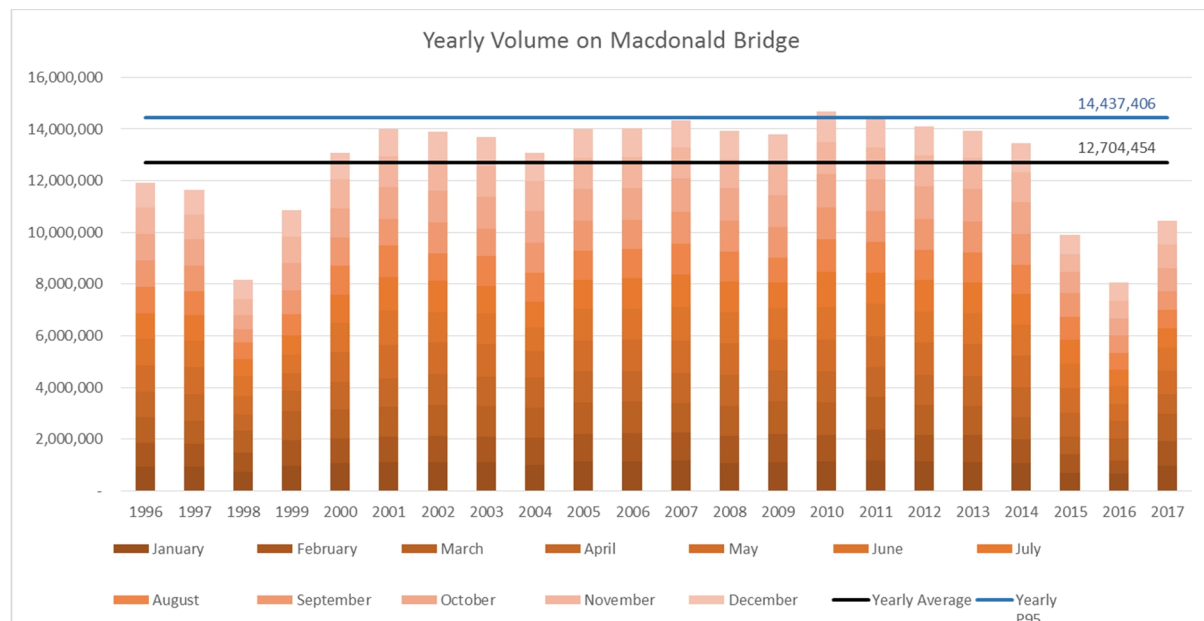

Figure 5 Yearly Vehicular Bridge Crossings, by Month

A peak hour day count was also provided for the date of April 25th, 2014 which experienced the highest daily volume for the 1996-2017 period. Comparing with the 2018 count revealed that the latest count is approximately 14% lower than the 2014 count during the weekday AM peak hour, and 8% lower during the weekday PM peak hour.

To further compare the 2018 count to the historical trend, the current peak hour volumes were factored to a full day, using the peak-hour/average day relationship of the April, 2014 count data. Based on this assumption that the latest count would exhibit the same peak-hour/day relationship as in 2014, we found that the present count is comparable to the average daily volume, but significantly lower than the 95th percentile daily volume (see Table 1). The AM peak hour volume

would appear to be approximately 19% lower than the 95th percentile volume, while the PM peak hour is 13% lower.

Table 1 Historical Count Data Review

		Morning 8-9am		Afternoon 4-5pm	
To Halifax	2014	2,192		1,427	
	2018	1,846		1,301	
	Δ	-346	-16%	-126	-9%
To Dartmouth	2014	1,163		2,212	
	2018	1,033		2,052	
	Δ	-130	-11%	-160	-7%
Facility Total	2014	3,355		3,639	
	2018	2,879		3,353	
	Δ	-476	-14%	-286	-8%
Daily Volume*	2018	33,294		35,750	
	Apr-14	38,799		38,799	
	Δ	(5,505)	-14%	(3,049)	-8%
	1996-2017 Daily Average	34,788		34,788	
	Δ	(1,494)	-4%	962	3%
	1996-2017 Daily 95th Percentile	40,883		40,883	
Δ	(7,588)	-19%	(5,133)	-13%	

$$*L = \frac{V_{L} - V_{A}}{V_{A}} \times 100$$

CHAPTER 2 GEOMETRIC REVIEW

2.1 Vehicle Swept-Path Analysis

Using the site drawings provided by HHB, we carried out a review of the existing roadway geometry as it relates to the bus right-turn movement. The Autodesk Vehicle Tracking software provides an analysis of a moving vehicle's swept-path through a broad range of manoeuvres. Vehicle models were customized to reproduce the physical parameters, steering and handling characteristics of Halifax Transit's 40 foot standard buses and 60 foot articulated buses, using vehicle specifications and dimensions supplied by them. A large van (Mercedes Sprinter Panel Van) was also used to represent the largest vehicle permitted within the weight restriction. The Vehicle Tracking analysis included a 0.5m clearance buffer to the precise vehicle body and swept-path calculations, helping account for variability between different drivers, and providing some measure of a consistent vehicle envelope.

By reproducing a series of right-turn movements, this analysis allowed us to visualize the spatial envelope needed for the complete movement to be made with both bus types, and to identify any areas where the envelope encroaches into the centre lane or beyond the curb line. The movements evaluated by HRM using AutoTurn were reproduced, and are illustrated in Figure 6 to Figure 9. Detailed plans are included in Appendix D. The analysis evaluated turns from both inside and outside lanes, even though buses cannot presently turn from the outside lane, as current operations would direct them into the centre bridge lane, and requiring them to merge back into the right bridge lane, an unsafe manoeuvre for buses due to limited visibility on the right side and heightened possibility of conflict with vehicles on the right. Current traffic signal timing plans also preclude buses from turning from the left ramp lane into the right bridge lane due to conflicting movements with inside ramp lane.

The vehicle swept-path analysis indicates that, to safely execute the right-turn from the inside lane, into the right bridge lane both the 40 foot standard and 60 foot would have to cross the lane separation at the on-ramp stop bar and encroach into the left lane (see Figure 6 and Figure 7). Turns from the outside lane, however, were found to be more consistently feasible for both the 40 foot standard and the 60 foot articulated buses, with more clearance and less likelihood of encroachment into adjacent lanes (see Figure 8 and Figure 9). The analysis was also conducted using

the large van turning concurrently from the left lane into the centre lane, to simulate the bridge's operation during the PM period.

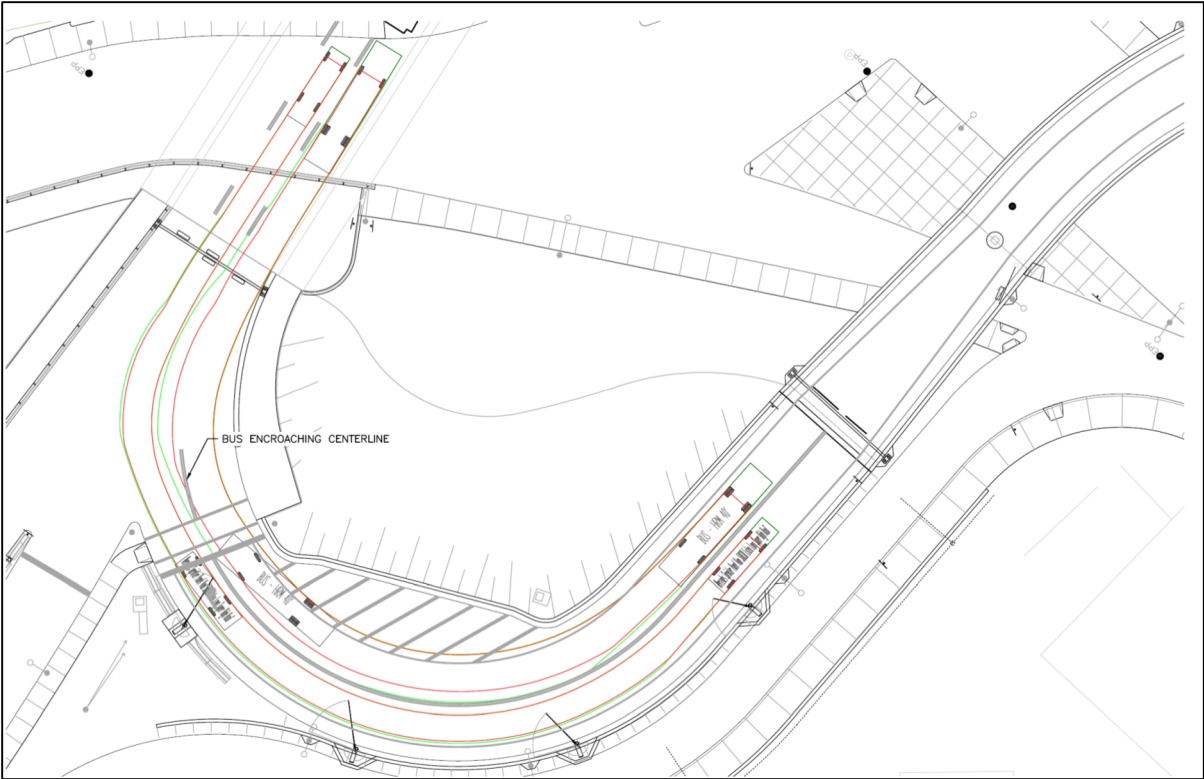

Figure 6 Standard 40 foot Bus Turning from Inside Lane, in Parallel with Large Van Turning from Outside Lane

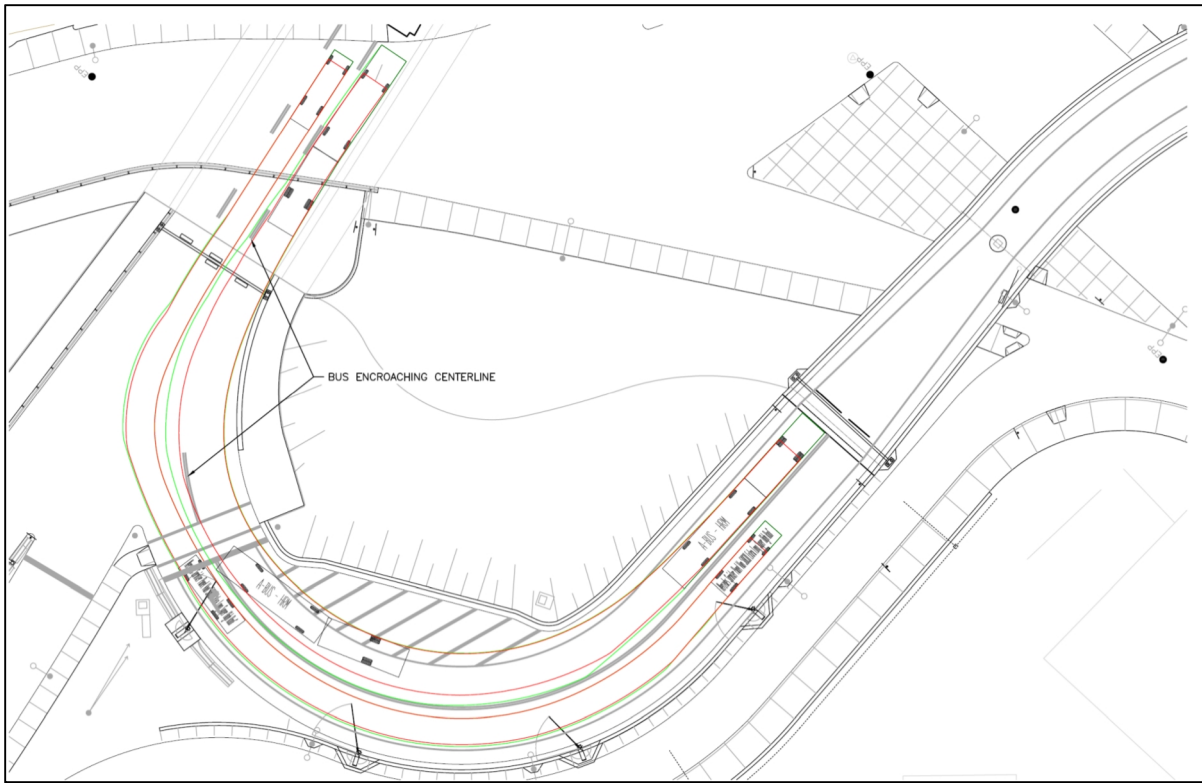

Figure 7 Articulated 60 foot Bus Turning from Inside Lane, in Parallel with Large Van Turning from Outside Lane

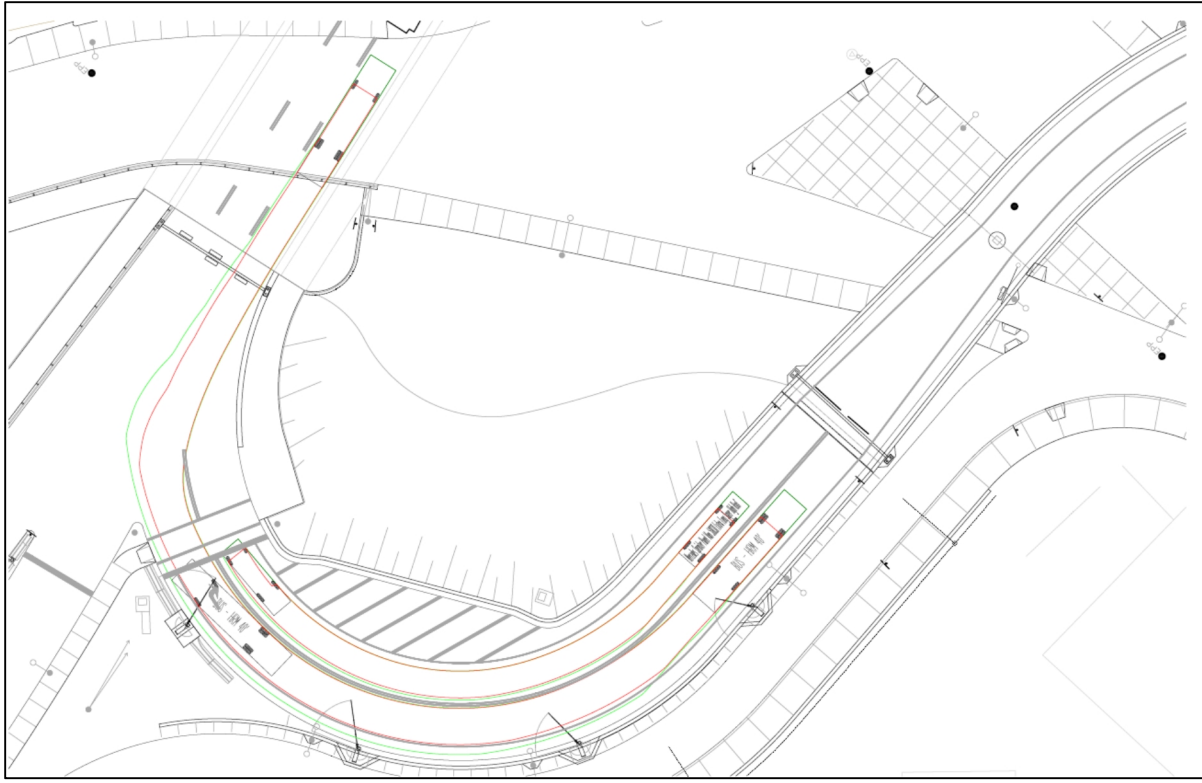

Figure 8 Standard 40 foot Bus Turning from Outside Lane, in Parallel with Large Van Turning from Inside Lane

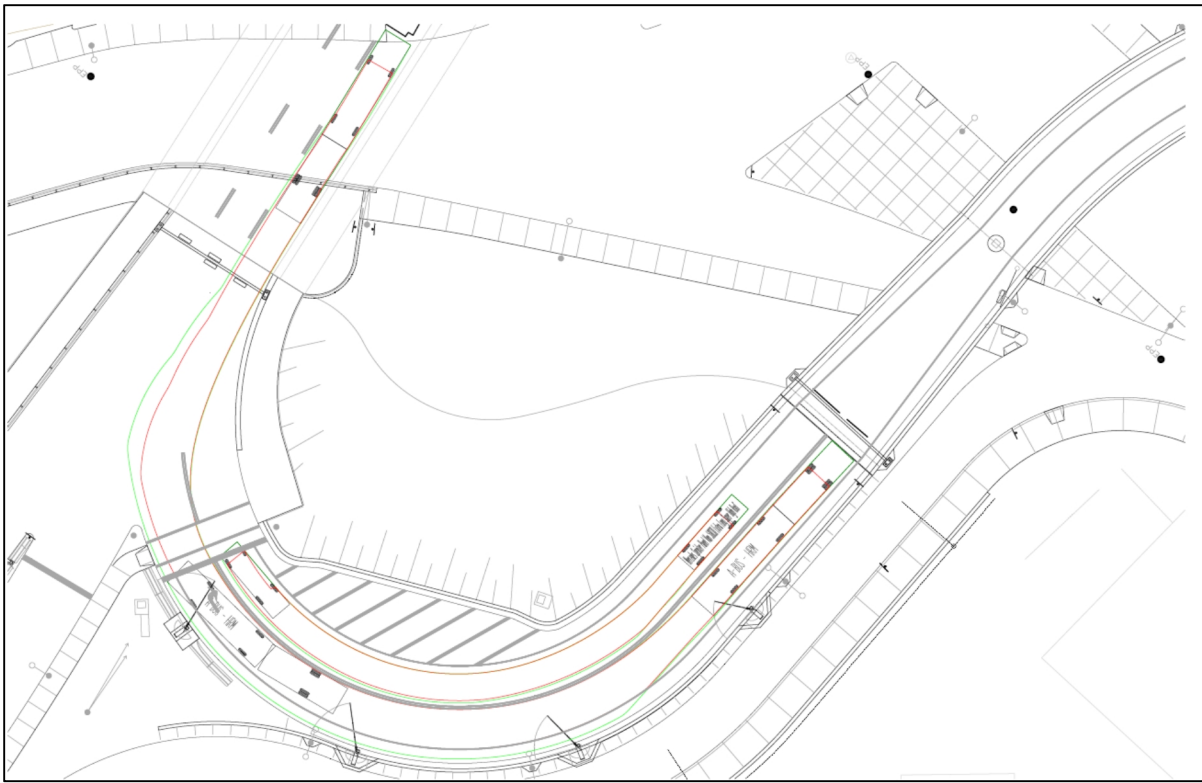

Figure 9 Articulated 60 foot Bus Turning from Outside Lane, in Parallel with Large Van Turning from Inside Lane

CHAPTER 3 FIELD TEST

To confirm the validity of the vehicle swept-path analysis, a more in-depth field test was conducted on Saturday, September 22nd, 2018, from 7:30 a.m. to 9:30 a.m. Using two (2) 40 foot buses and one (1) articulated 60 foot bus, the field test evaluated turning from the right ramp lane to the right bridge lane (see Figure 10) and turning from the left ramp lane to the right bridge lane (see Figure 11). While the latter movement is not feasible under current signal operation, it was nonetheless tested to understand buses' physical turning ability. Each bus executed a full manoeuvre from each lane, for a total of six (6) trials.

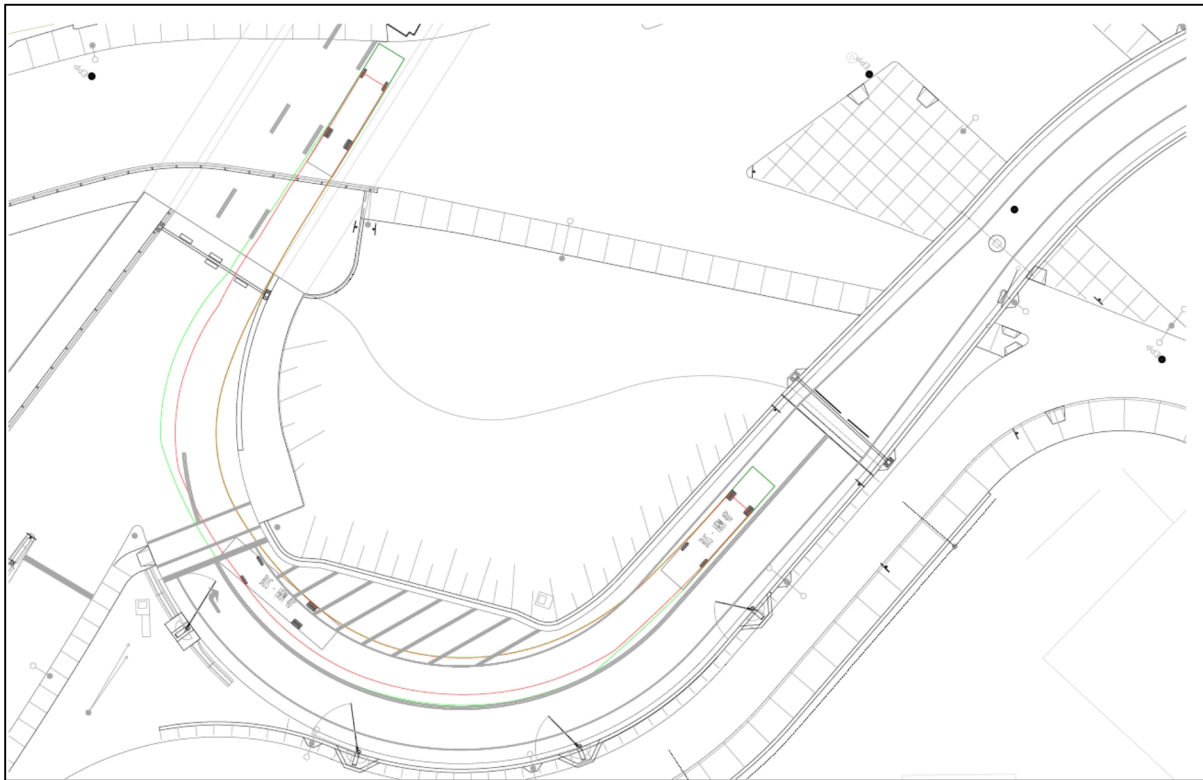

Figure 10 Turning from Inside Lane

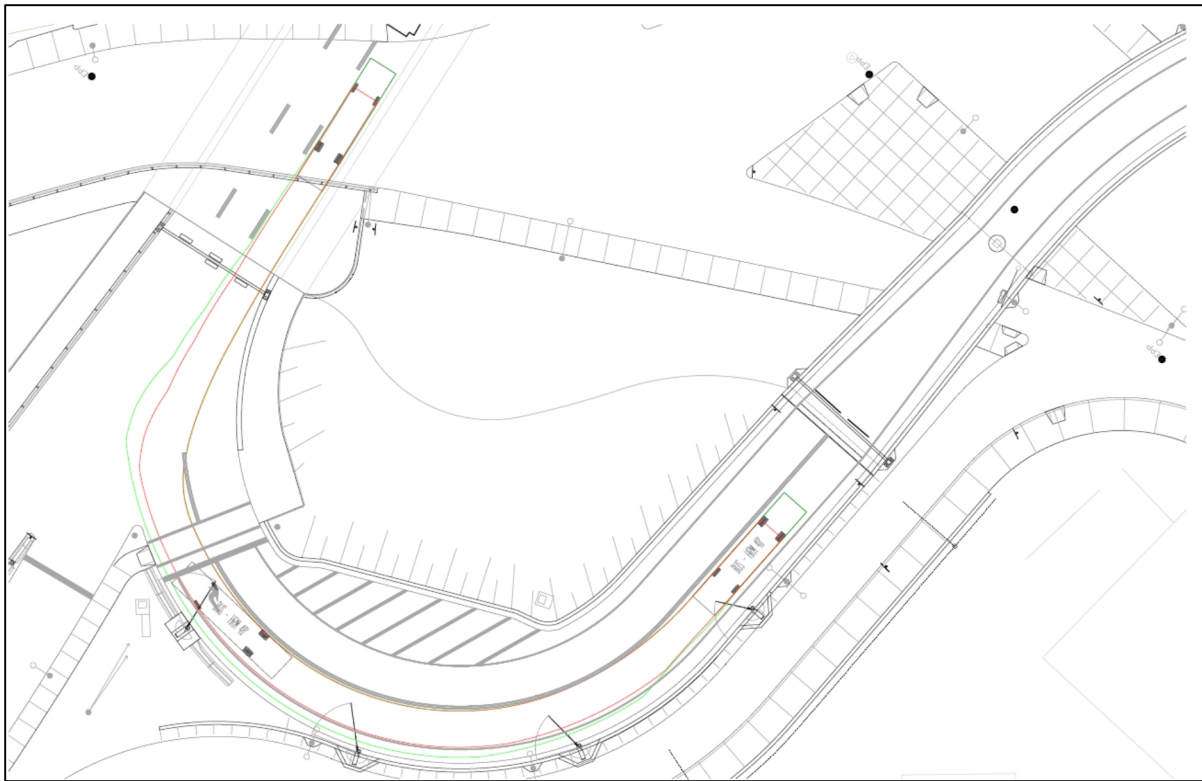

Figure 11 Turning from Outside Lane

The field test demonstrated that, in order to execute the right turn from the inside lane, a standard 40 foot bus had to encroach into the left lane at the on-ramp stop bar. The articulated 60 foot bus, could not execute the turn from the inside lane without significantly encroaching into the centre bridge lane. It was found that the overhead gantry pole located at the south-west corner of the bridge structure impeded the passage of the bus, forcing it to adopt a wider turn and encroach upon the centre bridge lane.

Both standard 40 foot and articulated 60 foot buses were found to be able to turn into the bridge right lane from the on-ramp outside lane, with a comfortable clearance and without encroaching onto adjacent lanes.

One additional manoeuvre was tested, whereby the right lane turn was re-oriented westwards to provide additional clearance for buses. This configuration was simulated using traffic cone placement, and is illustrated in Figure 12. It was found that both bus types are able to negotiate the right turn manoeuvre within the additional space.

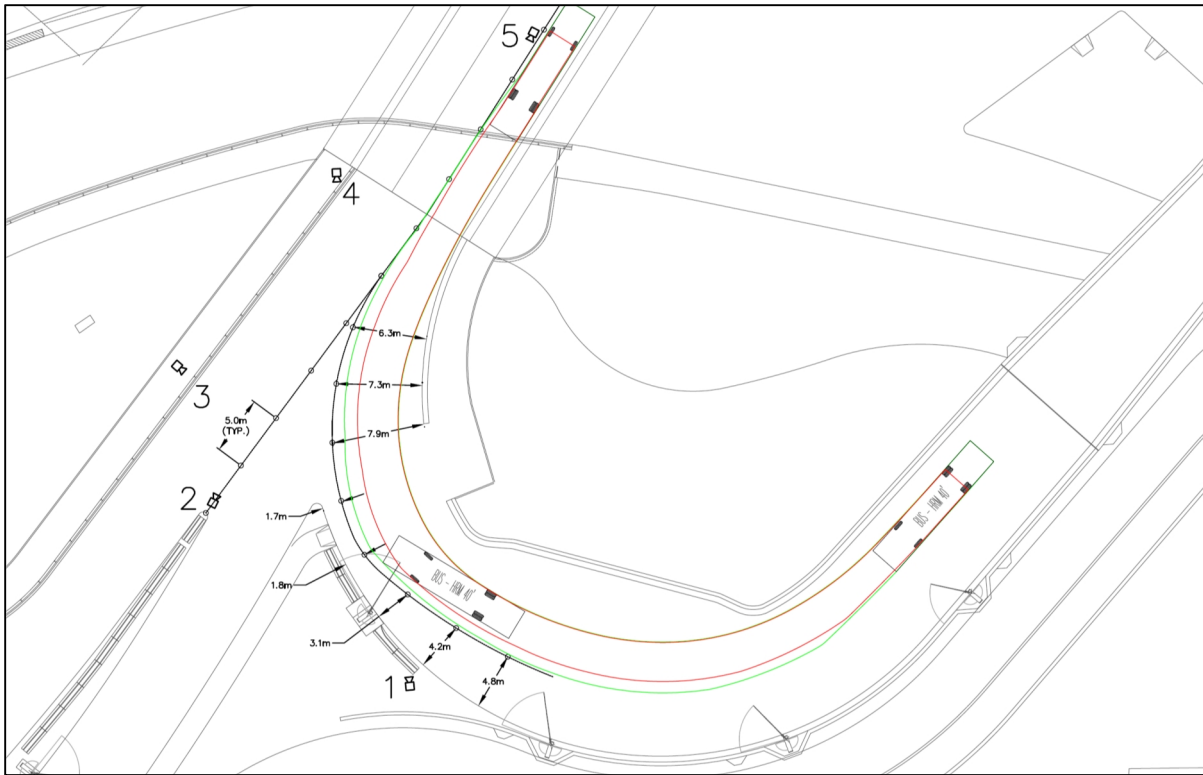

Figure 12 Turning from Modified Inside Lane



Figure 13 Successful Turning Movement of Articulated 60 foot bus into the Bridge Right Lane, Using the Modified Inside Lane

CHAPTER 4 OPERATIONAL REVIEW

4.1 Introduction

Using current signal timing information and peak hour morning and afternoon traffic volume data, CBCL utilized Synchro software and the downtown Halifax Synchro model to analyse existing traffic operations for ramp traffic approaching the Macdonald Bridge. The Synchro model, which uses the capacity analysis methodology of the Highway Capacity Manual 2000, was updated with the 2018 vehicle volumes, reviewed and field calibrated, with modifications made as necessary so that it closely represents operations during the morning and afternoon peak periods. Specifically, it was observed that the lane utilization on the Halifax approach to the bridge is unbalanced. In the afternoon, 57% of Dartmouth-bound vehicles used the right lane, in anticipation of turning right on to Wyse Road in Dartmouth. The lane utilization factor in Synchro was therefore modified accordingly for both peak hours.

During multiple site visits by HRM and CBCL staff, it was observed that, during the PM peak period, queues routinely spill back along Barrington Street beyond the northbound on-ramp, as well as on North Street eastbound. In discussion with HRM staff and through review of video footage from a number of locations along Barrington Street and along North Street, it is apparent that queueing may extend on Barrington Street as far south as Cornwallis Street, and on North Street as far west as Robie Street. Such conditions could not be entirely replicated in the downtown Halifax Synchro model, as the model was calibrated for the Barrington northbound on-ramp and North Street intersection only, and as Synchro evaluates each intersection in isolation. At this intersection, the model tends to overestimate capacity, with resulting underestimated queue lengths. The observed real-life conditions could be more correctly approximated in the model by either increasing the vehicular demand, or by reducing the saturated flow rates for queueing movements. For the purposes of the current analysis, Synchro's Central Business District (CBD) area type parameter was used; this adjusts the saturated flow rate to correspond to what might be observed in a typical CBD, or at intersections exhibiting factors such as tight turning radii, narrow rights of way, high pedestrian volumes, or significant curb-side activity. The study area does exhibit very tight turning radii on the on-ramp approach to the bridge, and the crash barriers and lane gates tend to narrow the perception of the ROW considerably. The model thus calibrated does achieve more realistic results. We note that the review of the model's SimTraffic simulation module does reveal the production of more significant queues during the PM peak hour.

Two evaluation scenarios were devised, to account for the August 30th, 2018 count being relatively low, when compared to historical counts. The 2018 vehicular volumes were first assessed as is, considering that they reflect very closely the historical average. However, since the historical average is skewed by the two construction periods in 1998 and 2016, the 95th percentile volumes was taken as more representative of typical saturated conditions. Operations were subsequently also evaluated with 2018 vehicular volumes factored to the 95th percentile level or the period 1996-2017, to assess the situation under saturated conditions.

4.2 Average Volumes

Under average conditions, Halifax approach to the Macdonald Bridge is observed to operate with very good levels of service (LOS) during the weekday AM peak hour, with residual capacity and short delays (see Table 2). The Barrington Street northbound on-ramp experiences very short queues of approximately 17m (3 vehicles) on average and up to an occasional 45m (6 or 7 vehicles), which clear the intersection within one signal cycle.

During the weekday PM peak hour, the intersection is observed to operate very close to, or at theoretical capacity on both the eastbound North Street and northbound on-ramp approaches. North Street may experience the accumulation of 119m (16 vehicles) on average, extending to 156m or more when the movement approaches capacity. While the signal coordination on North Street allows the queues to clear within approximately 21 seconds, the queue does spill back to the Gottingen intersection, where this delay induces additional delay on the eastbound flow and compounds additional delay experienced there. The spillback effect tends to aggravate further west, with the result of combined queue felt as far west as Robie Street. The Barrington on-ramp, however, experiences delays exceeding one 90-second signal cycle, resulting in the formation of long queues. Since the northbound volume exceeds the movement's theoretical capacity, the actual queue length may extend beyond the 84m-150m queues calculated by Synchro. Review of SimTraffic simulation suggests queues would routinely extend to Barrington Street. Review of camera footage and discussion with HRM staff confirms that these queues do extend through the intersection of Barrington Street with Cornwallis Street, even blocking northbound flows during green phases.

Table 2 Intersection Capacity Analysis - Average Volumes

Intersection	Lane / Movement	AM Peak Hour					PM Peak Hour				
		Average Q (m)	95th % Q ¹ (m)	V/C Ratio ²	Average Delay ³ (s)	LOS ⁴	Average Q (m)	95th % Q ¹ (m)	V/C Ratio ²	Average Delay ³ (s)	LOS ⁴
North Street & Barrington Street Northbound On-Ramp	EB Thru	10.4	13.5	0.73	10.4	B	118.6	#155.7	0.98	21.4	C
	NB Right	16.8	45.2	0.54	28.3	C	~83.8	#150.1	1.14	99.3	F
	Overall			0.85	9.4	A			1.10	44.2	D

Notes:

Analysis by CBCL Limited using Synchro 9.0

1. 95% Queue - 95th percentile queue [highlighted if >100m or if available storage is exceeded]
 2. V/C Ratio - Volume-to-Capacity ratio [highlighted if >0.90]
 3. Average Delay - average total delay per vehicle [highlighted for LOS E or F]
 4. LOS - Level of Service [highlighted for LOS E or F]
- ~. With V/C >= 1.0, the average queue is theoretically infinite
 #. With V/C >= 1.0, the 95th percentile queue is theoretically infinite

4.3 95th Percentile Volumes

Under the factored 95th percentile traffic conditions, the Synchro analysis demonstrates that the operation of the Macdonald Bridge intersection would deteriorate considerably (see Table 3). During the AM peak hour, delays would increase significantly on the Barrington on-ramp approach, rising from 28 seconds to close to 48 seconds. While average queues would only extend to an average of 6 vehicles, the occasional queue may double to 13 vehicles. 95th percentile queues are calculated to exceed the movement capacity, and could therefore extend beyond what is calculated by Synchro.

During the PM peak hour, 95th percentile volume factoring would severely aggravate the capacity constraints evaluated with average volumes. Both the North Street Dartmouth-bound approach and the Barrington on-ramp approach would experience delays of 1 to 3 minutes, respectively, with significant queueing as a result. These results are consistent with site observations, which indicate persistent queueing on these approaches extending well beyond the immediate study area.

Table 3 Intersection Capacity Analysis - 95th Percentile Volumes

Intersection	Lane / Movement	AM Peak Hour					PM Peak Hour				
		Average Q (m)	95th % Q ¹ (m)	V/C Ratio ²	Average Delay ³ (s)	LOS ⁴	Average Q (m)	95th % Q ¹ (m)	V/C Ratio ²	Average Delay ³ (s)	LOS ⁴
North Street & Barrington Street Northbound On-Ramp	EB Thru	12.8	#172.3	0.89	16.9	B	~171.9	#188.1	1.12	67.1	E
	NB Right	43.1	#95.2	0.87	47.5	D	~141.8	#186.0	1.32	175.7	F
	Overall			1.04	22.4	C			1.27	98.1	F

Notes:

Analysis by CBCL Limited using Synchro 9.0

1. 95% Queue - 95th percentile queue [highlighted if >100m or if available storage is exceeded]
 2. V/C Ratio - Volume-to-Capacity ratio [highlighted if >0.90]
 3. Average Delay - average total delay per vehicle [highlighted for LOS E or F]
 4. LOS - Level of Service [highlighted for LOS E or F]
- ~. With V/C >= 1.0, the average queue is theoretically infinite
 #. With V/C >= 1.0, the 95th percentile queue is theoretically infinite

CHAPTER 5 POTENTIAL SOLUTIONS

To minimize disruption to the bridge approach and to exhaust all options, we first investigated operational changes to the approaches on to the Macdonald Bridge, followed by geometric changes. Initial discussion was undertaken with HRM staff concerning the opportunity to use smaller bus models or specialized buses with rear axle steering, which would permit tighter turning radii and allow right-turns from the right lane. Considering current and planned bus fleet procurement, however, such options are unavailable at this time. Such new vehicle types would have a negative impact on operational efficiency as they may not be efficiently used on other lines in the system. This category of changes was therefore not carried forward to analysis.

All proposed options are illustrated in detail in Appendix C. We note that extending lane markings in the Halifax-bound direction across the intersection would provide additional guidance to bus drivers and Halifax-bound vehicles of their permissible right-of-way. The current lack of such markings makes it difficult for approaching buses to accurately gauge their position with regards to Halifax-bound centre lane.

5.1 Option 1 – Outside Lane Bus-Only

During the weekday AM peak hour, when the bridge centre lane is open for Halifax-bound traffic, the Barrington Street on-ramp may operate with one lane for general traffic. With insertion of a leading transit phase in the signal cycle, Halifax Transit vehicles may use the left lane as a queue bypass lane. Upon detection at the approach to the intersection, buses would call the bus phase between the Dartmouth-bound green phase and the general ramp traffic green phase at the start of the following cycle. It is understood that, while current actuation is achieved through ground-based induction loops, other detection methods could be installed in the future. The Halifax-westbound phase would remain in green phase throughout the cycle. The lane barriers currently restricting vehicular access into the left lane would be removed, with access controlled via the overhead gantry variable signage located at the top of the ramp, before the approach opens up on two lanes (see Figure 14).

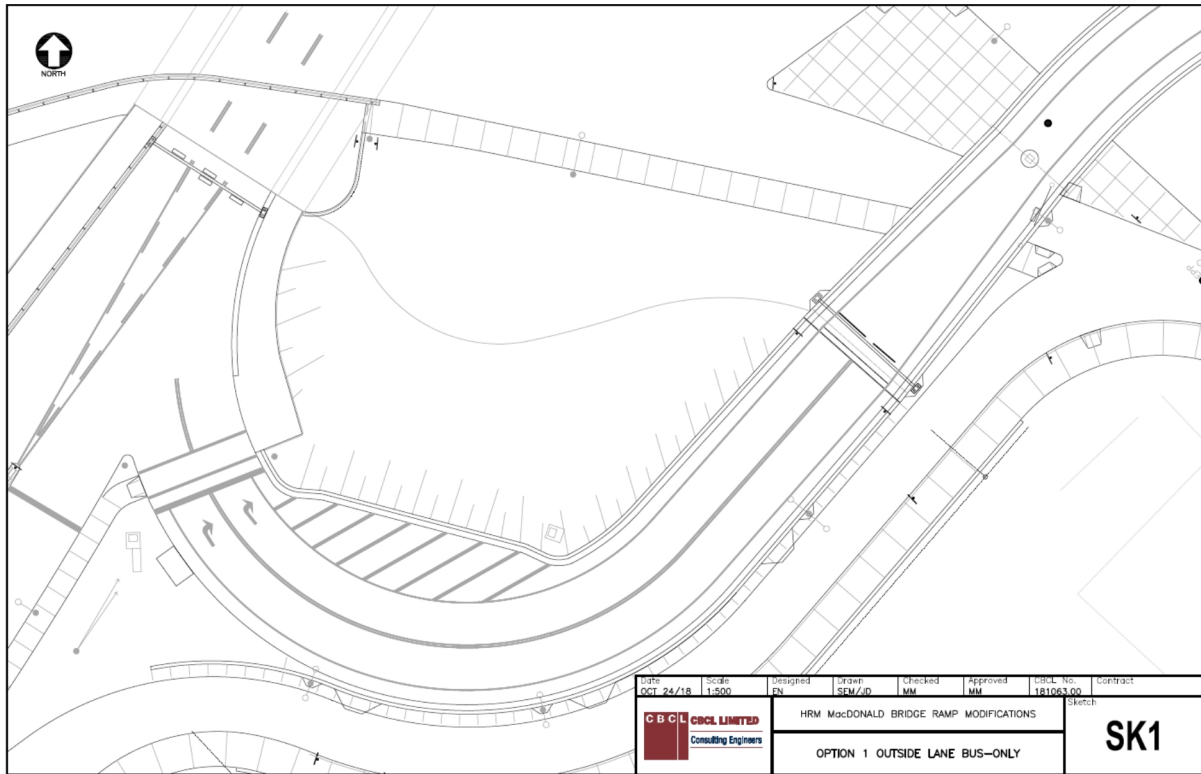

Figure 14 Option 1 – Outside Lane Bus-Only

During the AM peak hour, we propose re-allocating 7 seconds from the eastbound phase to a new transit priority phase, similar to the implementation at the North Street and Brunswick Street intersection, see Figure 15. For this mode of operation to work safely, right turns on red would be prohibited, to avoid the possibility of conflict between a bus turning during the transit phase and a vehicle turning right on red simultaneously from the right lane.



Figure 15 Proposed Transit Phase Insertion – AM Peak Hour

During the weekday PM peak hour, when two Dartmouth-bound lanes are available, both ramp lanes are open. Under the current mode of operation, buses routing via the Barrington Street on-ramp and turning on to the bridge from the left lane would be forced into the centre lane on the bridge. This would subsequently require that they merge into the right lane, which would present operational and safety concerns under current signal phasing. While both ramp lanes are open, the introduction of a bus transit phase to give buses priority over general traffic would require closure of the left lane to general traffic. Considering the importance of the eastbound flow as the major movement in the intersection, its current phase length was retained, and the proposed phase insertion re-allocated 7 seconds from the on-ramp phase, as illustrated in Figure 16.



Figure 16 Proposed Transit Phase Insertion – PM Peak Hour

Depending on service standards for bus routes executing this turn during the weekday AM peak, HRM would have the option to implement Transit Signal Priority (TSP) at this location, whereby the bus detection would pre-empt the general traffic phase from the Barrington on-ramp, and the bus would therefore not need to stop. This would only be achieved with more advanced detection measures than the ground-based induction loops currently installed used by HRM. Considering the limited space available, however, partial TSP measures may be insufficient to achieve a meaningful improvement to transit vehicle movement through the intersection.

5.2 Option 2 – Outside Lane Widening

The first modification would consist of increasing the horizontal clearance available to turning buses by reducing the pedestrian island and shifting the Barrington Street on-ramp stop bar further west, see Figure 17.

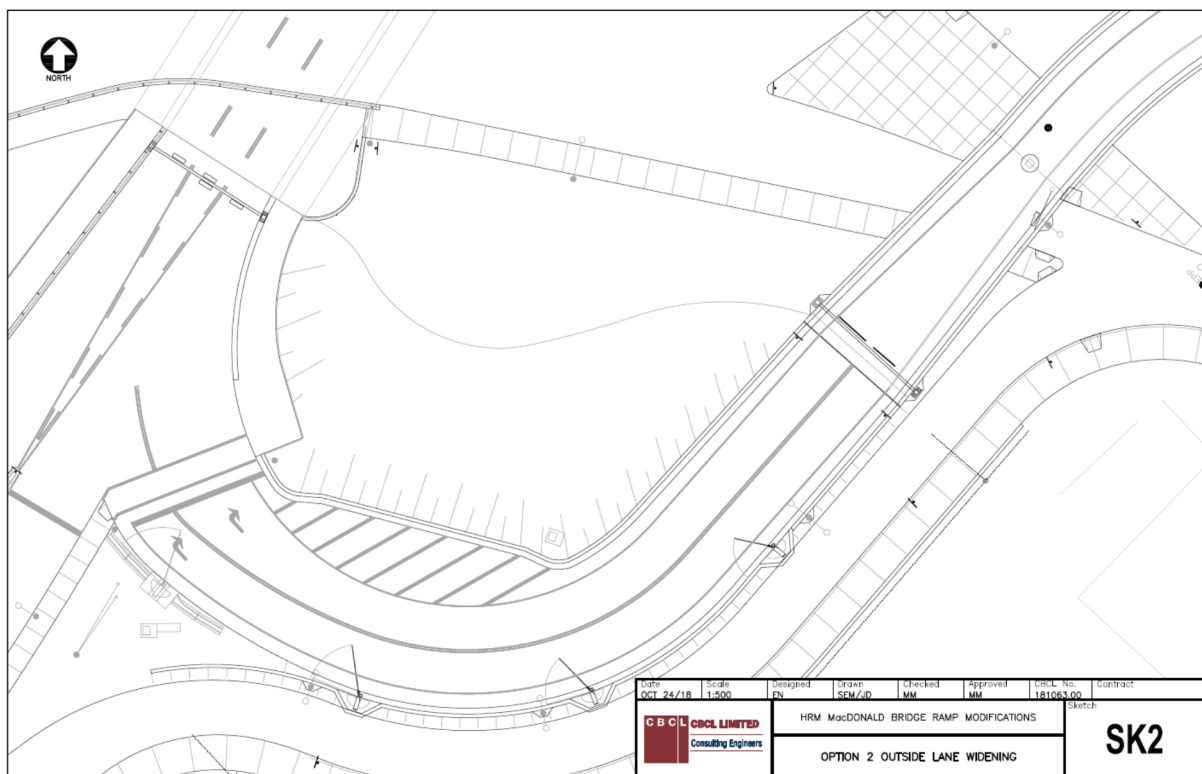

Figure 17 Option 2 –Outside Lane Widening

5.3 Option 3 – Add Outside Lane

The third option would expand on the second by widening the ramp approach on the outside curve to provide a short transit holding lane, see Figure 18. This would allow approaching buses to wait in a separate lane at the stop bar and execute a wider turn in front of general traffic to enter the bridge's right lane. This option would also require the insertion of a transit phase, as in the operational changes proposed during the weekday AM peak. As in Option 1, the lane gates currently in place along the left lane would be removed, allowing the bus to pass through to the left lane without obstruction. During the AM period the left lane would be signed as a bus-only lane, while during the PM period the lane would function as usual.

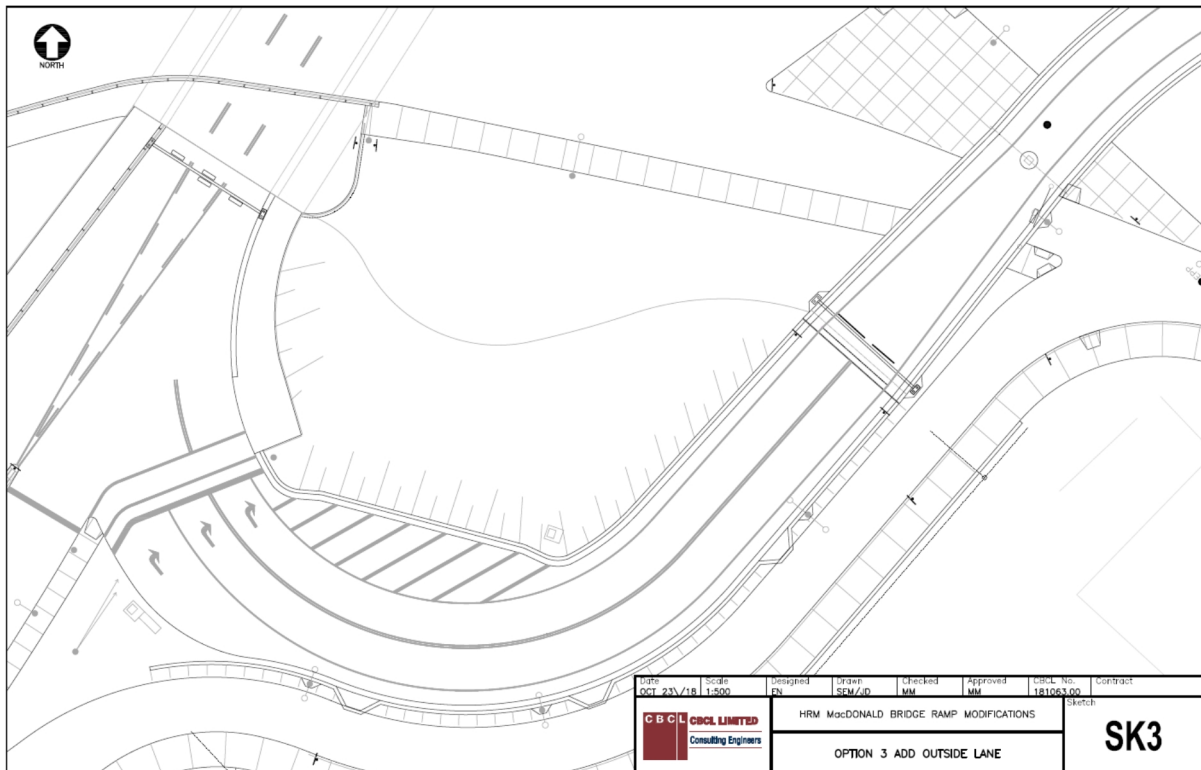

Figure 18 Option 3 – Add Outside Lane

5.4 Option 4 – Add Inside Lane

The fourth option would introduce the third lane on to the existing service area, and would require the widening of the ramp approach further east to maintain the existing service area on the inside curve of the ramp, which is used as a ship lookout by HHB. This area is indispensable to ensure safe bridge crossings when large vessels pass beneath the bridge. The new geometry would need reconstruction of the abutment on the inside curve, and possibly a new retaining wall, see Figure 19.

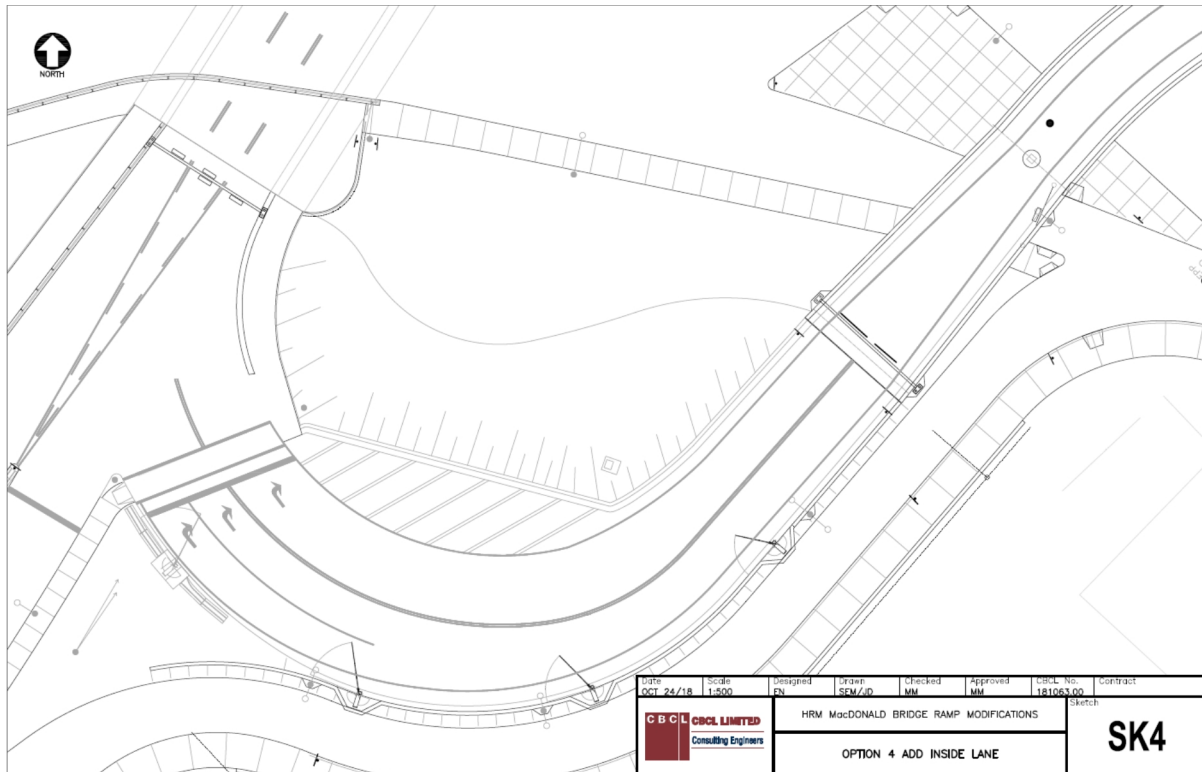

Figure 19 Option 4 – Add Inside Lane

CHAPTER 6 **OPTIONS EVALUATION**

6.1 Evaluation Criteria

The options developed and discussed in Chapter 4 and Chapter 5 were evaluated through a number of lenses:

- Improved bus turning ability;
- Impacts on pedestrian circulation;
- General vehicular traffic impacts;
- Constructability; and
- Bridge impacts.

For each option, the evaluation is summarized in Table 5 according to the options' relative satisfaction of each criterion as follows:

- Inadequate
- ◐ Poor
- ◑ Adequate
- Good
- Preferred

6.2 Bus turning ability

The Autodesk Vehicle Tracking software was used to assess buses' ability to correctly execute the right turn under each of the options proposed in Chapters 4 and 5. The results of the analysis are summarized in Table 4, and detailed outputs from the Vehicle Tracking swept-path analysis are included in Appendix C. Overall we find that, with the exception of articulated 60 foot buses turning from the inside lane, the right-turning movement is possible for all options.

The turns executed under the "Do Nothing" conditions were validated during the second field test, conducted on September 22nd, 2018. Option 2 was similarly tested on the same day, and, following discussion with the bus trainers that executed the manoeuvre, was found to provide sufficient clearance without encroaching into adjacent lanes. It was not possible to field test Options 3 and 4 with the current geometry.

Table 4 Bus Turning Movement Ability

		Do Nothing (Status Quo)	Option 1 Outside Lane Bus-Only	Option 2 Outside Lane Widening	Option 3 Add Outside Lane	Option 4 Add Inside Lane
Inside Lane Turn	40 foot	No		Yes		Yes
	60 foot	No		Yes		Yes
Outside Lane Turn	40 foot		Yes		Yes	
	60 foot		Yes		Yes	

6.3 Impacts on Pedestrian Circulation

Overall the proposed options have minor impact on pedestrian operations. While Options 2, 3 and 4 would require the lengthening of the pedestrian crossing, there would be no impact to the ability to cross the intersection, as the eastbound phase would remain long enough to accommodate sufficient extension of the pedestrian flashing - don't walk phase. These options do lengthen the crosswalk, however, extending pedestrians' exposure by requiring them to be on the crosswalk for longer periods of time.

Option 2 would lengthen the crossing from approximately 10m to 12.7m. At the same time, the ramp approach is re-oriented away from the bridge abutment. This has the effect of taking drivers' eyes away from the bridge, towards the eastbound flows on North Street, with the resulting possibility of reduced attention to pedestrians crossing the on-ramp approach westbound from the bridge.

Option 3 would lengthen the crossing to 13.7m and reduce the length of the pedestrian island slightly from 33m to 30m. This would not have any impact on the island's storage capacity and would not place pedestrians waiting to cross in any additional danger. The presence of a bus in the new left lane, however, may reduce the visibility of eastbound crossing pedestrians to vehicles stopped in the centre lane.

Option 4 would lengthen the crosswalk by 5m to a total of 15m. It would also require the re-orientation of the pedestrian sidewalk from the bridge to a tighter curve, with the result that they would approach the crossing point almost head on, facing vehicular movements from the ramp. This would increase westbound-crossing pedestrians to drivers and render their crossing safer.

We note that prohibition of right turns on red would significantly reduce the possibility of conflict between crossing pedestrians and turning vehicles under all options.

6.4 General vehicular traffic impacts

The options developed were evaluated from an operational performance perspective using the downtown Halifax Synchro model, with some parameters modified from the existing conditions review. Following discussion with HRM staff, it is understood that up to 20 buses per peak hour could re-route via the Barrington Street on-ramp to access the bridge. Vehicle movements and heavy vehicle percentages were redistributed accordingly. For the purposes of this analysis it was assumed that the impacts associated with any interventions to the geometry or operation of the ramp intersection would be localized, and that general traffic patterns would therefore persist without re-distribution from one leg of the intersection to another.

Options were evaluated with the signal timings as programmed under existing conditions, with minor modifications to accommodate a transit phase in some scenarios. The signal timings were not optimized. Considering the introduction of a transit phase in some of the proposed options to facilitate buses departing the stop bar ahead of adjacent traffic, it was furthermore decided to evaluate the intersection with prohibition of right turns on red. Review of camera footage reveals that during the PM peak, there are very few gap opportunities during the red phase to permit right turns on red from the Barrington northbound on-ramp.

Overall, the analysis found that the intersection operates at capacity under existing conditions and experiences severe delays and queue formation during the PM peak hour. While none of the proposed options bring any improvement to existing conditions, any intervention reducing the green time available to the general on-ramp vehicular traffic will have a detrimental impact on the experienced levels of service. While the Synchro/SimTraffic model is good at providing estimates of intersection capacity under static conditions, its calculations are no longer reliable when volume exceeds theoretical capacity. Discussion of Synchro performance measures for each option subsequently becomes fruitless, as they are not representative of real-life conditions. Furthermore, while SimTraffic provides a more accurate understanding of queue formation, it is still based on the assumption of a static assignment of travel demand. In reality, as vehicular demand exceeds the hourly vehicular capacity of the road network, no additional vehicles can enter the network. This condition would be felt as blockages of parking lots and garages. The net effect is of the peak conditions spreading over a longer period in the vicinity of the capacity constraint, and extending over a greater area. Since there are currently no alternatives for cross-harbour vehicular traffic, beyond a certain threshold the delays incurred at blocked access points would tend to induce a change in trip departure times, with people changing their behaviour and opting to leave either before or after the peak hour.

For the purposes of this report, we are therefore limited to note that, Options 1, 3 and 4 would extend the existing poor levels of service, long delays and long queues experienced across a longer period, to varying degrees, by occasionally re-allocating 7 seconds from the northbound phase to a transit phase. While it is known that congested conditions are experienced as far south as Cornwallis Street, the proposed green time re-allocation may induce such conditions further upstream than currently experienced. Option 1 would have an added impact during the PM period, as it would limit the on-ramp approach to a single lane for general traffic, with the outside lane being reserved for transit vehicles.

Option 2 would have no noticeable impact to operations, since it does not propose any additional changes to the lane configuration or signal timing of the intersection, beyond the restriction of right turns on red. Some minor effect may be felt by vehicles turning right from the left on-ramp lane as the turn would be slightly longer under this option.

6.5 Bridge impacts

Of the options developed above, only Option 4 has a direct impact on the bridge abutment, as it would require the movement and geometric reconfiguration of the pedestrian walkway and the ship lookout. This option would only push out the inner curve of the ramp approach by approximately 5m into what is now graded terrain, and would not have any direct impact on the bridge structure itself.

6.6 Constructability

All proposed options will require physical intervention to some degree, with associated construction impacts on the study area, as partial road closures may be required for staging or construction activities. The extent of such disruption and resulting traffic control measures would vary according to each option's requirements. Detailed drawings of each option are included in Appendix E, identifying new construction and infrastructure to be removed or relocated. We note that all proposed options would have some construction impacts.

Option 1 would require the addition of a transit signal head to the 3 traffic signals for the Barrington Street northbound on-ramp approach. Since the outside lane would become a transit lane only, the lane gates would have to be removed (see Figure 20).

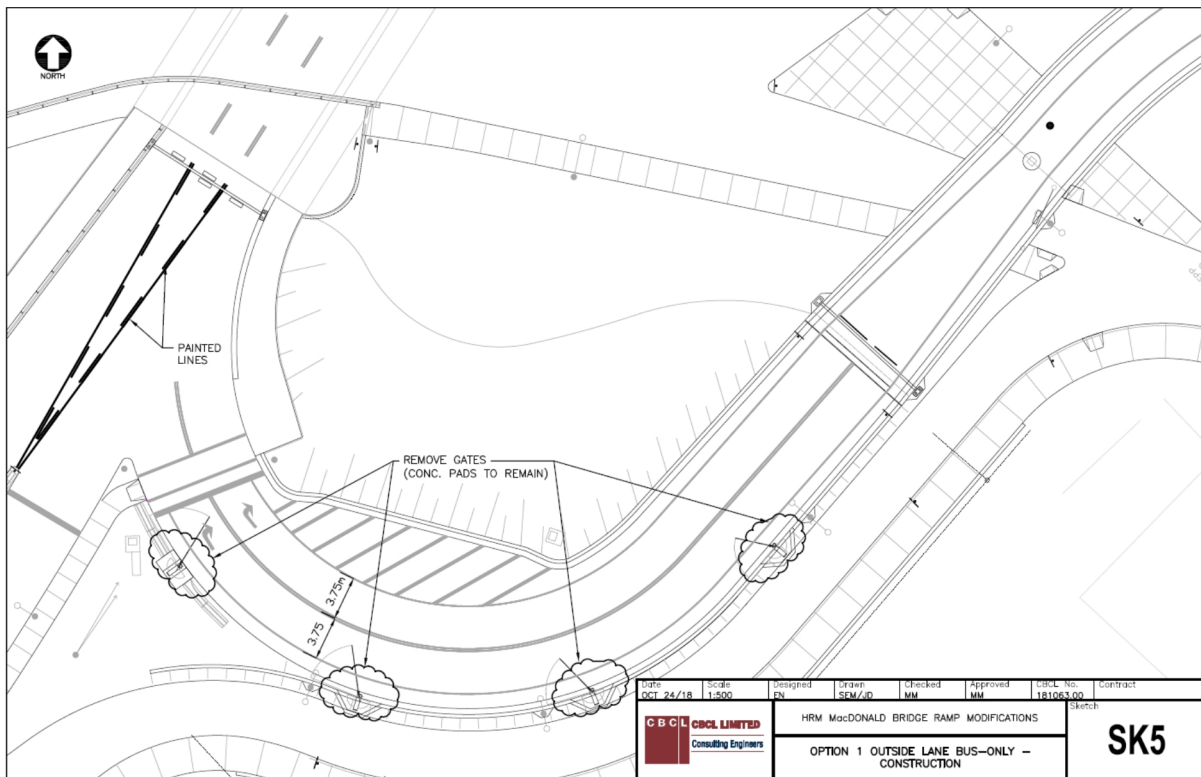

Figure 20 Option 1 – Construction of Outside Lane Bus-Only

Option 2, would require the removal and relocation of the eastbound traffic signal pole on North Street, the controller cabinet, a bench and the northernmost lane gate currently installed along the south (outside) edge of the on-ramp approach (see Figure 21). The light pole and utility pole guy wires may also be impacted (see Figure 22). Since these features must be relocated following removal, they will require additional construction and cost.

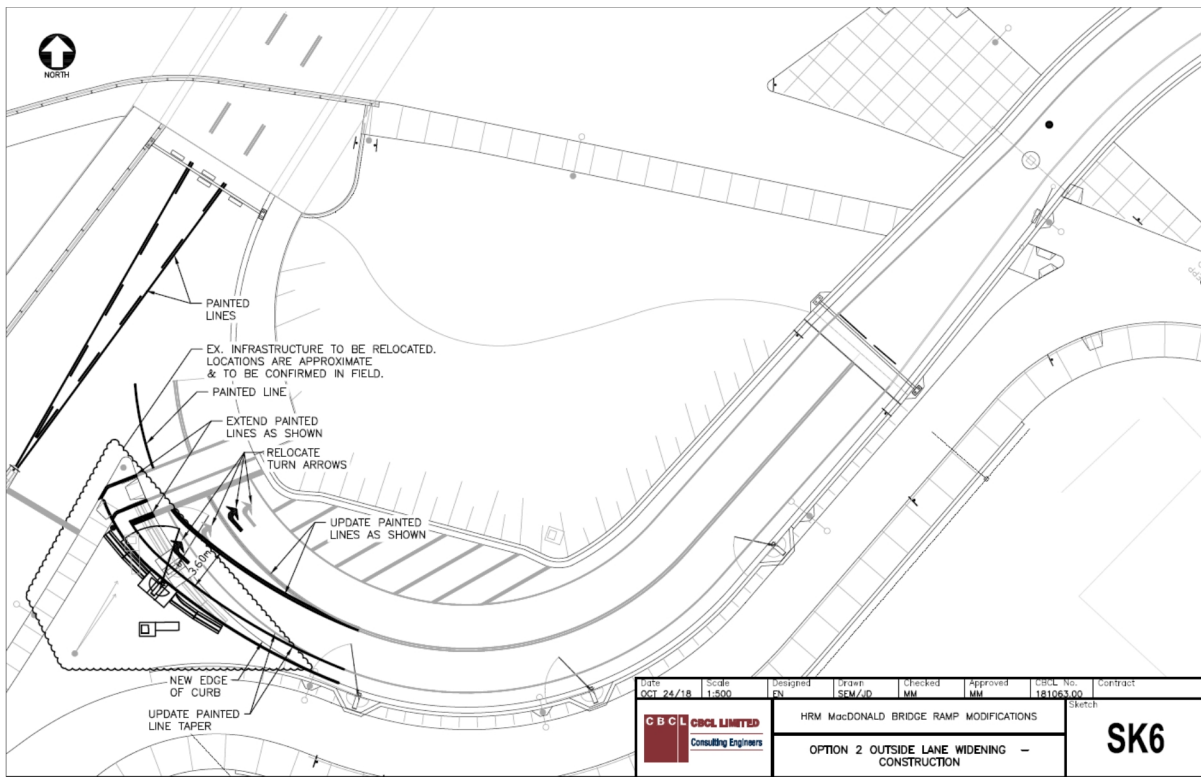

Figure 21 Option 2 – Construction of Outside Lane Widening



Figure 22 Items to be Relocated/Removed for Options 2, 3, and 4

Under Option 3, buses would require access to the new outside lane at all times. The lane gates currently installed along the south (outside) edge of the on-ramp approach would therefore need to be removed (see Figure 23 and Figure 24), their function being replaced by variable signage on the overhead gantry, indicating that the lane is reserved for buses only during the AM period. Since these features will only be removed, not replaced, the associated construction effort and cost would be less than under Option 2.

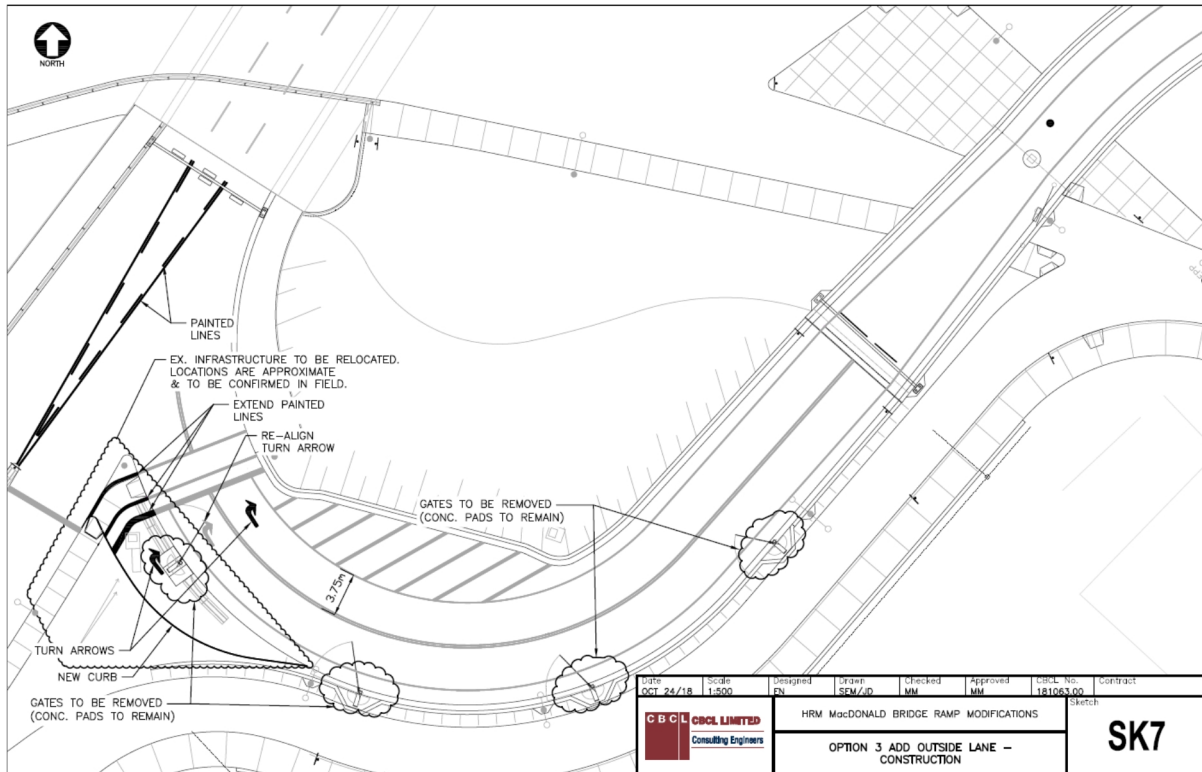

Figure 23 Option 3 – Construction of Additional Outside Lane



Figure 24 Existing Gates along Outside of Ramp

Option 4 would require the relocation of the east traffic signal for the on-ramp approach, and the reconfiguration of the pedestrian walkway approach, in addition to the removals and relocations required under Option 3. Widening on the inside curve of the ramp approach would require the construction of a concrete platform on pillars tied back to the existing structure, with the relocation of the lane gate controller cabinet and regrading of the embankment to sustain the new ship lookout extension (see Figure 25).

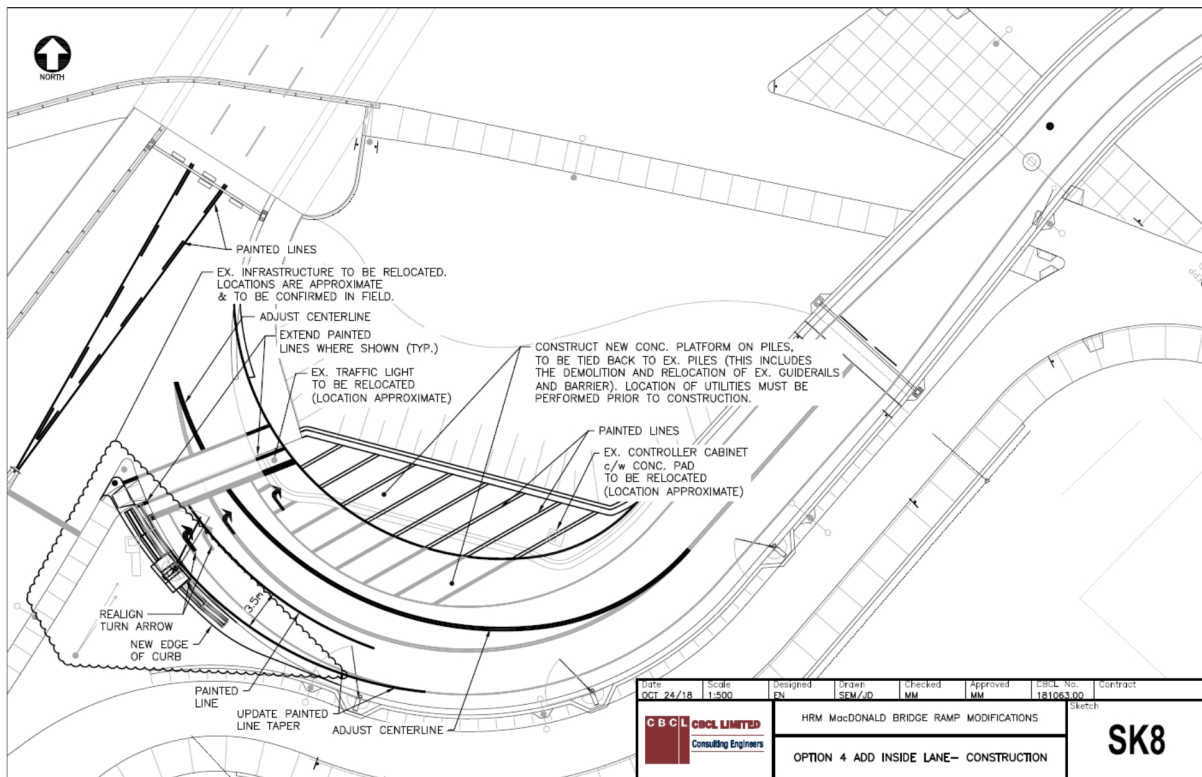

Figure 25 Option 4 – Construction of Additional Inside lane

6.7 Cost estimates

CBCL has developed an opinion of probable costs for the four options presented in this report. Costs, which include mobilisation of general contractors, removal and relocation of existing features and utilities, and construction of new infrastructure, are summarized for each option in Appendix F.

Overall, Option 1 appears as the least costly (\$63,000), as it does not require any reconstruction, only the addition of transit phase modules to the three existing signal heads servicing the on-ramp approach. This can be achieved using the existing electrical conduits, without additional infrastructure.

Option 2 would require the relocation of a number of utilities and infrastructure within the pedestrian island and would cost \$251,000. This option would require the removal and the relocation of the lane gate closest to the intersection, with the associated construction costs of a new gate base, and new electrical conduits.

Option 3 would be slightly less expensive than Option 2, at \$221,000, since, aside from the relocation of utilities and infrastructure within the pedestrian island, it would only require the removal of the gates and capping of the electrical conduits, not their replacement at a different location.

Option 4, requiring the most significant reconstruction and relocation of existing infrastructure, could cost upwards of \$685,000.

Table 5 Option Evaluation Matrix

Option	Do Nothing (Status Quo)	Option 1 Outside Lane Bus- Only	Option 2 Outside Lane Widening	Option 3 Add Outside Lane	Option 4 Add Inside Lane
Improved Bus Turning Ability	○ Neither 40 foot nor 60 foot buses can turn	● Both buses can turn from left lane	● Both buses can turn from inside lane	● All buses can turn from new left lane but 60 foot buses exceed lane storage length slightly	● Both buses can turn from new inside lane
Impacts on Active Transportation	● No additional impacts on pedestrian circulation	● No additional impacts on pedestrian circulation	● Minor impact on pedestrian crossing safety, mitigated by prohibition of right turns on red	● Minor impact on pedestrian crossing, mitigated by prohibition of right turns on red	● Minor impact on pedestrian crossing, mitigated by prohibition of right turns on red
General Vehicular Impacts	● No additional impacts on Barrington ramp	○ No additional impact on general traffic during the AM peak hour, but significant impact on capacity during the PM peak hour	● Very minor impact on general traffic	○ Significant impact during the PM peak hour as the intersection already functions close to or at capacity under existing conditions	○ Significant impact during the PM peak hour as the intersection already functions close to or at capacity under existing conditions
Bridge Impacts	● No additional impacts on the bridge structure	● No additional impacts on the bridge structure	● No additional impacts on the bridge structure	● No additional impacts on the bridge structure	◐ Significant reconstruction of berm of bridge abutment
Constructability	● No construction required	● No construction required. Additional signal head required.	◐ Limited reconstruction of pedestrian island required.	◐ Major reconstruction of pedestrian island required. Additional signal head required.	○ Limited reconstruction of pedestrian island required. Major reconstruction of ship lookout required.
Cost	● No additional costs involved	● \$63,000	◐ \$251,000	◐ \$221,000	○ \$685,000

CHAPTER 7 CONCLUSION

The analysis summarized above confirms that the status quo is not a viable option, as it does not satisfy HRM's need to accommodate right-turning buses from the Barrington Street northbound on-ramp.

Options 1, 2, and 4 are preferred in terms of their ability to accommodate the bus turns. Option 3 works, but cannot fully store the 60 foot articulated buses within the proposed slip-lane.

All options have minor impacts on pedestrian circulation, provided right turns on red are prohibited, and are relatively equally well rated.

Options 1, 3, and 4 incur unacceptable impacts on existing traffic conditions.

Option 4 would require significant reconstruction of the ship lookout with some impact on the bridge abutment.

Option 1 is preferred in terms of constructability, with Option 2 requiring some limited reconstruction of the Pedestrian Island, and associated utility and infrastructure relocation.

Option 1 is preferred in terms of costs as the least costly alternative. Options 2 and 3 are relatively equally priced, while Option 4 is least preferred.

7.1 Recommendation

Based on the above, we consider that Option 2 is the best option to be carried forward. It satisfies the requirement that 40 foot and 60 foot buses be able to safely execute the right-turn movement from the on-ramp inside lane to the right bridge lane, while having the least impact on general vehicular traffic operations, as it does not propose any changes to current operations or lane configuration. While it is not the least expensive alternative, it has acceptable impacts on general traffic operations and active transportation through the intersection. It also has relatively minor constructability constraints, requiring minimal reduction of the pedestrian crosswalk and the relocation of a lane gate.



Prepared by:
Emanuel Nicolescu, RPP, MCIP
Transportation Planner

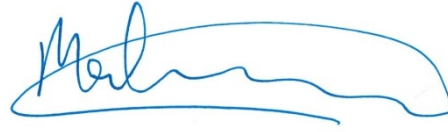

Reviewed by:
Mark MacDonald, P.Eng.
Senior Transportation Engineer

This document was prepared for the party indicated herein. The material and information in the document reflects CBCL Limited's opinion and best judgment based on the information available at the time of preparation. Any use of this document or reliance on its content by third parties is the responsibility of the third party. CBCL Limited accepts no responsibility for any damages suffered as a result of third party use of this document.

APPENDIX A

HRM - Bus Vehicle Swept-Path AutoTurn Analysis

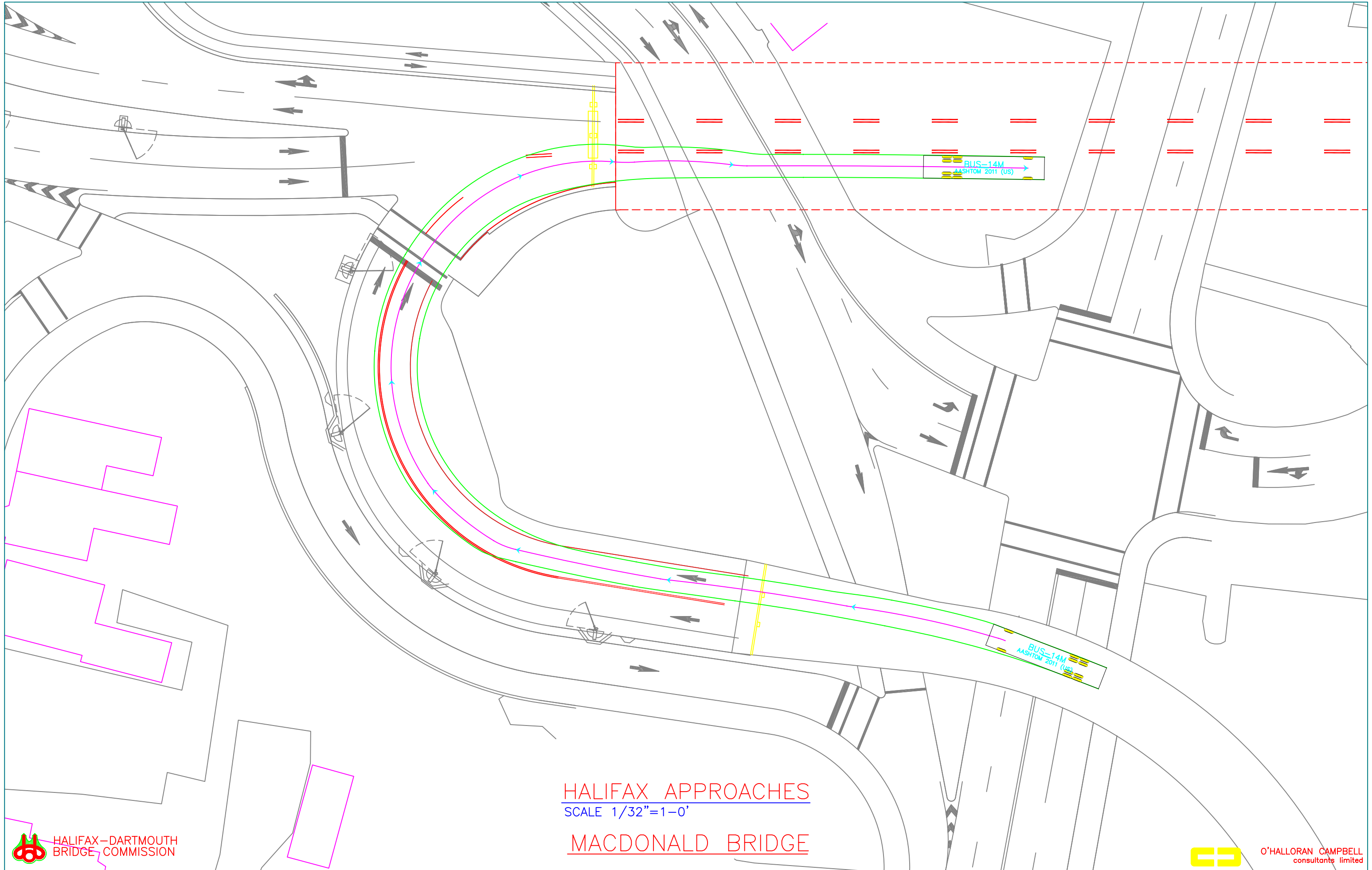

HALIFAX APPROACHES
SCALE 1/32"=1-0'
MACDONALD BRIDGE

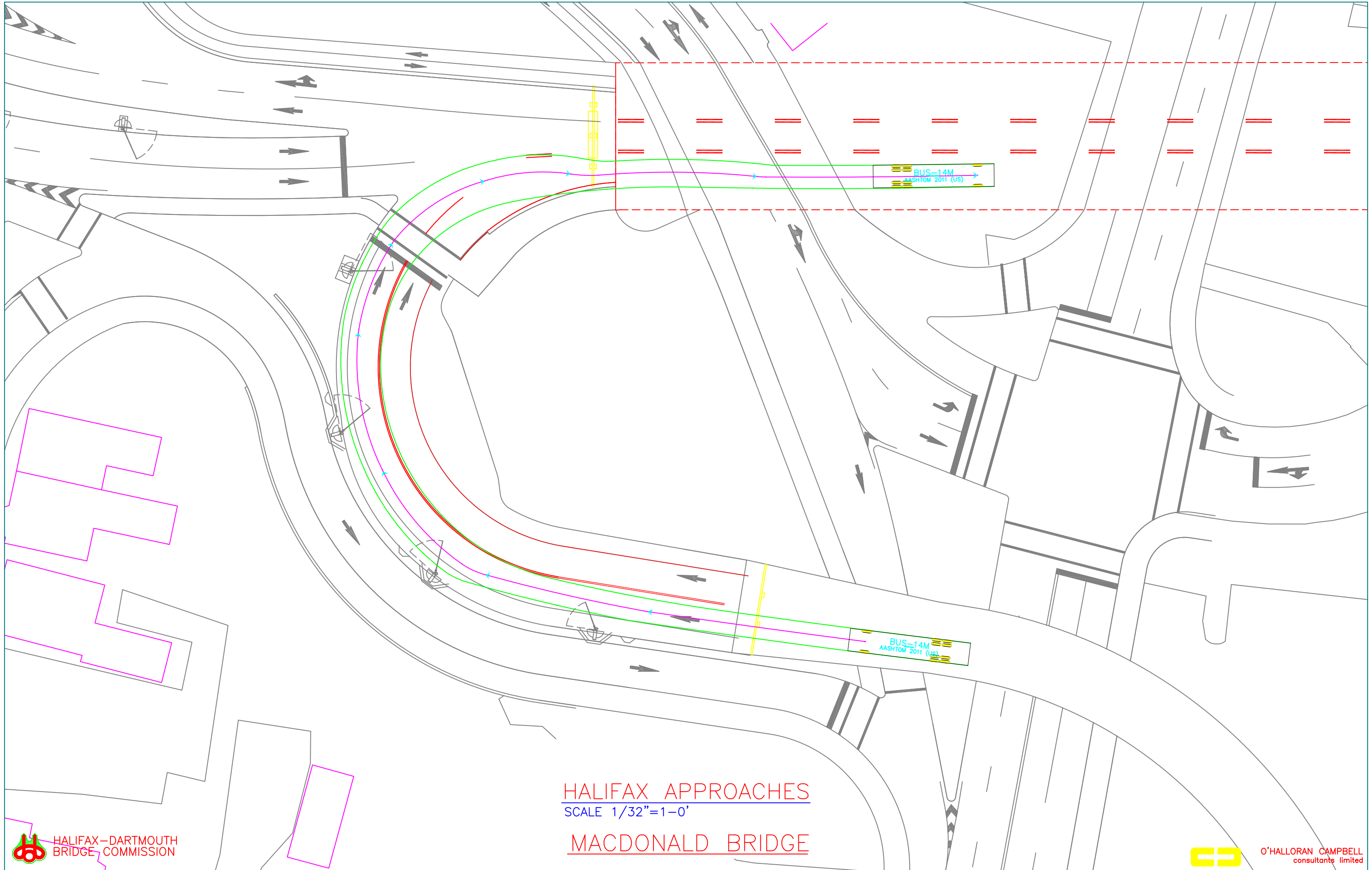

HALIFAX APPROACHES
 SCALE 1/32"=1-0'
 MACDONALD BRIDGE

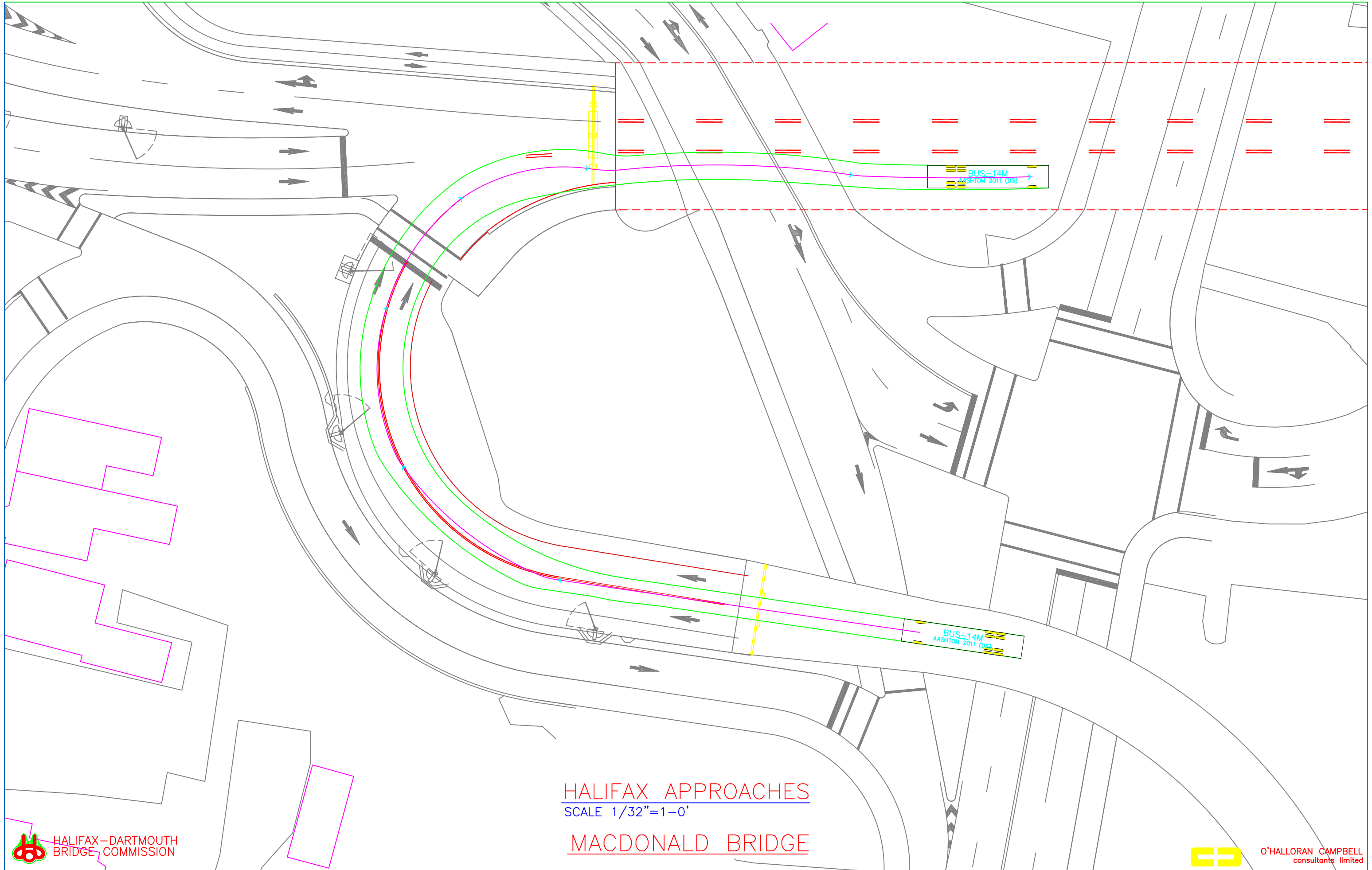

HALIFAX APPROACHES
 SCALE 1/32"=1-0'
 MACDONALD BRIDGE

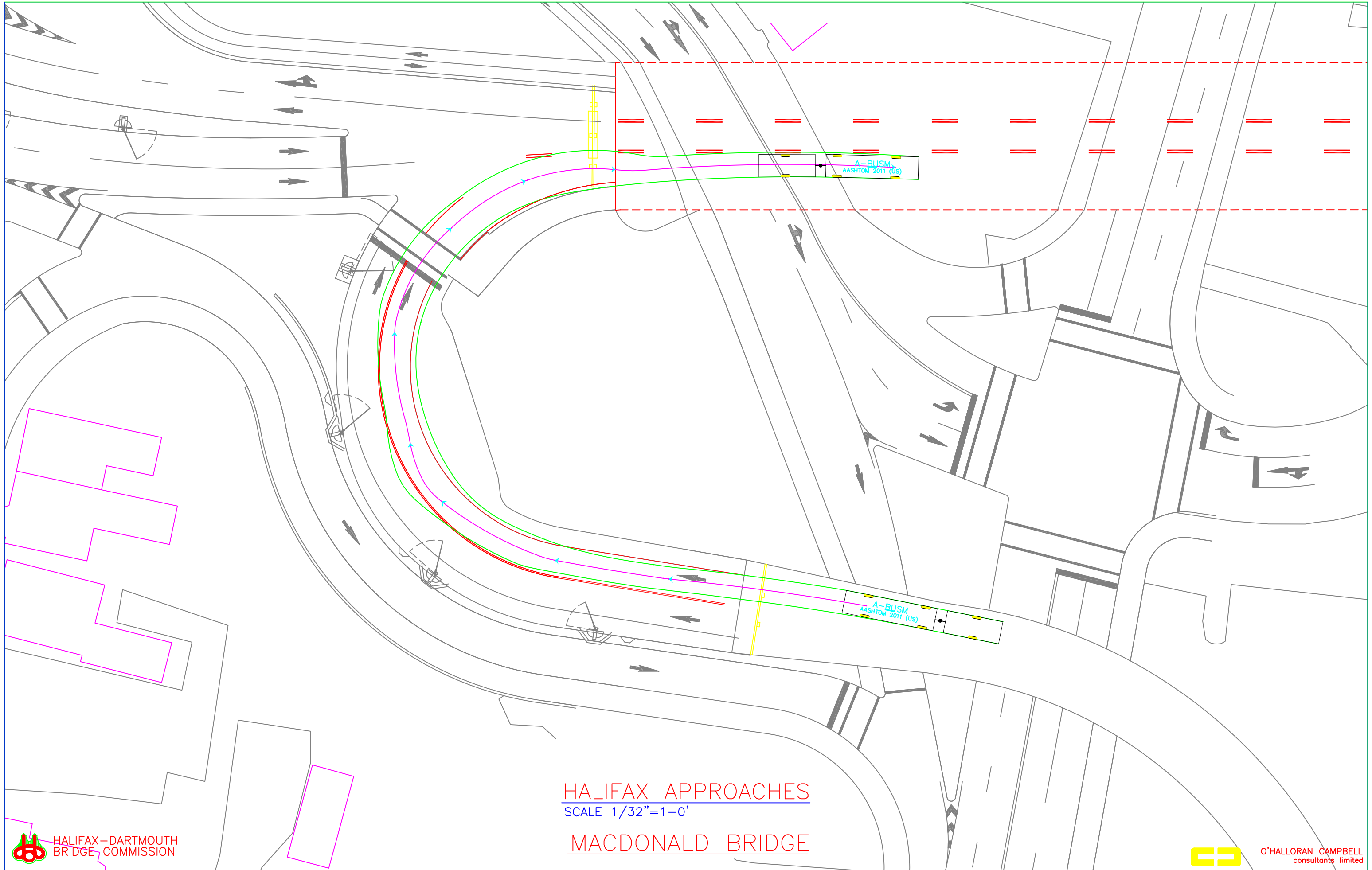

HALIFAX APPROACHES
SCALE 1/32"=1-0'
MACDONALD BRIDGE

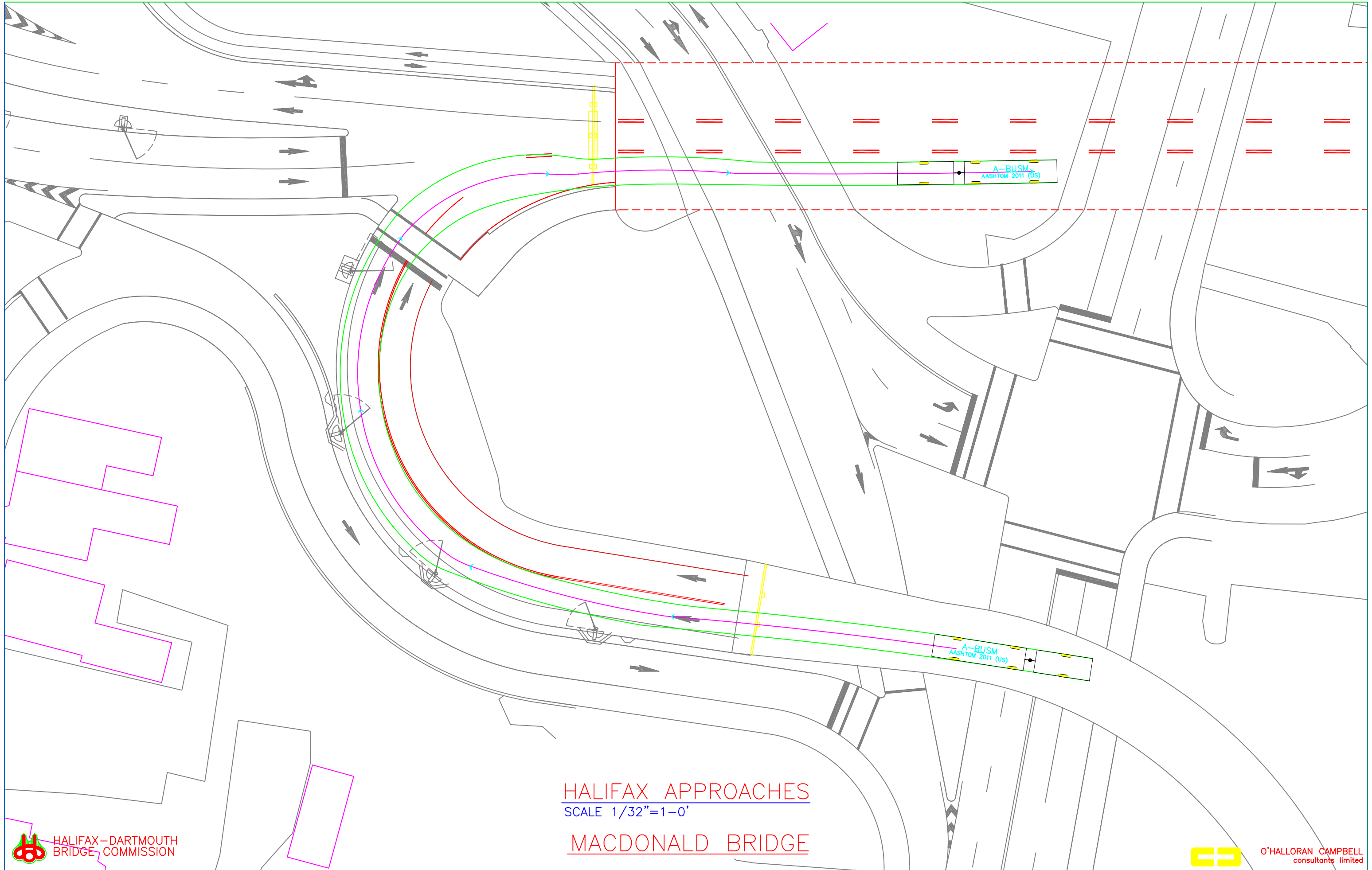

HALIFAX APPROACHES
SCALE 1/32"=1-0'
MACDONALD BRIDGE

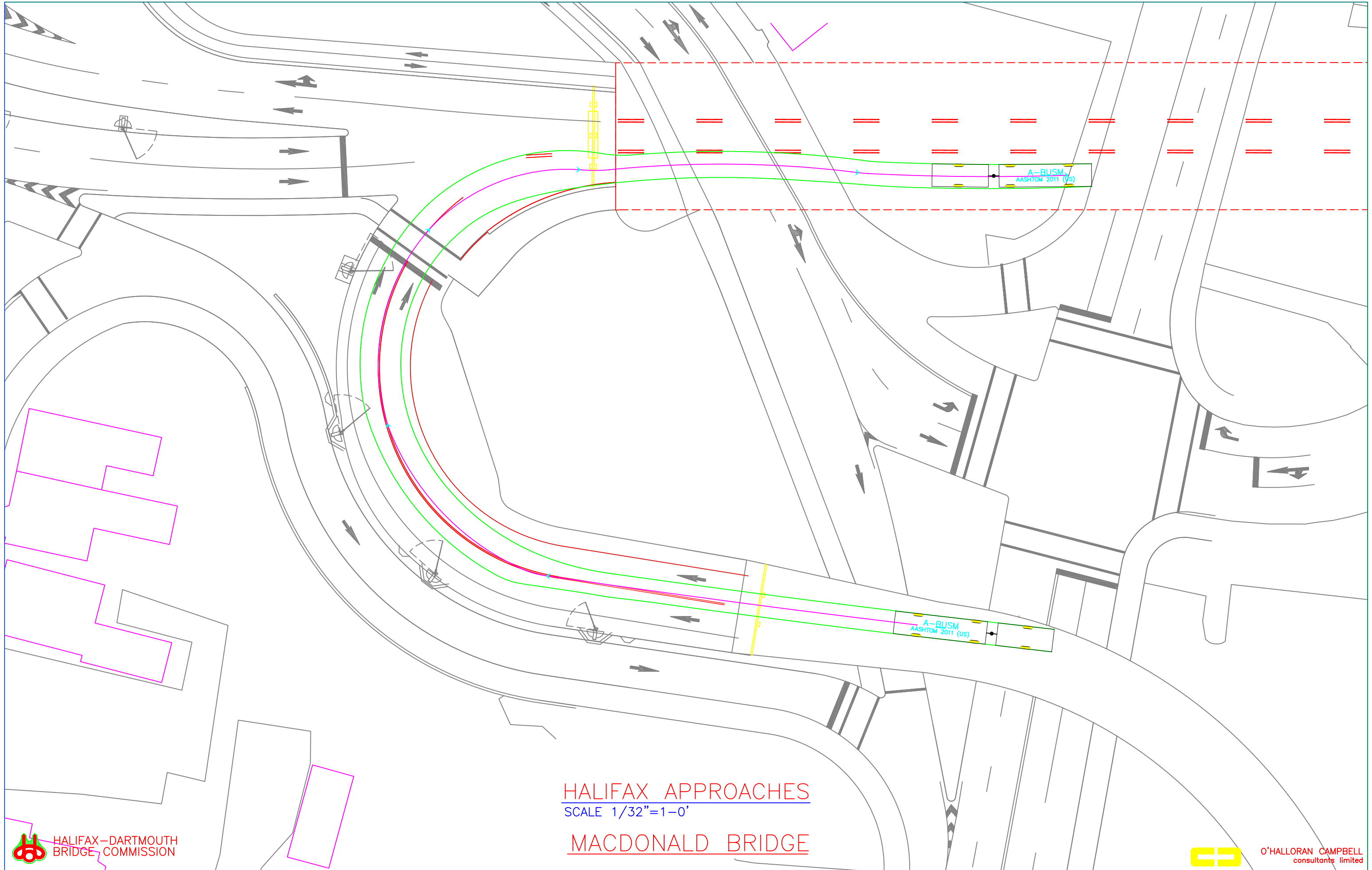

HALIFAX APPROACHES
 SCALE 1/32"=1-0'
 MACDONALD BRIDGE

APPENDIX B

HRM - North St. / Barrington St. Ramp Count Aug30-18

Study Name MACDONALD BRIDGE DARTMOUTH BOUND

Start Date 08/30/2018

Start Time 5:30 AM

Site Code 18RQ277

Channel Direction	Lane 1	Lane 2	Lane 1	Lane 2	All Lanes
	Westbound	Westbound	Eastbound	Eastbound	Both Directions
5:30 AM	72	28	44	0	144
5:45 AM	86	40	46	0	172
6:00 AM	139	61	58	0	258
6:15 AM	213	78	90	0	381
6:30 AM	309	142	125	0	576
6:45 AM	347	156	137	0	640
7:00 AM	353	171	190	0	714
7:15 AM	334	195	217	0	746
7:30 AM	388	183	245	0	816
7:45 AM	355	144	230	0	729
8:00 AM	326	126	237	0	689
8:15 AM	345	162	268	0	775
8:30 AM	346	124	263	0	733
8:45 AM	286	131	265	0	682
9:00 AM	302	113	235	0	650
9:15 AM	219	88	278	0	585
9:30 AM	211	94	332	0	637
9:45 AM	232	94	340	0	666
10:00 AM	184	68	317	0	569
10:15 AM	184	63	271	0	518
10:30 AM	217	85	291	0	593
10:45 AM	218	103	294	0	615
11:00 AM	208	75	305	0	588
11:15 AM	190	70	316	0	576
11:30 AM	229	88	300	0	617
11:45 AM	245	38	319	13	615
12:00 PM	266	0	229	100	595
12:15 PM	337	0	228	100	665
12:30 PM	283	0	203	90	576
12:45 PM	331	0	199	77	607
1:00 PM	305	0	216	84	605
1:15 PM	299	0	238	82	619
1:30 PM	279	0	226	99	604
1:45 PM	277	0	223	128	628
2:00 PM	275	0	262	117	654
2:15 PM	282	0	263	118	663
2:30 PM	309	0	256	139	704

Study Name MACDONALD BRIDGE DARTMOUTH BOUND

Start Date 08/30/2018

Start Time 5:30 AM

Site Code 18RQ277

Channel Direction	Lane 1	Lane 2	Lane 1	Lane 2	All Lanes
	Westbound	Westbound	Eastbound	Eastbound	Both Directions
2:45 PM	292	0	265	134	691
3:00 PM	277	0	297	192	766
3:15 PM	289	0	294	197	780
3:30 PM	312	0	323	245	880
3:45 PM	315	0	323	244	882
4:00 PM	303	0	266	273	842
4:15 PM	331	0	226	284	841
4:30 PM	330	0	228	278	836
4:45 PM	337	0	224	273	834
5:00 PM	354	0	263	258	875
5:15 PM	345	0	250	236	831
5:30 PM	338	0	274	175	787
5:45 PM	275	0	202	115	592
6:00 PM	281	0	249	101	631
6:15 PM	287	0	194	98	579
6:30 PM	291	0	203	81	575
6:45 PM	255	0	188	78	521
7:00 PM	204	0	218	65	487
7:15 PM	191	0	205	43	439
7:30 PM	195	0	194	19	408
7:45 PM	174	0	148	22	344
TOTAL	15757	2720	13590	4558	36625
FACTORED	16072	2774	13862	4649	37358

Study Name NORTH ST. ONTO MACDONALD BRIDGE

Start Date 08/30/2018

Start Time 5:30 AM

Site Code 18RQ278

Channel Direction	Lane 1	Lane 2	Both Lanes 2
	Eastbound	Eastbound	Eastbound
5:30 AM	21	0	21
5:45 AM	22	0	22
6:00 AM	32	0	32
6:15 AM	48	0	48
6:30 AM	79	0	79
6:45 AM	103	0	103
7:00 AM	127	0	127
7:15 AM	132	0	132
7:30 AM	151	0	151
7:45 AM	140	0	140
8:00 AM	136	0	136
8:15 AM	171	0	171
8:30 AM	155	0	155
8:45 AM	157	0	157
9:00 AM	138	0	138
9:15 AM	177	0	177
9:30 AM	221	0	221
9:45 AM	239	0	239
10:00 AM	212	0	212
10:15 AM	172	0	172
10:30 AM	181	0	181
10:45 AM	178	0	178
11:00 AM	172	0	172
11:15 AM	204	0	204
11:30 AM	186	0	186
11:45 AM	193	0	193
12:00 PM	127	76	203
12:15 PM	135	65	200
12:30 PM	117	59	176
12:45 PM	118	64	182
1:00 PM	120	62	182
1:15 PM	128	50	178
1:30 PM	137	71	208
1:45 PM	124	88	212
2:00 PM	142	83	225
2:15 PM	137	78	215
2:30 PM	155	80	235

Study Name NORTH ST. ONTO MACDONALD BRIDGE

Start Date 08/30/2018

Start Time 5:30 AM

Site Code 18RQ278

Channel Direction	Lane 1	Lane 2	Both Lanes 2
	Eastbound	Eastbound	Eastbound
2:45 PM	157	85	242
3:00 PM	163	123	286
3:15 PM	170	115	285
3:30 PM	192	130	322
3:45 PM	176	150	326
4:00 PM	145	151	296
4:15 PM	103	160	263
4:30 PM	120	156	276
4:45 PM	123	156	279
5:00 PM	141	162	303
5:15 PM	123	128	251
5:30 PM	137	102	239
5:45 PM	107	67	174
6:00 PM	138	48	186
6:15 PM	92	69	161
6:30 PM	106	59	165
6:45 PM	96	44	140
7:00 PM	122	37	159
7:15 PM	113	20	133
7:30 PM	122	0	122
7:45 PM	98	1	99
TOTAL	7931	2739	10670
FACTORED	8090	2794	10883
18.5 HOUR SURVEY			

Study Name BARRINGTON ST RAMP ONTO MACDONALD BRIDGE

Start Date 08/30/2018

Start Time 5:30 AM

Site Code 18RQ279

Channel	Lane 1	Lane 2	Both Lanes
Direction	Eastbound	Eastbound	Eastbound
5:30 AM	23	0	23
5:45 AM	25	0	25
6:00 AM	26	0	26
6:15 AM	32	0	32
6:30 AM	46	0	46
6:45 AM	39	0	39
7:00 AM	57	0	57
7:15 AM	88	0	88
7:30 AM	92	0	92
7:45 AM	96	0	96
8:00 AM	96	0	96
8:15 AM	96	0	96
8:30 AM	110	0	110
8:45 AM	111	0	111
9:00 AM	93	0	93
9:15 AM	99	0	99
9:30 AM	105	0	105
9:45 AM	103	0	103
10:00 AM	105	0	105
10:15 AM	104	0	104
10:30 AM	100	0	100
10:45 AM	122	0	122
11:00 AM	133	0	133
11:15 AM	112	0	112
11:30 AM	116	0	116
11:45 AM	122	3	125
12:00 PM	107	26	133
12:15 PM	94	31	125
12:30 PM	87	26	113
12:45 PM	82	19	101
1:00 PM	97	26	123
1:15 PM	108	23	131
1:30 PM	95	31	126
1:45 PM	98	37	135
2:00 PM	119	37	156
2:15 PM	131	38	169
2:30 PM	101	57	158

Study Name BARRINGTON ST RAMP ONTO MACDONALD BRIDGE

Start Date 08/30/2018

Start Time 5:30 AM

Site Code 18RQ279

Channel	Lane 1	Lane 2	Both Lanes
Direction	Eastbound	Eastbound	Eastbound
2:45 PM	113	45	158
3:00 PM	131	77	208
3:15 PM	128	76	204
3:30 PM	138	113	251
3:45 PM	149	98	247
4:00 PM	129	124	253
4:15 PM	123	115	238
4:30 PM	109	128	237
4:45 PM	100	119	219
5:00 PM	126	103	229
5:15 PM	122	112	234
5:30 PM	139	76	215
5:45 PM	97	48	145
6:00 PM	118	52	170
6:15 PM	107	24	131
6:30 PM	95	23	118
6:45 PM	97	34	131
7:00 PM	97	26	123
7:15 PM	86	24	110
7:30 PM	80	17	97
7:45 PM	64	15	79
TOTAL	5718	1803	7521
FACTORED	5832	1839	7671

APPENDIX C

Potential Solutions

DRAWING NAME: K:\PROJECTS\181063.00 HRM MACDONALD BRIDGE RAMP MODIFICATIONS\20 CAD\01 CIVIL\181063_BUSTRACKING_OPTION_1_POST.DWG LAYOUT NAME: OPTION 1 PLOT DATE: October-24-18 3:04:04 PM CAD OPERATOR: JDUCET

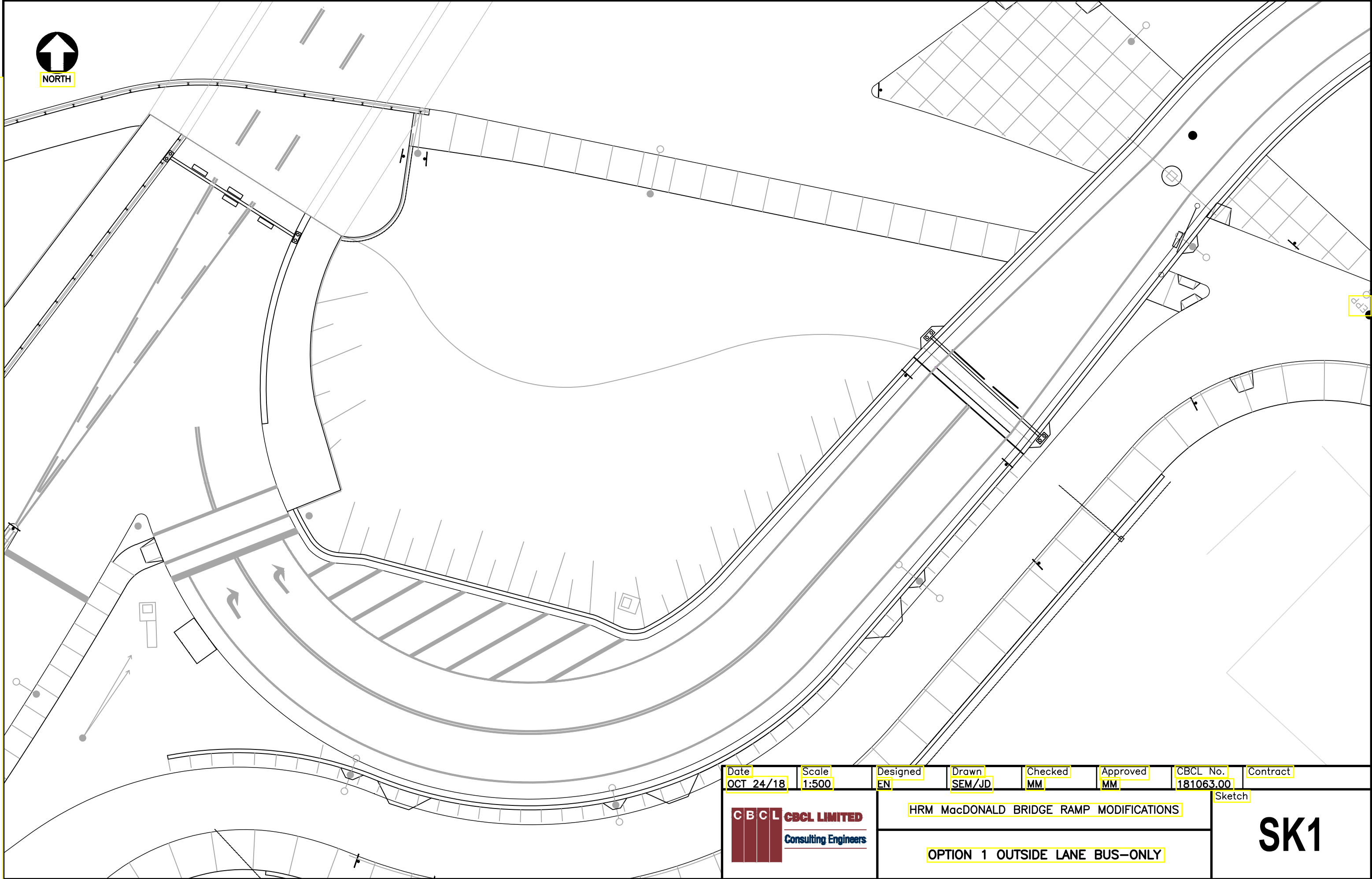

Date	Scale	Designed	Drawn	Checked	Approved	CBCL No.	Contract
OCT 24/18	1:500	EN	SEM/JD	MM	MM	181063.00	
 CBCL LIMITED Consulting Engineers		HRM MacDONALD BRIDGE RAMP MODIFICATIONS				Sketch	
		OPTION 1 OUTSIDE LANE BUS-ONLY				<h1>SK1</h1>	

DRAWING NAME: K:\PROJECTS\181063.00 HRM MACDONALD BRIDGE RAMP MODIFICATIONS\20 CAD\01 CIVIL\181063_BUSTRACKING_OPTION 2_POST.DWG LAYOUT NAME: OPTION 2 PLOT DATE: October-24-18 3:05:20 PM CAD OPERATOR: JDUCJET

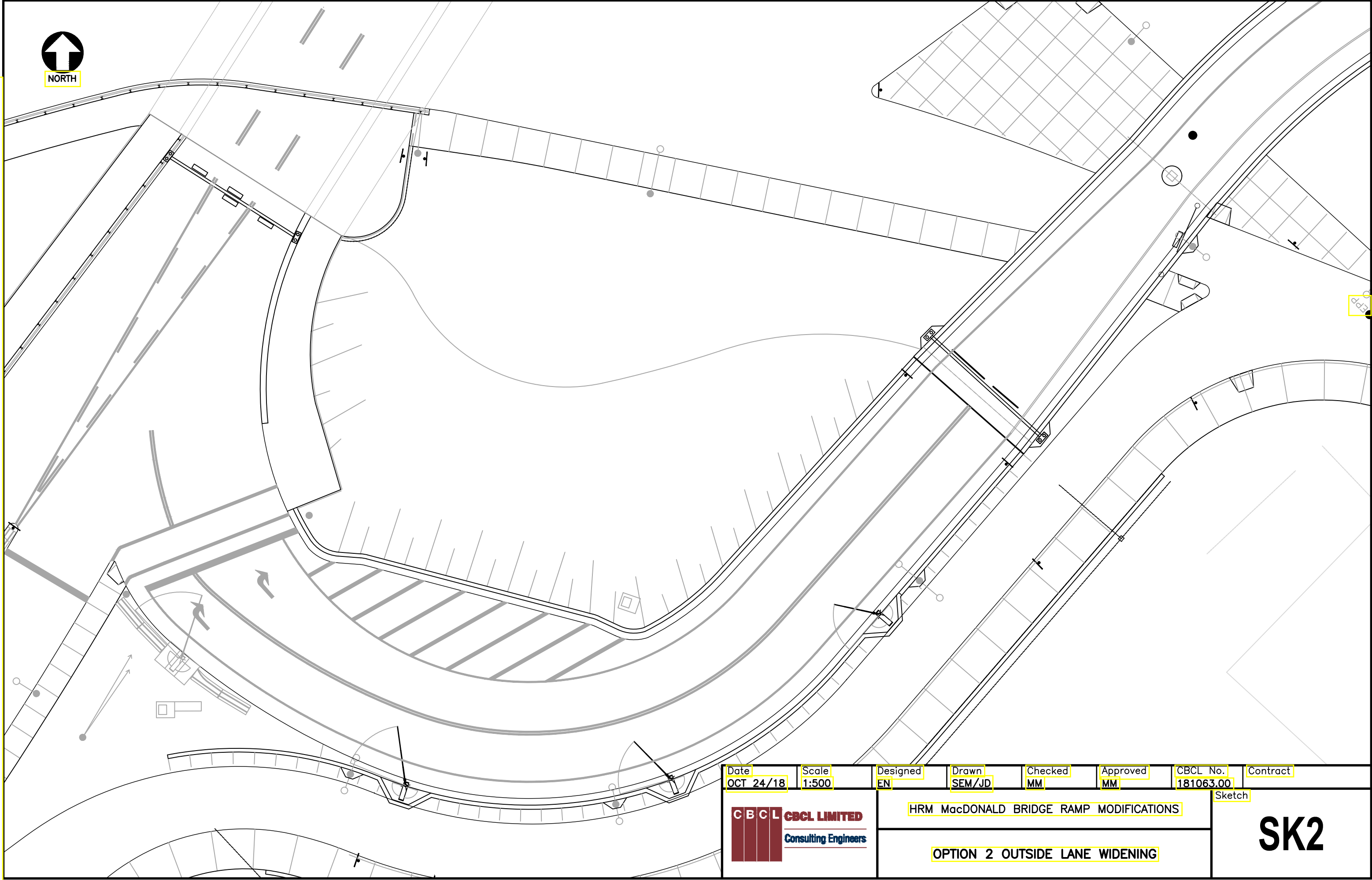

Date	Scale	Designed	Drawn	Checked	Approved	CBCL No.	Contract
OCT 24/18	1:500	EN	SEM/JD	MM	MM	181063.00	
 CBCL LIMITED Consulting Engineers		HRM MacDONALD BRIDGE RAMP MODIFICATIONS				Sketch	
		OPTION 2 OUTSIDE LANE WIDENING				SK2	



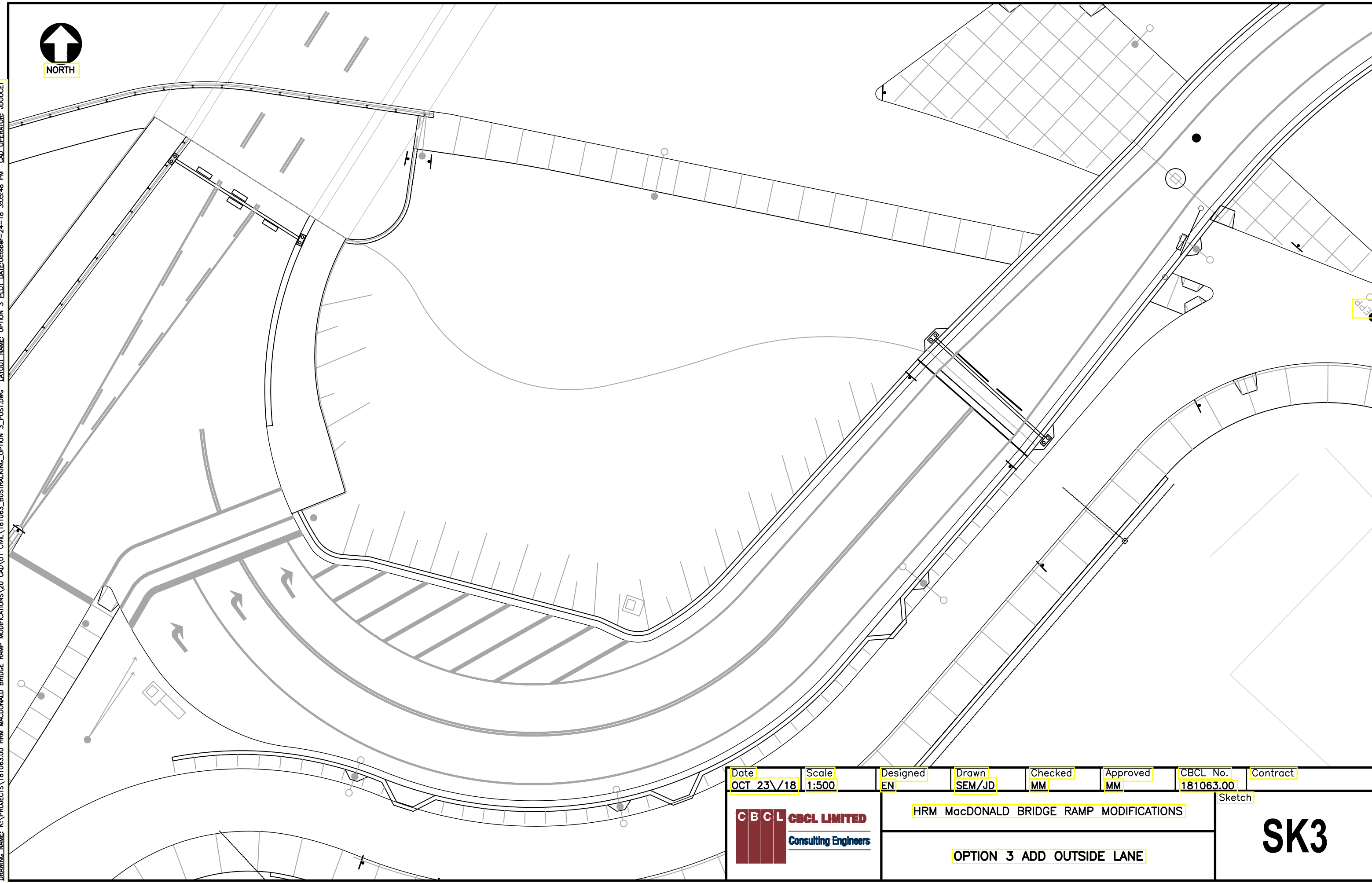

DRAWING NAME: K:\PROJECTS\181063.00 HRM MACDONALD BRIDGE RAMP MODIFICATIONS\20 CAD\01 CIVIL\181063_BUSTRACKING_OPTION_3_POST.DWG LAYOUT NAME: OPTION 3 PLOT DATE: October-24-18 3:05:48 PM CAD OPERATOR: JDOUCET

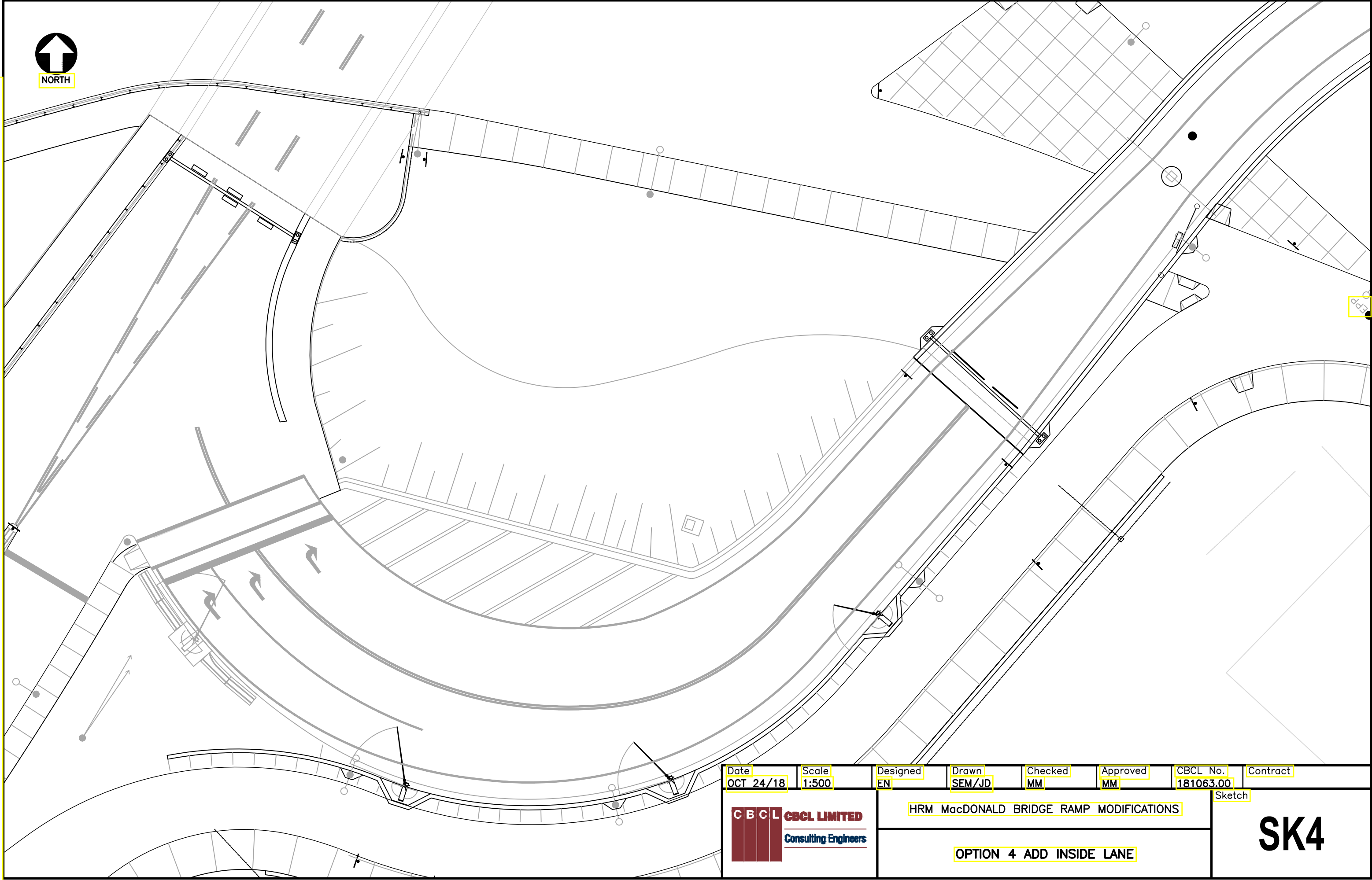

Date	Scale	Designed	Drawn	Checked	Approved	CBCL No.	Contract
OCT 23\18	1:500	EN	SEM/JD	MM	MM	181063.00	
 CBCL LIMITED Consulting Engineers		HRM MacDONALD BRIDGE RAMP MODIFICATIONS				Sketch	
OPTION 3 ADD OUTSIDE LANE				SK3			

DRAWING NAME: K:\PROJECTS\181063.00 HRM MACDONALD BRIDGE RAMP MODIFICATIONS\20 CAD\01 CIVIL\181063_BUSTRACKING_OPTION_4_POST.DWG LAYOUT NAME: OPTION 4 PLOT DATE: October-24-18 3:06:32 PM CAD OPERATOR: JDOUCET



Date	Scale	Designed	Drawn	Checked	Approved	CBCL No.	Contract
OCT 24/18	1:500	EN	SEM/JD	MM	MM	181063.00	
 CBCL LIMITED Consulting Engineers		HRM MacDONALD BRIDGE RAMP MODIFICATIONS				Sketch	
		OPTION 4 ADD INSIDE LANE				SK4	

APPENDIX D

Vehicle Tracking Options

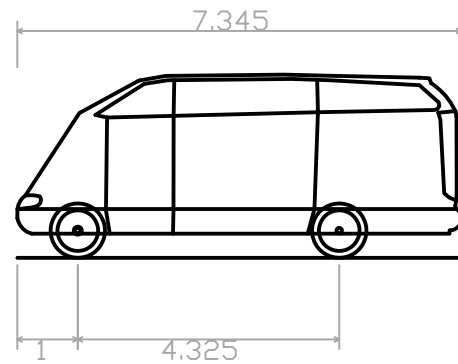

Mercedes Sprinter Panel Van 518CDI Extra Long Super High Roof

Overall Length	7.345m
Overall Width	1.993m
Overall Body Height	3.030m
Min Body Ground Clearance	0.400m
Track Width	1.993m
Lock-to-lock time	5.00s
Wall to Wall Turning Radius	7.800m

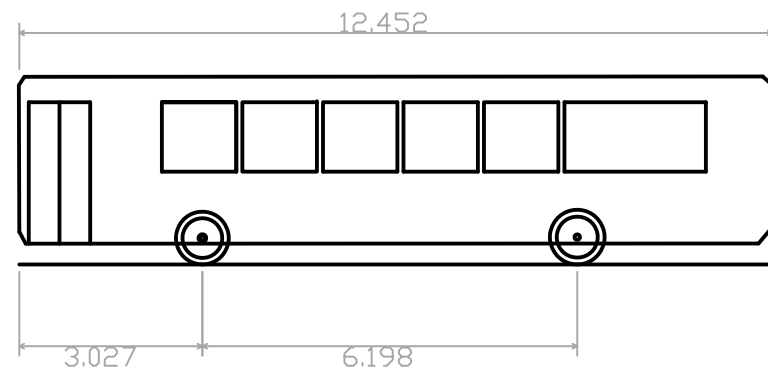

BUS - HRM 40'

Overall Length	12.452m
Overall Width	2.668m
Overall Body Height	3.110m
Min Body Ground Clearance	0.345m
Max Track Width	2.592m
Lock-to-lock time	4.00s
Wall to Wall Turning Radius	12.446m

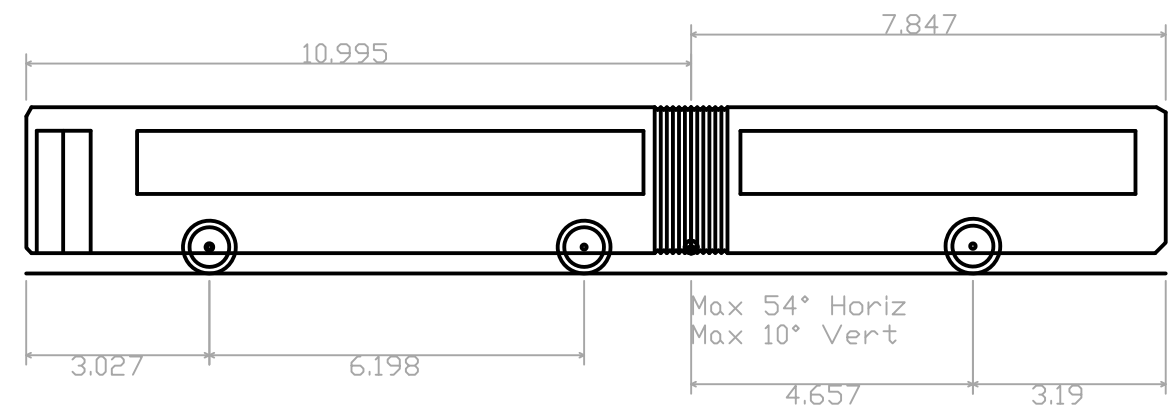

A-BUS - HRM

Overall Length	18.842m
Overall Width	2.668m
Overall Body Height	2.751m
Min Body Ground Clearance	0.338m
Max Track Width	2.592m
Lock-to-lock time	4.00s
Wall to Wall Turning Radius	13.560m

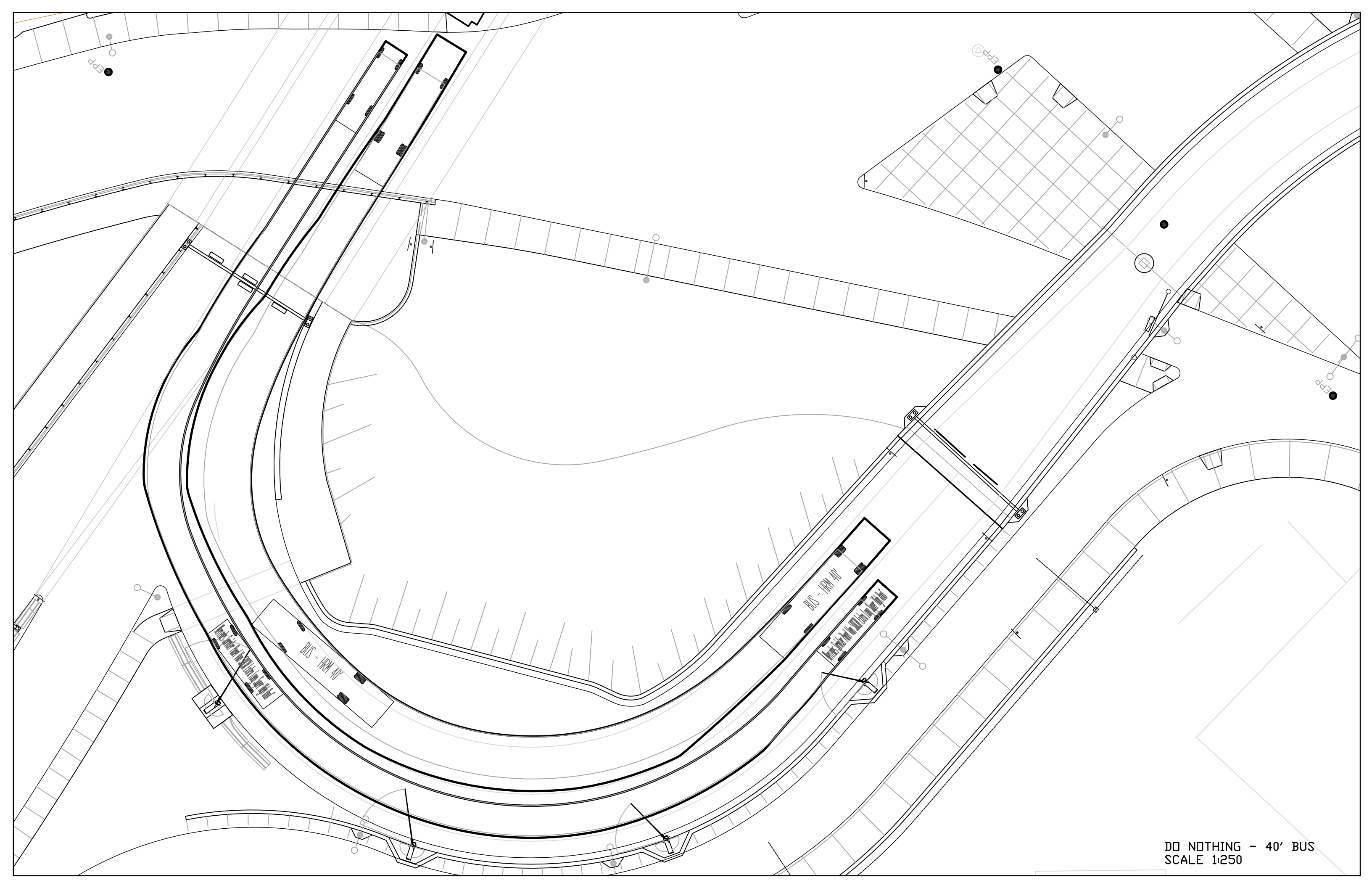

DO NOTHING - 40' BUS
SCALE 1:250

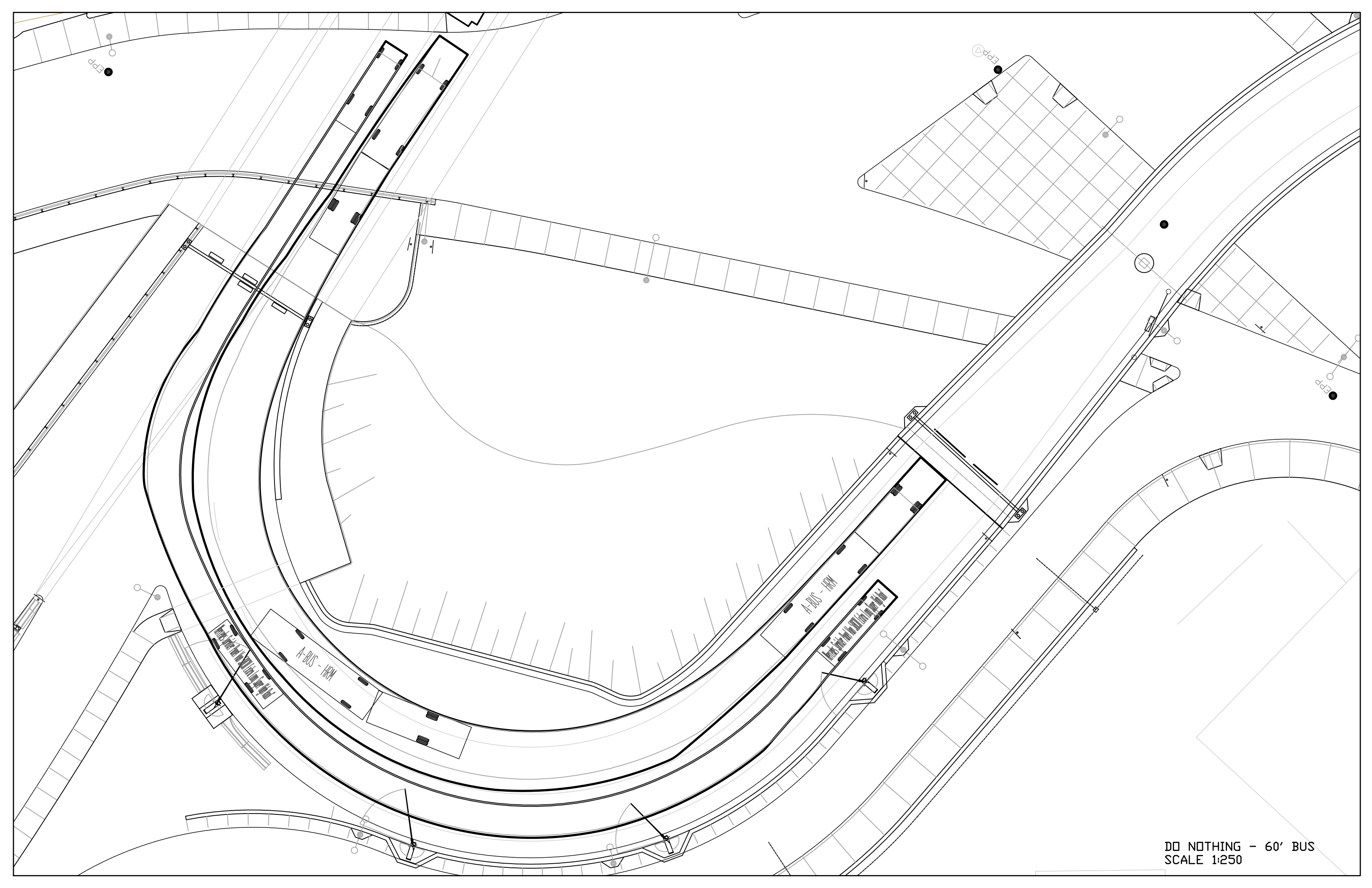

DO NOTHING - 60' BUS
SCALE 1:250

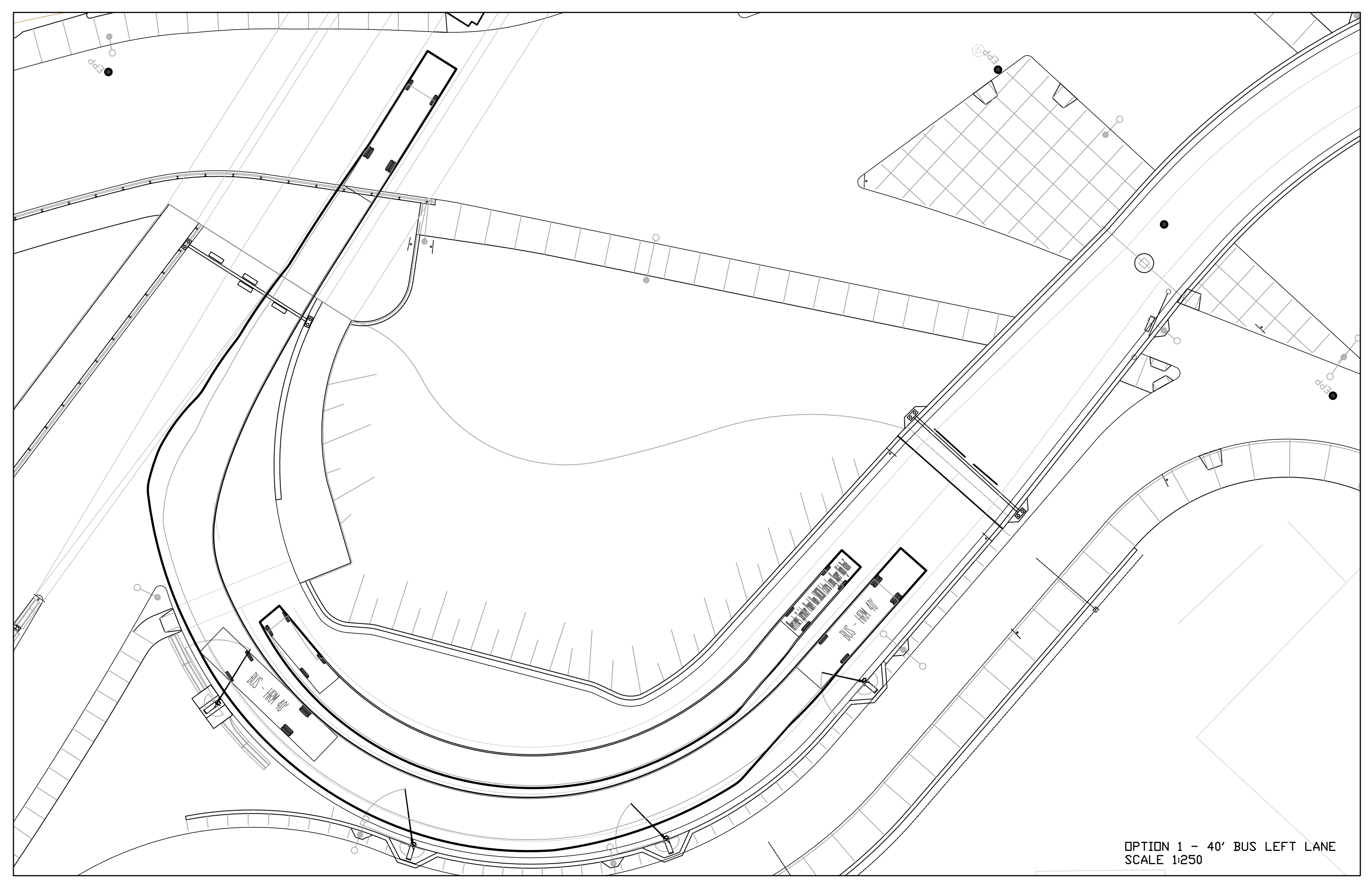

OPTION 1 - 40' BUS LEFT LANE
SCALE 1:250

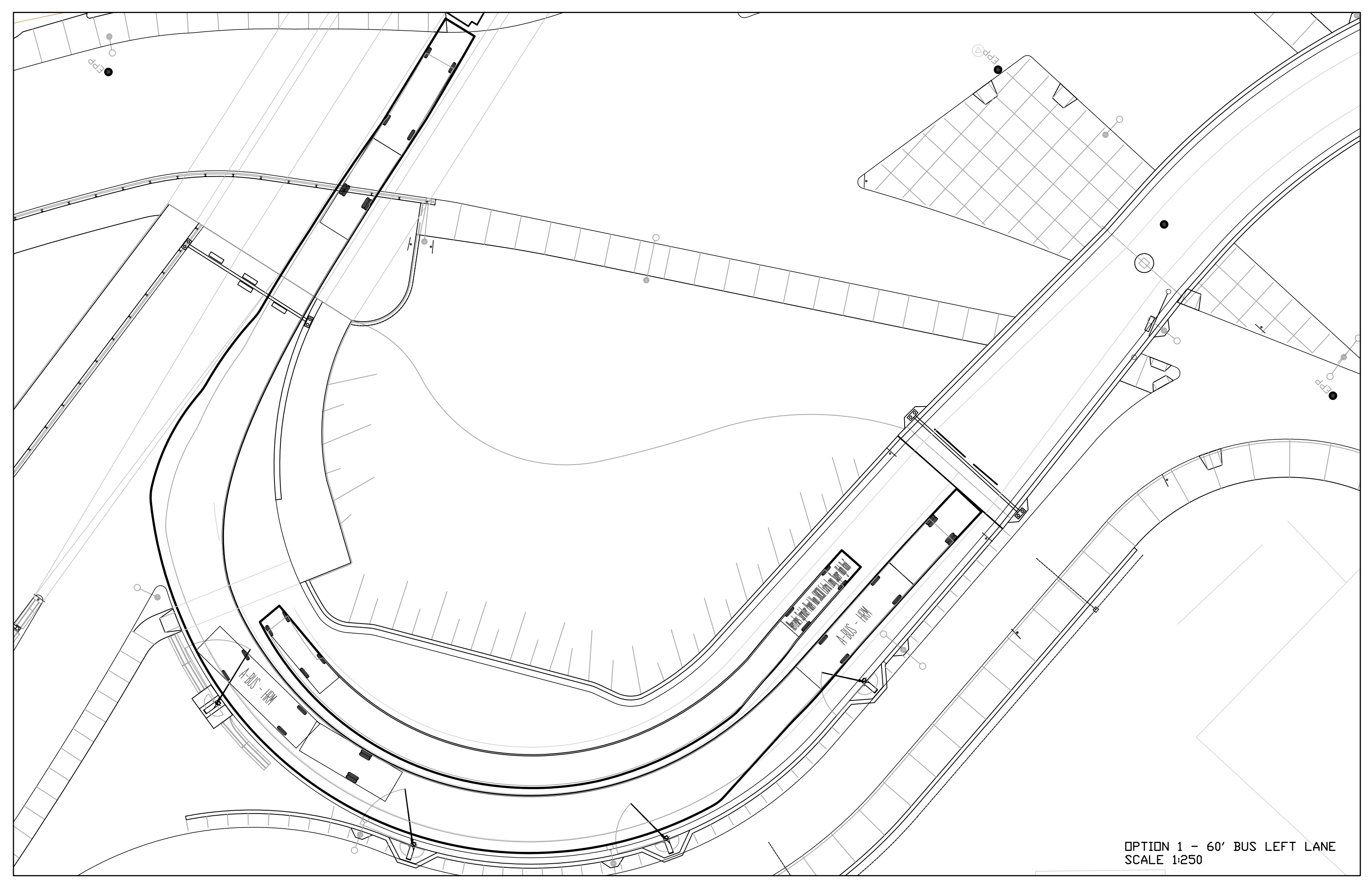

OPTION 1 - 60' BUS LEFT LANE
SCALE 1:250

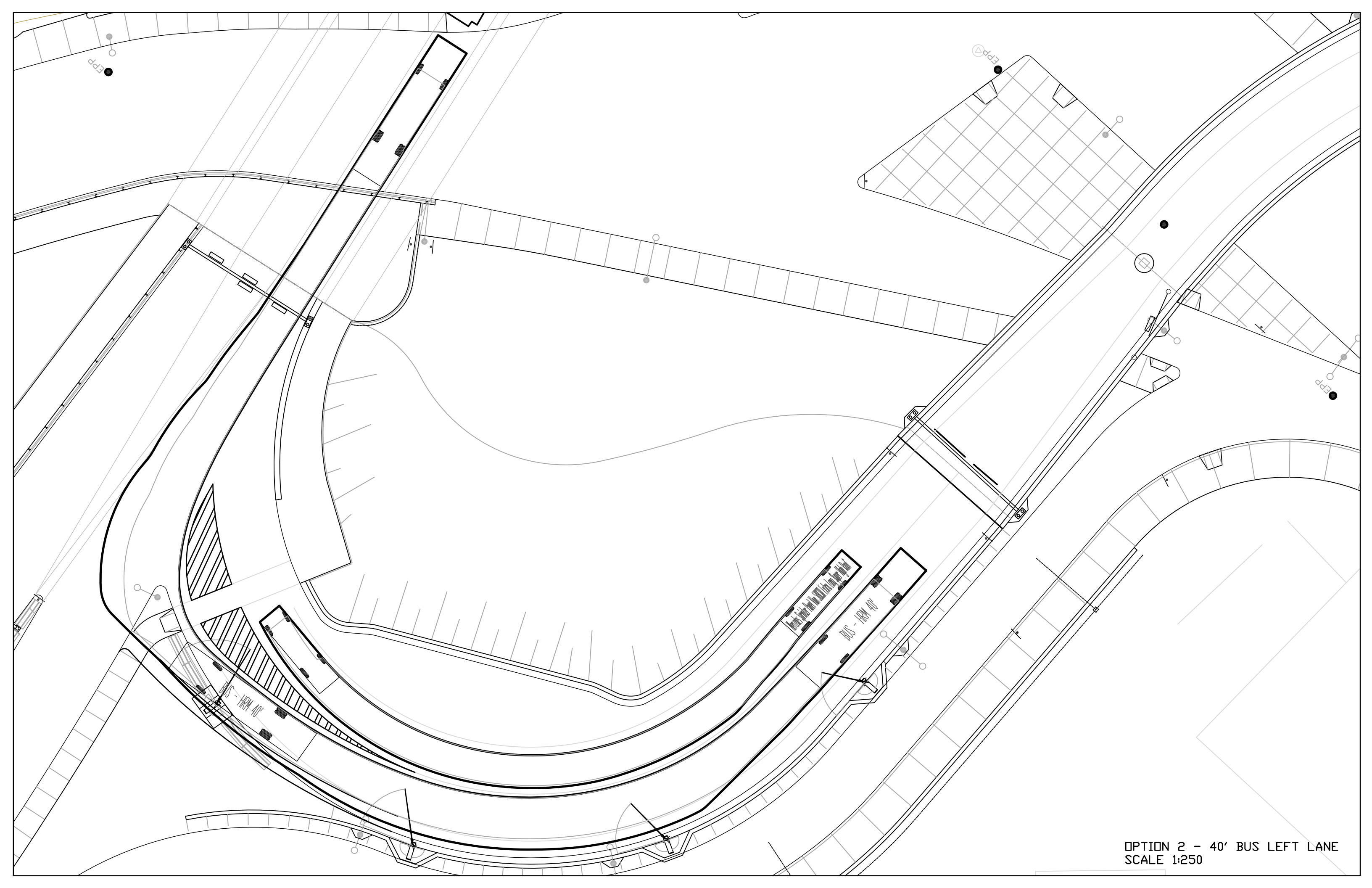

OPTION 2 - 40' BUS LEFT LANE
SCALE 1:250

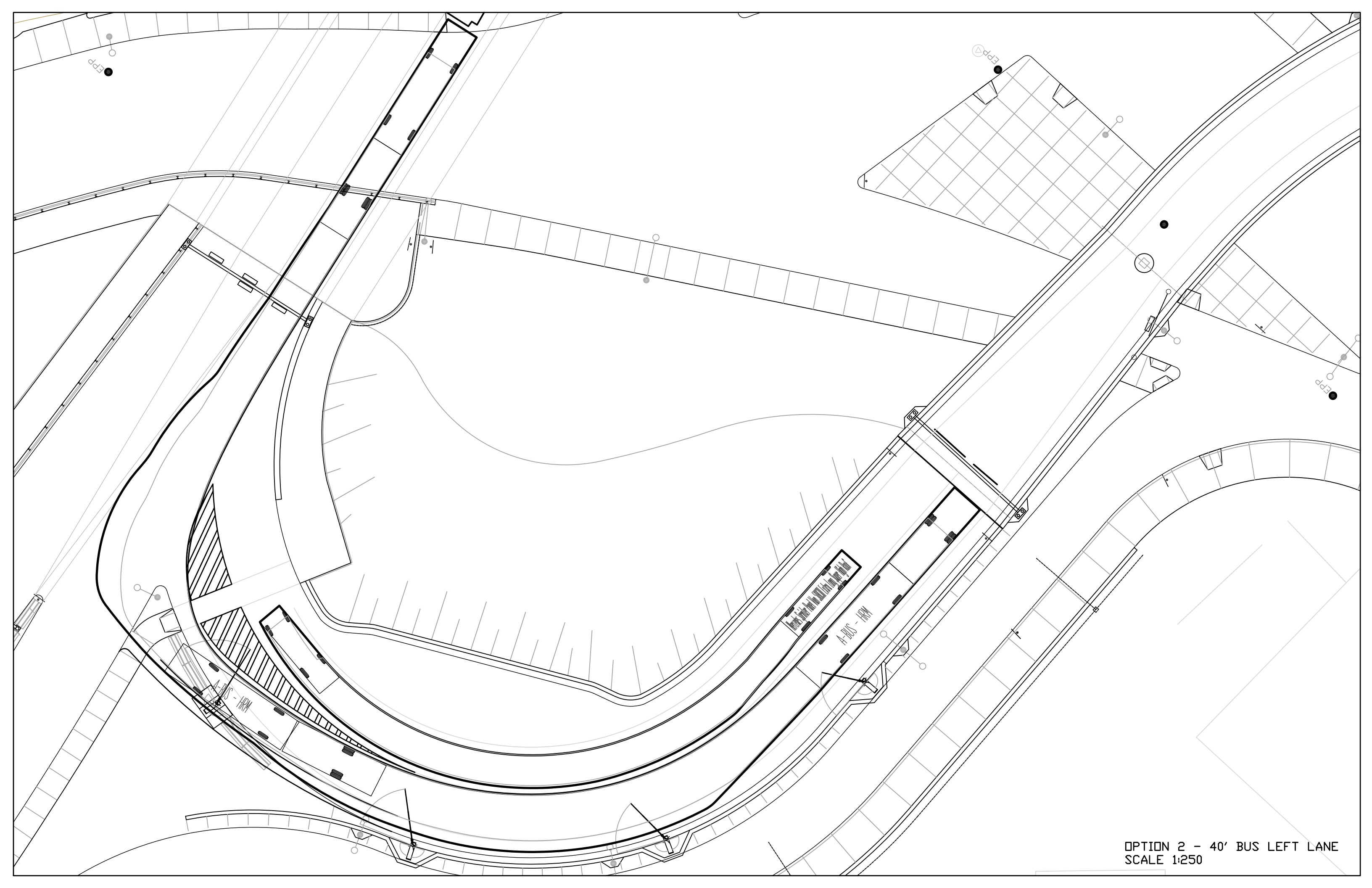

OPTION 2 - 40' BUS LEFT LANE
SCALE 1:250

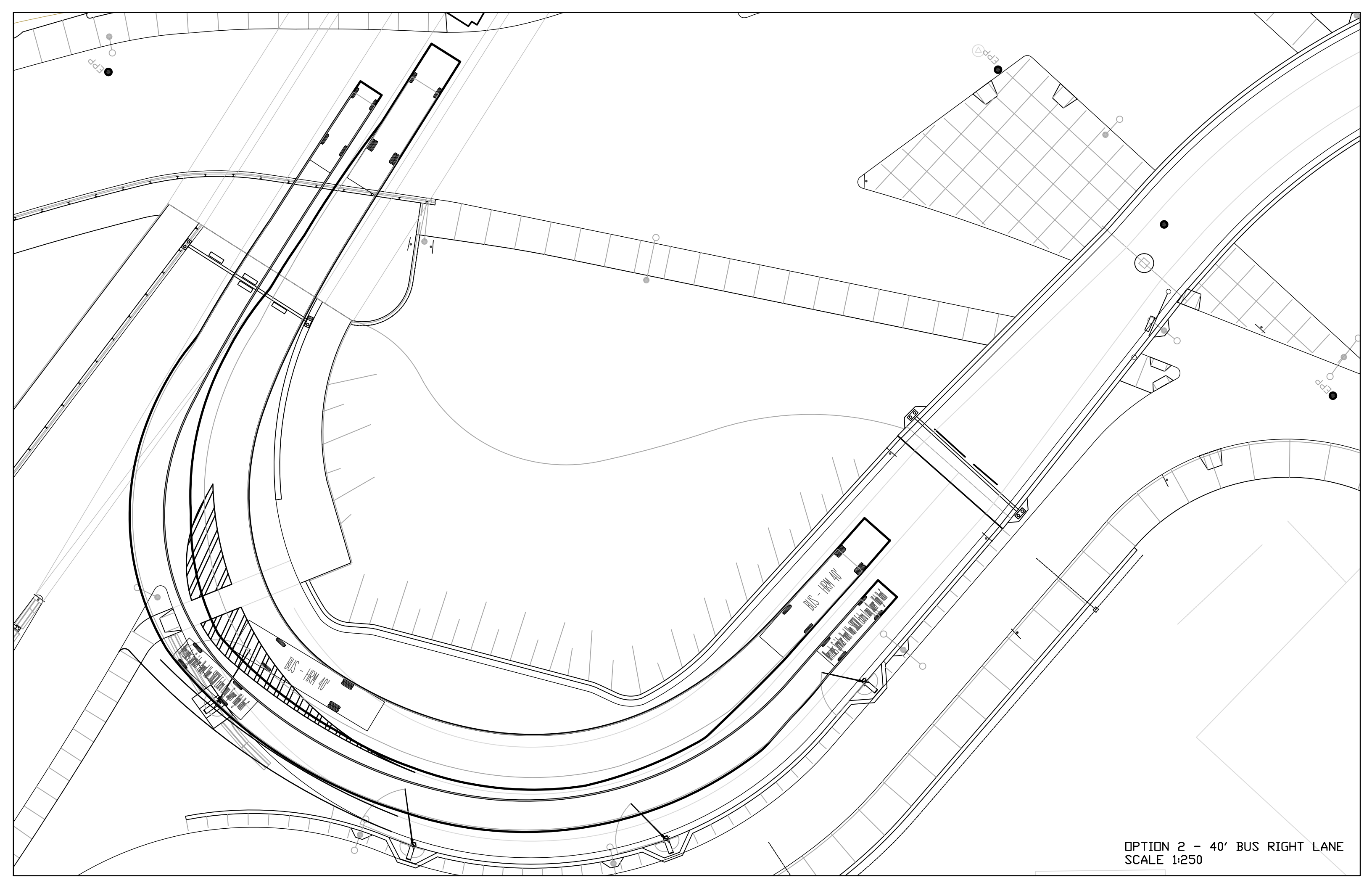

OPTION 2 - 40' BUS RIGHT LANE
SCALE 1:250

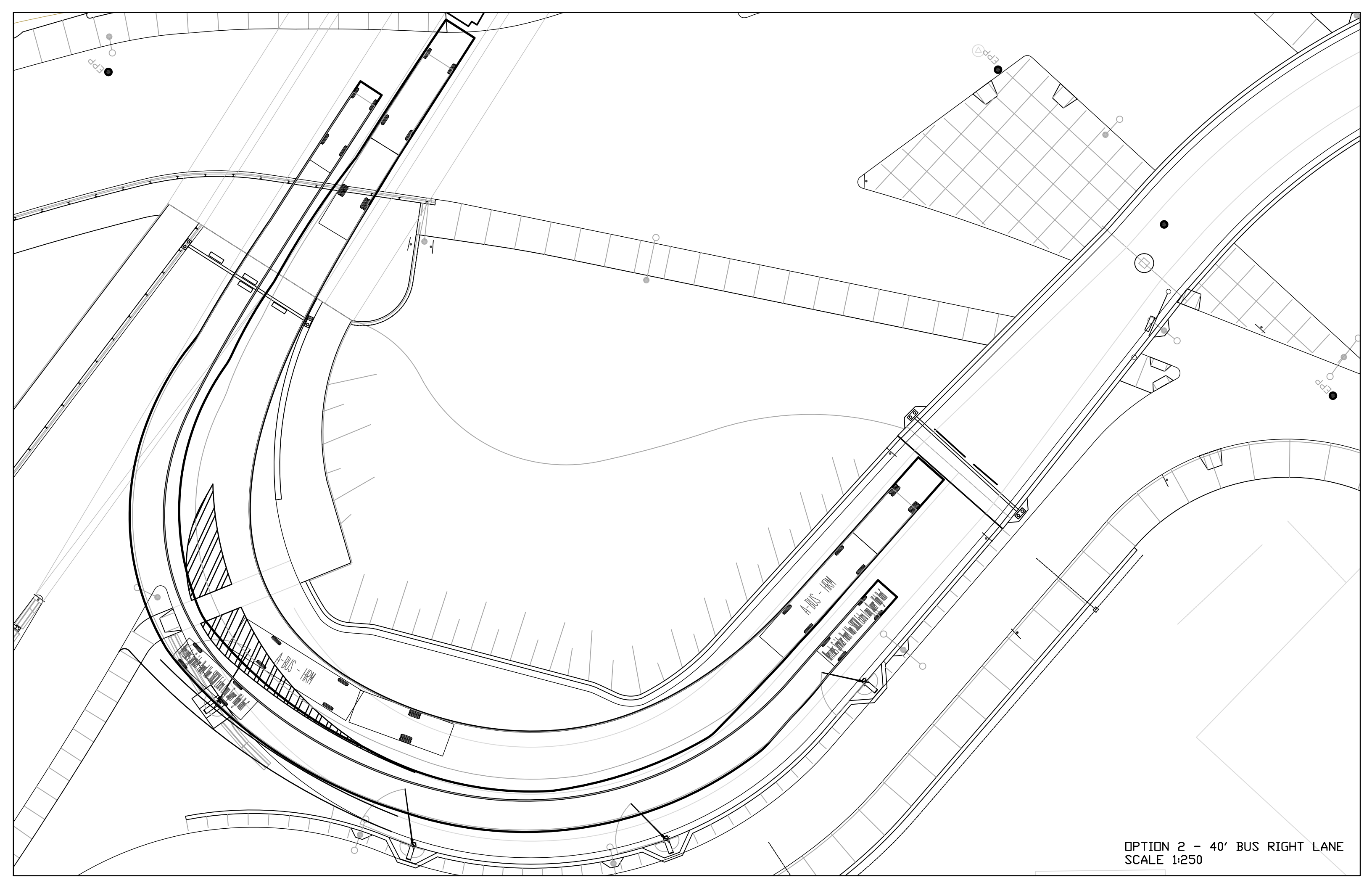

OPTION 2 - 40' BUS RIGHT LANE
SCALE 1:250

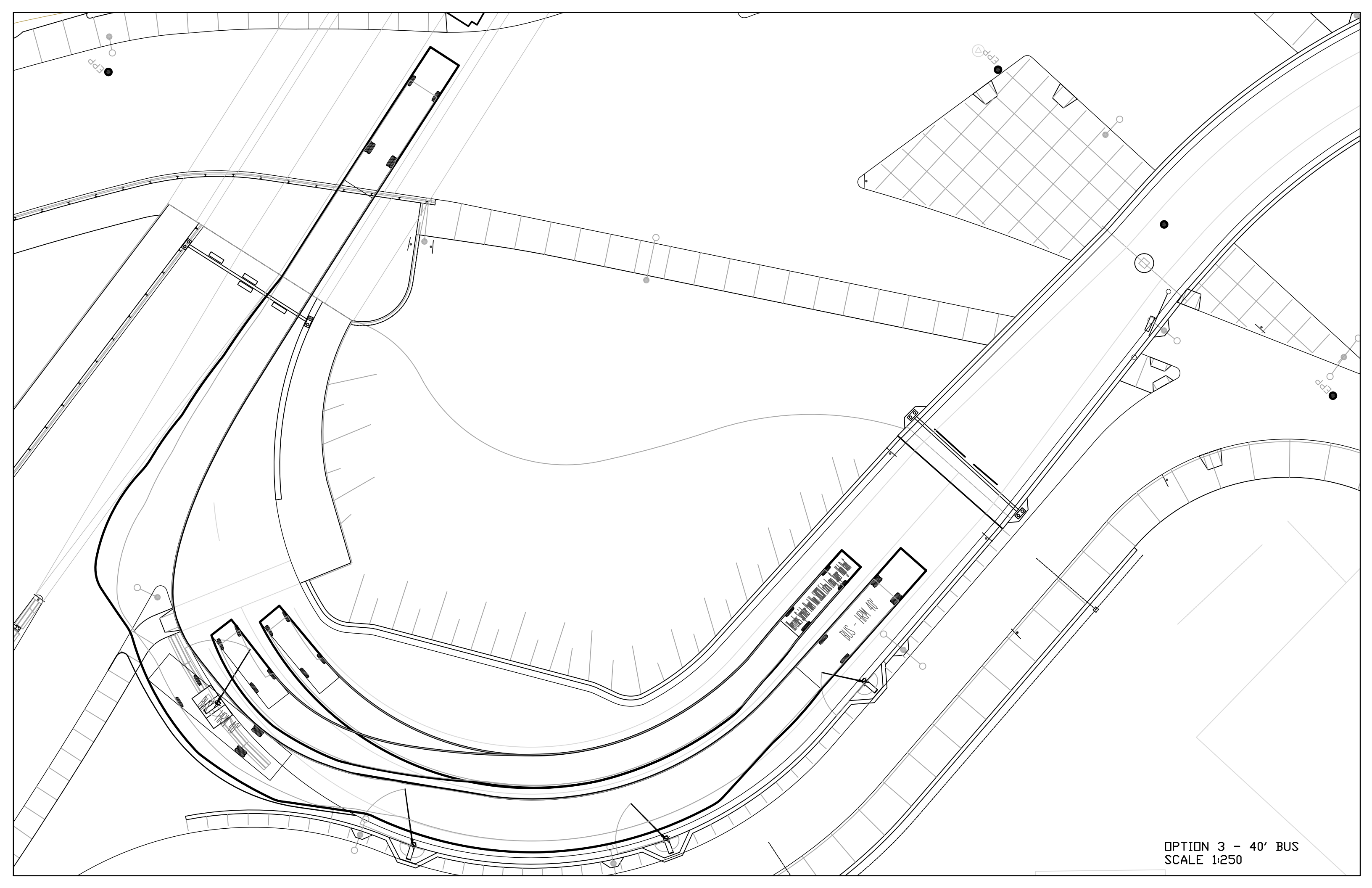

OPTION 3 - 40' BUS
SCALE 1:250

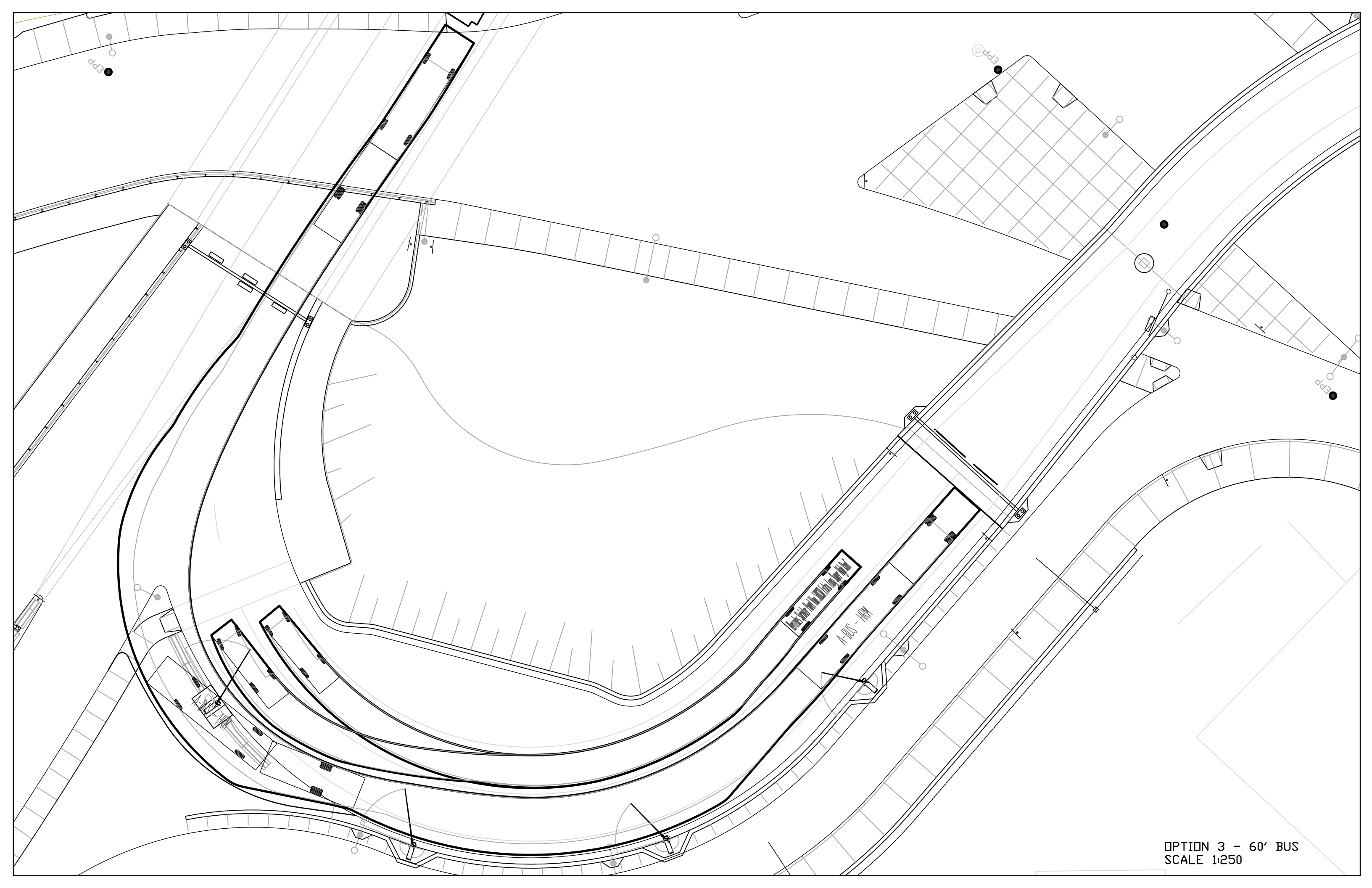

OPTION 3 - 60' BUS
SCALE 1:250

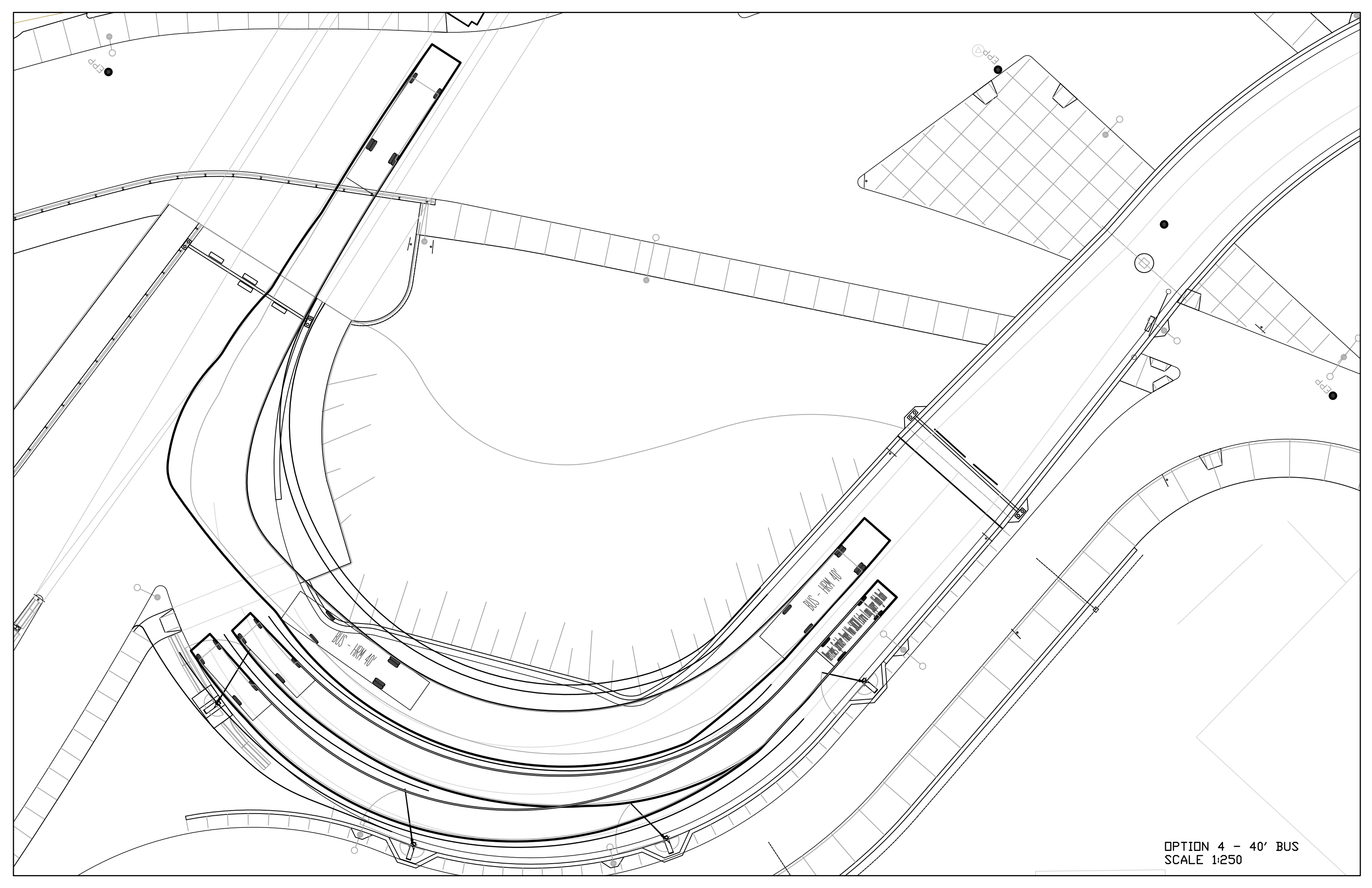

OPTION 4 - 40' BUS
SCALE 1:250

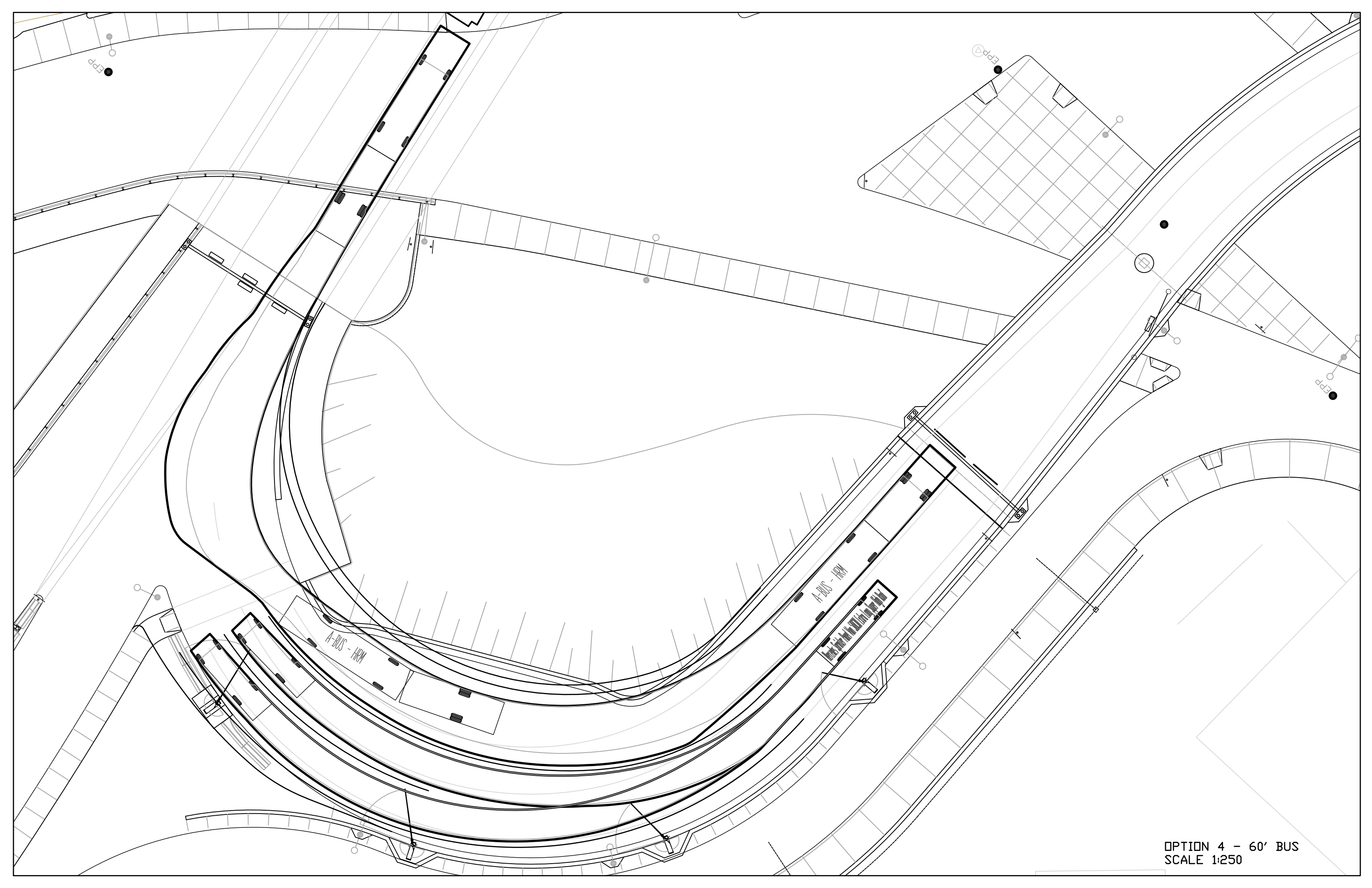

OPTION 4 - 60' BUS
SCALE 1:250

APPENDIX E

Option Constructability



DRAWING NAME: K:\PROJECTS\181063.00 HRM MACDONALD BRIDGE RAMP MODIFICATIONS\20 CAD\01 CIVIL\181063_BUSTRACKING_OPTION 1.DWG LAYOUT NAME: OPTION 1 PLOT DATE: October-24-18 3:07:08 PM CAD_OPERATOR: JPOUCET

PAINTED LINES

REMOVE GATES
(CONC. PADS TO REMAIN)

3.75
3.75m

Date OCT 24/18	Scale 1:500	Designed EN	Drawn SEM/JD	Checked MM	Approved MM	CBCL No. 181063.00	Contract
 CBCL LIMITED Consulting Engineers						HRM MacDONALD BRIDGE RAMP MODIFICATIONS OPTION 1 OUTSIDE LANE BUS-ONLY - CONSTRUCTION	
							Sketch <h1>SK5</h1>



DRAWING NAME: K:\PROJECTS\181063.00 HRM MACDONALD BRIDGE RAMP MODIFICATIONS\20 CAD\01 CIVIL\181063_BUSTRACKING_OPTION 2.DWG LAYOUT NAME: OPTION 2 PLOT DATE: October-24-18 3:07:27 PM CAD_OPERATOR: JPOUCET

PAINTED LINES

EX. INFRASTRUCTURE TO BE RELOCATED. LOCATIONS ARE APPROXIMATE & TO BE CONFIRMED IN FIELD.

PAINTED LINE

EXTEND PAINTED LINES AS SHOWN

RELOCATE TURN ARROWS

UPDATE PAINTED LINES AS SHOWN

NEW EDGE OF CURB

UPDATE PAINTED LINE TAPER

3.60m

Date OCT 24/18	Scale 1:500	Designed EN	Drawn SEM/JD	Checked MM	Approved MM	CBCL No. 181063.00	Contract
 CBCL LIMITED Consulting Engineers		HRM MacDONALD BRIDGE RAMP MODIFICATIONS				Sketch	
		OPTION 2 OUTSIDE LANE WIDENING - CONSTRUCTION				SK6	



DRAWING NAME: K:\PROJECTS\181063.00 HRM MACDONALD BRIDGE RAMP MODIFICATIONS\20 CAD\01 CIVIL\181063_BUSTRACKING_OPTION 3.DWG LAYOUT NAME: OPTION 3 PLOT DATE: October-24-18 3:07:48 PM CAD_OPERATOR: JPOUCET

PAINTED LINES

EX. INFRASTRUCTURE TO BE RELOCATED. LOCATIONS ARE APPROXIMATE & TO BE CONFIRMED IN FIELD.

EXTEND PAINTED LINES

RE-ALIGN TURN ARROW

GATES TO BE REMOVED (CONC. PADS TO REMAIN)

3.75m

TURN ARROWS

NEW CURB

GATES TO BE REMOVED (CONC. PADS TO REMAIN)

Date OCT 24/18	Scale 1:500	Designed EN	Drawn SEM/JD	Checked MM	Approved MM	CBCL No. 181063.00	Contract
 CBCL LIMITED Consulting Engineers						HRM MacDONALD BRIDGE RAMP MODIFICATIONS OPTION 3 ADD OUTSIDE LANE - CONSTRUCTION	
							Sketch <h1>SK7</h1>



DRAWING NAME: K:\PROJECTS\181063.00 HRM MACDONALD BRIDGE RAMP MODIFICATIONS\20 CAD\01 CIVIL\181063_BUSTRACKING_OPTION 4.DWG LAYOUT NAME: OPTION 4_PLOT_DATE:October-24--18 3:08:07 PM CAD_OPERATOR: JPOUCET

PAINTED LINES

EX. INFRASTRUCTURE TO BE RELOCATED. LOCATIONS ARE APPROXIMATE & TO BE CONFIRMED IN FIELD.

ADJUST CENTERLINE

EXTEND PAINTED LINES WHERE SHOWN (TYP.)

EX. TRAFFIC LIGHT TO BE RELOCATED (LOCATION APPROXIMATE)

CONSTRUCT NEW CONC. PLATFORM ON PILES, TO BE TIED BACK TO EX. PILES (THIS INCLUDES THE DEMOLITION AND RELOCATION OF EX. GUIDERAILS AND BARRIER). LOCATION OF UTILITIES MUST BE PERFORMED PRIOR TO CONSTRUCTION.

PAINTED LINES

EX. CONTROLLER CABINET c/w CONC. PAD TO BE RELOCATED (LOCATION APPROXIMATE)

REALIGN TURN ARROW
NEW EDGE OF CURB

PAINTED LINE

UPDATE PAINTED LINE TAPER

ADJUST CENTERLINE

Date OCT 24/18	Scale 1:500	Designed EN	Drawn SEM/JD	Checked MM	Approved MM	CBCL No. 181063.00	Contract
 CBCL LIMITED Consulting Engineers						HRM MacDONALD BRIDGE RAMP MODIFICATIONS	
						OPTION 4 ADD INSIDE LANE- CONSTRUCTION	
							SK8

APPENDIX F

Opinion of Probable Construction Costs



OPINION OF PROBABLE CONSTRUCTION COSTS
MacDonald Bridge Ramp Modifications
 Halifax Regional Municipality
 Class D Cost Estimates

DATE:	October 9, 2018
CBCL FILE No.:	181063.00
PREPARED BY:	JD/JJ
EST. DESCRIPTION:	Class D

No.	DESCRIPTION	UNIT	UNIT COST	OPTION 1		OPTION 2		OPTION 3		OPTION 4	
				EST. QTY.	TOTAL	EST. QTY.	TOTAL	EST. QTY.	TOTAL	EST. QTY.	TOTAL
1	Mod, Demob, Bonds, Insurance, Pre-Construction Management										
1.1	Mobilisation	LS	\$ 10,000	1	\$ 10,000	1	\$ 10,000	1	\$ 10,000	1	\$ 20,000
1.1	Environment Protection Silt Fencing	m	\$ 25	N/A	N/A	20	\$ 500	30	\$ 800	40	\$ 1,000
1.2	Traffic Control	LS	\$ 5,000	1	\$ 5,000	4	\$ 20,000	3	\$ 15,000	7	\$ 35,000
2	SOIL										
2.1	Excavation & Reuse Existing Soil	m3	\$ 75	N/A	N/A	N/A	N/A	N/A	N/A	120	\$ 9,000
3	REMOVALS / RELOCATIONS										
3.1	Utility Pole c/w Guy Wires	ea	\$ 7,000	N/A	N/A	1	\$ 7,000	1	\$ 7,000	1	\$ 7,000
3.2	Relocate Traffic Lights c/w Electrical Upgrades	ea	\$ 30,000	N/A	N/A	1	\$ 30,000	1	\$ 30,000	2	\$ 60,000
3.3	Removal of Bridge Gates	ea	\$ 5,000	4	\$ 20,000	1	\$ 5,000	1	\$ 5,000	1	\$ 5,000
3.4	Relocation of Bridge Gates	ea	\$ 30,000	N/A	N/A	1	\$ 30,000	na	N/A	1	\$ 30,000
3.5	Bench c/w Concrete Pad	ea	\$ 1,000	N/A	N/A	1	\$ 1,000	1	\$ 1,000	1	\$ 1,000
3.6	Controller Cabinet c/w Concrete Pad	ea	\$ 50,000	N/A	N/A	1	\$ 50,000	1	\$ 50,000	1	\$ 50,000
3.7	Pedestrian Ramp	ea	\$ 4,000	N/A	N/A	1	\$ 4,000	1	\$ 4,000	1	\$ 4,000
3.8	Guiderail along left lane	m	\$ 100	N/A	N/A	20	\$ 2,000	20	\$ 2,000	20	\$ 2,000
3.9	Sawcut & Remove Existing Asphalt	m2	\$ 100	N/A	N/A	N/A	N/A	N/A	N/A	30	\$ 4,000
3.10	Remove Existing Concrete Curb	m	\$ 50	N/A	N/A	N/A	N/A	N/A	N/A	70	\$ 4,000
3.11	Remove Aluminium Rail	m	\$ 40	N/A	N/A	N/A	N/A	N/A	N/A	70	\$ 3,000
3.12	Remove Rail on Sidewalk	m	\$ 70	N/A	N/A	N/A	N/A	N/A	N/A	20	\$ 2,000
3.13	Urban Traffic Sign Post	ea	\$ 1,500	N/A	N/A	N/A	N/A	N/A	N/A	4	\$ 6,000
3.14	Relocate Existing Electrical Gate Control Box	ea	\$ 20,000	N/A	N/A	N/A	N/A	N/A	N/A	1	\$ 20,000
3.15	Gate Control Box Slab Foundation	ea	\$ 3,000	N/A	N/A	N/A	N/A	N/A	N/A	1	\$ 3,000
4	CONSTRUCTION COSTS										
4.1	Pavement markings	m	\$ 20	60	\$ 2,000	20	\$ 1,000	80	\$ 2,000	20	\$ 1,000
	Concrete Sonotubes (Assume 36 in Total)										
4.2	Prepare Hole Excavation & Backfill (Assume 300mm in diameter)	m	\$ 500	N/A	N/A	N/A	N/A	na	N/A	100	\$ 50,000
4.3	35Mpa Concrete 300mm Sonotube c/w Reinforcing	m3	\$ 1,000	N/A	N/A	N/A	N/A	na	N/A	10	\$ 10,000
	Concrete Curb										
4.4	Supply and Place Concrete Curb	m	\$ 150	N/A	N/A	23	\$ 4,000	25	\$ 4,000	30	\$ 5,000
4.5	Place new Concrete Platform	m3	\$ 1,200	N/A	N/A	N/A	N/A	na	\$ -	30	\$ 36,000
	Road Resurfacing										
4.6	Supply and Place Type 2 Gravel	m3	\$ 60	N/A	N/A	22	\$ 2,000	50	\$ 3,000	100	\$ 6,000
4.7	Supply and Place Type 1 Gravel	m3	\$ 70	N/A	N/A	9	\$ 1,000	20	\$ 2,000	60	\$ 5,000
4.8	Supply and Place Asphalt Road	m2	\$ 100	N/A	N/A	43	\$ 5,000	100	\$ 10,000	180	\$ 18,000
	Regrading & Landscaping										
4.9	Import Borrow Backfill	m3	\$ 25	N/A	N/A	N/A	N/A	N/A	N/A	2,000	\$ 50,000
4.10	150mm Thick Topsoil and Sod	m2	\$ 14	N/A	N/A	N/A	N/A	N/A	N/A	1,300	\$ 19,000
5	TRAFFIC SIGNALS										
5.1	Traffic Signal Head module (Transit Phase)	LS	\$ 2,000	3	\$ 6,000	N/A	N/A	3	\$ 6,000	3	\$ 6,000
SUB-TOTAL - DIRECT & INDIRECT CONSTRUCTION COSTS					\$ 43,000		\$ 172,500		\$ 151,800		\$ 472,000
	CONTINGENCIES and ALLOWANCES										
	Design Development Contingency (see Note 1)		15%		\$ 6,450		\$ 25,875		\$ 22,770		\$ 70,800
	Construction Contingency (see Note 2)		10%		\$ 4,300		\$ 17,250		\$ 15,180		\$ 47,200
	Escalation / Inflation (Based on 2018 Dollars) (see Note 3)		N/A		N/A		N/A		N/A		N/A
	Location Factor (see Note 4)		N/A		N/A		N/A		N/A		N/A
	Engineering & Geotechnical		20%		\$ 8,600		\$ 34,500		\$ 30,360		\$ 94,400
TOTAL CONSTRUCTION COSTS with CONTINGENCIES, HST NOT INCLUDED					\$ 63,000		\$ 251,000		\$ 221,000		\$ 685,000

THIS OPINION OF PROBABLE COSTS IS PRESENTED ON THE BASIS OF EXPERIENCE, QUALIFICATIONS, AND BEST JUDGEMENT. IT HAS BEEN PREPARED IN ACCORDANCE WITH ACCEPTABLE PRINCIPLES AND PRACTICES. MARKET TRENDS, NON-COMPETITIVE BIDDING SITUATIONS, UNFORESEEN LABOUR AND MATERIAL ADJUSTMENTS AND THE LIKE ARE BEYOND THE CONTROL OF CBCL LIMITED. AS SUCH WE CANNOT WARRANT OR GUARANTEE THAT ACTUAL COSTS WILL NOT VARY FROM THE OPINION PROVIDED.

- Note 1** A Design Development Contingency is intended to allow for the necessary growth of quantities, increase material & construction costs as the work is better defined in the future.
- Note 2** A Construction Contingency is intended to allow for the cost of additional work that is over and above the original tendered construction contract price.
- Note 3** The Escalation/Inflation allowance is provided to account for anticipated increases in construction costs from the time budget is prepared until the time of Tender submissions.
- Note 4** The Location Factor is provided to account for anticipated variances between construction costs at the location of the project and historical construction costs data used to prepare the budget.
- Note 5** Note that for the above UNIT RATE FORMAT General Contractor, Fees, Overheads and Profit are included in each unit cost.



P.O. Box 1749
Halifax, Nova Scotia
B3J 3A5 Canada

Item No. 14.5.1
Halifax Regional Council
August 14, 2018

TO: Mayor Savage and Members of Halifax Regional Council

Original Signed

SUBMITTED BY: _____
Councillor Tim Outhit, Chair, Transportation Standing Committee

DATE: July 31, 2018

SUBJECT: Transit Priority Corridor: Gottingen Street

ORIGIN

July 26, 2018 meeting of the Transportation Standing Committee, Item No. 12.1.1.

LEGISLATIVE AUTHORITY

Administrative Order 1, Respecting the Procedures of the Council, Schedule 7, Transportation Standing Committee Terms of Reference, section 4 (d):

Duties and Responsibilities

4. The Transportation Standing Committee shall oversee and review of the Municipality’s Regional Transportation Plans and initiatives, as follows: providing input and review of the Transportation Road network strategies and related Regional initiatives.

RECOMMENDATION

The Transportation Standing Committee recommend that Halifax Regional Council:

1. Approve the detailed design as shown in Attachment B of the staff report dated June 21, 2018.
2. Approve the parking loss mitigation plan as described in Attachment C of the staff report dated June 21, 2018.
3. Direct staff to proceed with implementation of a peak period (7am-9am and 3pm-6pm, Monday to Friday) northbound bus lane on the Gottingen Street corridor.
4. Approve the evaluation methodology as per Attachment E of the staff report dated June 21, 2018 through which the Gottingen Street peak period northbound bus lane will be measured and evaluated one year after implementation.

BACKGROUND

A staff report dated June 21, 2018 pertaining to a proposed Transit Priority Corridor for Gottingen Street was before the Transportation Standing Committee for consideration at its meeting held on July 26, 2018.

For further information, please refer to the attached staff report dated June 21, 2018.

DISCUSSION

Staff provided a presentation and responded to questions from the Standing Committee respecting the parking loss mitigation, the peak period northbound bus lane, and the detailed design of the of the proposed transit corridor. In addition to the recommendation outlined in this report, the Transportation Standing Committee approved an additional motion requesting that a supplementary staff report be provided to Regional Council for its August 14, 2018 meeting outlining the detailed design of the complete streets element and public realm for the Gottingen Street Transit Priority Corridor.

FINANCIAL IMPLICATIONS

As outlined in the attached staff report dated June 21, 2018.

RISK CONSIDERATION

As outlined in the attached in the staff report dated June 21, 2018.

COMMUNITY ENGAGEMENT

The Transportation Standing Committee meetings are open to public attendance, a live webcast is provided of the meeting, and members of the public are invited to address the Committee for up to five minutes at the end of each meeting during the Public Participation portion of the meeting. The agenda, reports, video, and minutes of the Transportation Standing Committee are posted on Halifax.ca

ENVIRONMENTAL IMPLICATIONS

As outlined in the attached staff report dated June 21, 2018.

ALTERNATIVES

The Transportation Standing Committee did not discuss alternative recommendations.

ATTACHMENTS

1. Staff report dated June 21, 2018.
2. Staff presentation dated July 26, 2018.

A copy of this report can be obtained online at halifax.ca or by contacting the Office of the Municipal Clerk at 902.490.4210.

Report Prepared by: Liam MacSween, Legislative Assistant, 902.490.6521.



P.O. Box 1749
Halifax, Nova Scotia
B3J 3A5 Canada

Attachment 1
Transportation Standing Committee
July 26, 2018

TO: Chair and Members of Transportation Standing Committee

Original Signed

SUBMITTED BY:

Kelly Denty, Director, Planning & Development

Original Signed

Dave Reage, MCIP, LPP, Director, Halifax Transit

Original Signed

Jacques Dubé, Chief Administrative Officer

DATE: June 21, 2018

SUBJECT: Transit Priority Corridor: Gottingen Street

ORIGIN

At the March 6, 2018 meeting of Regional Council, the following motion was put and passed:

That Halifax Regional Council proceed with detailed design of a continuous northbound bus lane on the Gottingen Street corridor at peak (7am-9am and 3pm-6pm, Monday to Friday), with a provision for intermittent northbound transit priority measures off peak, that will include allowing short duration time regulated (15-90 minute) parking and loading where appropriate, and to return to the Transportation Standing Committee with:

1. A Parking Loss Mitigation Plan which includes engagement with the public and stakeholders, returning with a recommendation prior to tendering the project;
2. A supplementary report regarding the potential for moving northbound express buses (as planned) to a different route and moving Dartmouth bound express buses to Barrington Street via the Bridge ramp;
3. A plan to measure and evaluate the impact of the project and recommend changes, if any, within one year of implementation.

LEGISLATIVE AUTHORITY

Transportation Standing Committee Terms of Reference, section 4 (a) which states: "The Transportation Standing Committee shall oversee and review the Municipality's Regional Transportation Plans and initiatives, as follows: overseeing HRM's Regional Transportation Objectives and Transportation outcome Areas".

Halifax Regional Municipality Charter, subsection 318(2): “In so far as is consistent with their use by the public, the Council has full control over the streets in the Municipality.”

Halifax Regional Municipality Charter, subsection 322(1): “The Council may design, lay out, open, expand, construct, maintain, improve, alter, repair, light, water, clean, and clear streets in the Municipality.”

RECOMMENDATION

It is recommended that the Transportation Standing Committee recommend that Halifax Regional Council:

1. Approve detailed design as shown in Attachment B of this report.
2. Approve the parking loss mitigation plan as described in Attachment C of this report.
3. Direct staff to proceed with implementation of a peak period (7am-9am and 3pm-6pm, Monday to Friday) northbound bus lane on the Gottingen Street corridor.
4. Approve the evaluation methodology as per Attachment E of this report through which the Gottingen Street peak period northbound bus lane will be measured and evaluated one year after implementation.

BACKGROUND

The Halifax Transit *Moving Forward Together Plan* (MFTP), approved by Regional Council in April 2016, identifies Gottingen Street as a critical choke point for transit service that requires transit priority. To improve transit service on the corridors, the MFTP recommends investment in transit priority measures (TPMs) that provide priority to the movement of buses over general traffic. These recommendations have been further reinforced by policy direction in the recent Council adopted *Integrated Mobility Plan* (IMP) (December 2017).

Following approval of the MFTP and securement of funding support from the Public Transit Infrastructure Fund (PTIF), a consultant was retained in May 2017 to complete a functional design study for the Gottingen Street transit priority corridor, as well as the Bayers Road corridor. The functional design study, which was completed in January 2018, considered multiple design options for the Gottingen Street corridor, representing a range of costs. Based on the findings of the functional design study and significant input from public and stakeholders, staff recommended that the preferred concept – a dedicated, continuous northbound bus lane on Gottingen Street (Cogswell Street to North Street) – be advanced to detailed design and implementation.

At the March 6, 2018 meeting of Regional Council, Regional Council directed staff to proceed with detailed design of a time-restricted northbound bus lane on Gottingen Street that is operational during weekday peak periods (7am-9am and 3pm-6pm), and that accommodates time-regulated parking and loading outside of peak periods. Regional Council also directed staff to return to the Transportation Standing Committee with a Parking Loss Mitigation Plan (based on engagement with the public and stakeholders), a supplementary report regarding the potential for moving northbound express buses to a different route and moving Dartmouth bound express buses to Barrington Street via the Bridge ramp, and a plan to measure and evaluate the impact of the project and recommend changes (if any) within one year of implementation.

In April 2018, WSP Canada Inc. was retained to complete detailed design for transit priority upgrades on Gottingen Street as described above. The detailed design process – completed collaboratively by staff and the consultant team – included engagement with stakeholders and the public, along with the development of a Parking Loss Mitigation Plan and a plan to monitor and evaluate operation of the corridor over a one-year period.

DISCUSSION

Proposed Street Configuration

The proposed configuration for the Gottingen Street transit priority corridor as directed by Regional Council on March 6, 2018 (illustrated in Figure 1) includes a time-restricted northbound transit lane on the east side of Gottingen Street that provides dedicated space for northbound buses during weekday peak traffic periods (7AM-9AM, 3PM-6PM). Right-turning traffic is also permitted to use the northbound bus lane at intersections, similar to other transit priority measures currently in use in Halifax (i.e. Windmill Road, Dartmouth). During off-peak periods, the lane accommodates time-regulated parking and loading. Parking, loading, and stopping on the west side of the street (southbound direction), which are currently accommodated intermittently, will no longer be permitted. Although the previous motion called for provision of intermittent transit priority measures (included in the functional design drawings as signalized pedestrian crossings or 'half signals' and a transit queue jump signal at Cornwallis Street), these transit priority measures have not been incorporated into the detailed design, as they are not expected to provide significant benefits. The need for these measures will be monitored and may be considered in the future if deemed to be necessary from the transit priority and/or pedestrian safety perspective.

This configuration was the preferred option based on a review of multiple alternatives during the functional design process. Dedicated space is provided for buses where and when it is most needed, and during less congested periods, street space is available to facilitate vehicular access to Gottingen Street properties.

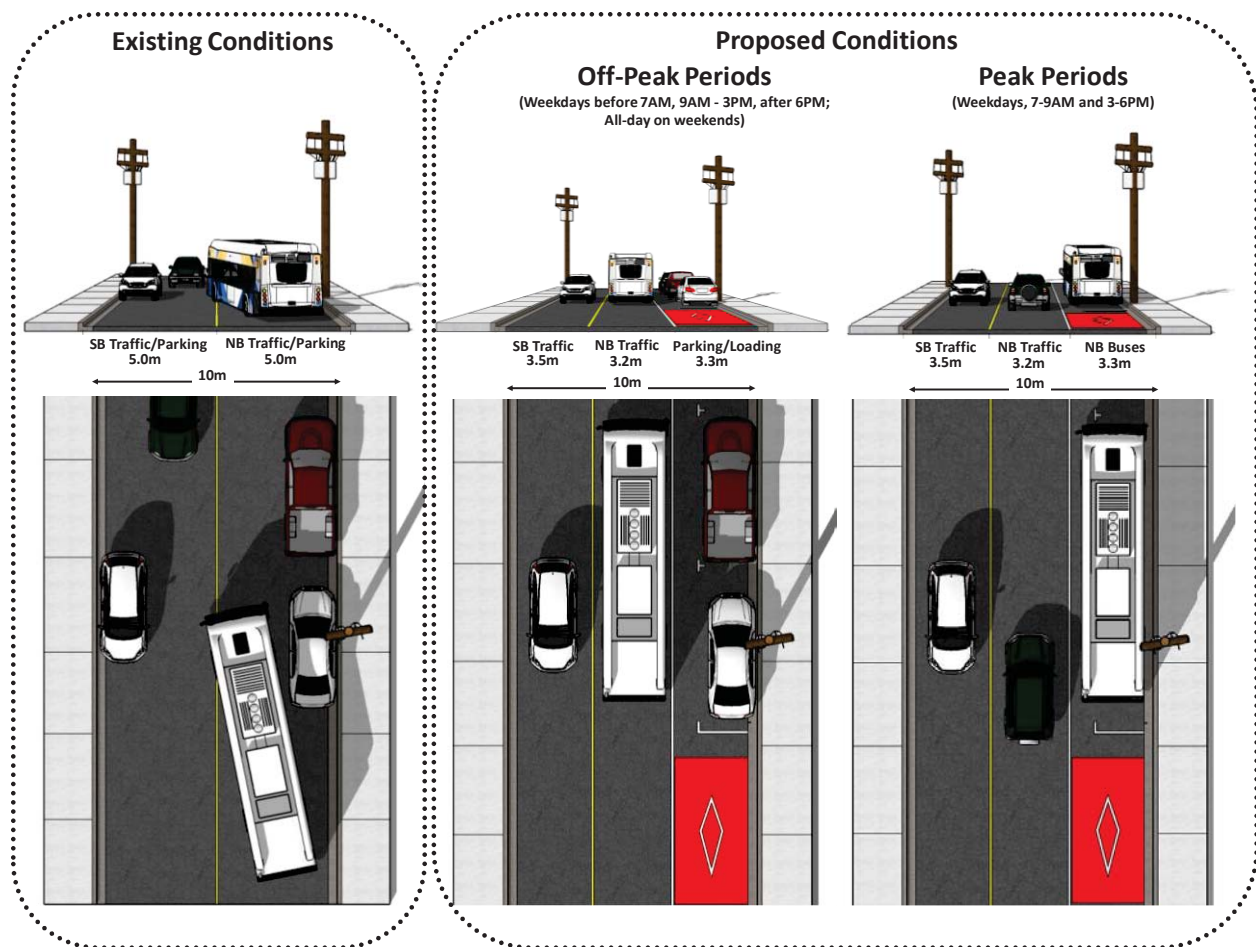

Figure 1: Existing and proposed typical cross section (looking to the north) - Gottingen Street

Design Considerations

Detailed design drawings for the corridor are provided in **Attachment A**. Key design considerations are summarized below.

- *Cross Section Elements*: Gottingen Street ranges in width (curb-to-curb) from a minimum of 9.6m to a maximum of 13.1m, though most of the corridor is 10.0m-10.2m wide. The proposed cross section, illustrated in Figure 1, includes a minimum typical width of 3.4m for the northbound transit lane and the southbound curb lane. The northbound traffic lane (center lane) has a minimum width of 3.2m. The proposed lane widths are consistent with design guidance from the National Association of City Transportation Officials (NACTO) *Transit Street Design Guide*, which recommends a minimum width of 3.3m-3.6m for curbside transit lanes and 3.05m for general traffic lanes.
- *Pavement Markings / Signage*: The northbound curb lane will be delineated by a solid white line, and will include diamond pavement markings, bounded by red paint, to identify its reserved status for buses during the peak periods. A combination of side-mounted and overhead signs will establish the regulatory status of the bus lane, and will detail the time periods within which transit priority is in effect.
- *Pedestrian Enhancements*: The design includes the addition of curb extensions to reduce the crossing distance for pedestrians at the Cunard Street, Portland Place, and Uniacke Street intersections. These curb extensions will be located on the side streets and not on Gottingen Street. Additional street trees are also being proposed to improve the streetscape and improve the buffer between pedestrians and the street. An application has been made to fund the implementation of additional pedestrian enhancements through the Department of Energy's Connect2 program. If the application is successful, it will be implemented with this project; if unsuccessful, funds will be requested in the 2019-20 budget process. Signalized pedestrian crossings or 'half signals', which were considered in the functional design as a means to enhance pedestrian crossings and provide intermittent transit priority measures, are not being considered at this time. The need for these pedestrian crossing treatments will be monitored and may be considered in the future if deemed to be necessary from the transit priority and/or pedestrian safety perspective.

Overview of Impacts:

Various impacts of the proposed transit priority upgrades are summarized in the following sections.

Transit Service:

There are currently 18 Halifax Transit routes that travel on Gottingen Street, which could generate up to 79 buses per hour (2-way) during the busiest peak hour. Scheduled transit volumes indicate that the busiest peak volume of buses is closer to 68 buses for the busiest hour.

Planned service level changes in the approved MFTP could increase the number of buses using Gottingen Street to a potential total of 90 bidirectional trips during the peak hour. This figure represents a theoretical value based on assumed levels of transit service as described in the MFTP, and could vary based on scheduled timings. This increase was determined as part of the public engagement process during the MFTP, and reflects changes in the level of service for local, limited stop, and express service on the Gottingen Street Corridor. Transit service on Gottingen Street is hindered by traffic congestion during peak periods, as well as by the need for buses to manoeuvre around vehicles stopped or parked in the curb lanes throughout the day.

The proposed bus lane will provide significant transit improvement during peak periods, most notably in the northbound direction. Buses in both directions will avoid obstruction by parked cars, and northbound buses will have the ability to bypass traffic congestion, reducing delay and improving reliability. As Gottingen Street is served by a number of routes with origins and destinations throughout the city, the proposed bus lane will result in benefit to individuals travelling along the Gottingen Street Corridor as well as passengers network wide.

On-Street Parking and Loading:

The peak period northbound bus lane requires the following curb access restrictions on Gottingen Street:

- *No stopping in the northbound curb lane during peak periods (weekdays 7-9AM and 3-6PM).* The bus lane must remain clear of obstruction while operational.
- *Parking and loading permitted in the northbound curb lane during off-peak periods (weekdays before 7AM, 9AM-3PM, after 6PM and weekends).* When the bus lane is not operational, parking/loading will be permitted in the northbound curb lane.
- *No stopping in the southbound curb lane at any time:* Due to the width of the proposed southbound lane, there will not be sufficient width to allow vehicles to manoeuvre around stopped vehicles without entering the opposing traffic lane.

The loss of the ability for traffic to stop to access the curb (northbound during peak periods, southbound full-time) has implications for curbside activities including short-term loading (including moving, parcel delivery), solid waste collection, and passenger drop-off / pick-up. It will be necessary for Gottingen Street businesses and residents, as well as municipal services, to make changes to the way these curbside activities are completed – options include shifting these activities outside of peak periods, or completing them via a side street or the opposite side of the street.

Enforcement of curbside access restrictions will be key to the success of the proposed transit lane. During peak periods, ticketing and/or towing of vehicles in the bus lane will be necessary to keep it free of obstructions. Parking enforcement will be expanded to this area, however, due to limitations with existing resourcing, staff may be drawn from other areas to provide the necessary coverage. Presently, limited parking enforcement (a result of resource shortages) has resulted in extended parking (in some cases, all-day) in time-restricted parking areas. The increased enforcement that is essential for the transit lane will promote higher turnover parking, an improvement to parking availability that should benefit businesses in the area. Recognizing that increased parking enforcement will be necessary for this and other transit priority lanes, staff are also exploring other enforcement capacity including providing Transit Supervisors with the ability to enforce parking within the transit lane and possibly Halifax Police support through available community response officers.

Parking Loss Mitigation Plan:

Recognizing the importance of on-street parking and loading for businesses and residents of Gottingen Street, the detailed design process included the completion of a parking loss mitigation plan. The objective of the parking loss mitigation plan was to quantify the anticipated change in on-street parking and loading resulting from the proposed street changes, and identify opportunities to add on-street parking and loading to reduce the net loss. Strategies that were used to reduce parking and loading impacts included:

- Reallocating and optimizing curb space on Gottingen Street to more efficiently lay out parking and loading areas
 - Where possible, allowing parking in areas where it was previously prohibited;
 - Minor changes to bus stop locations
- Modifying parking restrictions on side streets and adjacent streets
 - Converting existing on-street parking space to dedicated strategically located loading space

As part of the parking loss mitigation plan, staff consulted local businesses and property owners to better understand their parking and loading needs. A total of 29 questionnaires focusing on parking and loading were completed through in-person meetings and email / mail-in returns. Staff met one-on-one with representatives from 12 businesses during multiple site visits. A local stakeholder meeting was also held on Monday, May 14, 2018, which was attended by 18 business owners.

Table 1 displays the existing and proposed number of off-peak parking spaces on the east and west sides of Gottingen Street. Overall, the project will result in a net loss of 8 parking spaces on Gottingen Street. Although the potential to add parking spaces on side streets was considered, the design does not propose any changes to side street controls given the relatively low existing parking utilization on Gottingen Street and the resulting need to remove existing ‘no parking’ areas that facilitate loading activities. On-street parking utilization will be monitored during the project evaluation period, and changes will be considered as required. Further detail regarding the parking loss mitigation plan is provided in **Attachment C**.

Table 1: Gottingen Street – Existing and Proposed On-street Parking

		# of On-Street Off-peak Parking Spaces		
		Existing	Proposed	Net Change
North Street to Uniacke Street	East Side	0	6	+6
	West Side	0	0	-
Uniacke Street to Prince William Street	East Side	6	15	+9
	West Side	15	0	-15
Prince William Street to Cornwallis Street	East Side	7	9	+2
	West Side	12	0	-12
Cornwallis Street to Portland Place	East Side	7	10	+3
	West Side	1	0	-1
Portland Place to Cogswell Street	East Side	4	4	-
	West Side	0	0	-
Total		52	44	-8

Other Street Users:

The proposed changes to Gottingen Street will impact other users of the street in the following manner:

- **Pedestrians:** During peak periods, when the bus lane is operational, pedestrians crossing Gottingen Street will cross three lanes (an increase of one lane from existing conditions and off-peak conditions, which requires pedestrians to cross two lanes). The revised lane configuration will require that buses consistently travel closer to the curb, which may have an adverse impact on pedestrian comfort. The existing sidewalks, which are typically 2.5-3.5m in width (curb to edge of right-of-way), are buffered in most areas by planters, trees, and other infrastructure on the east side of the street, which helps mitigate these concerns. Additional tree installations are being proposed as part of this project to improve buffering in areas where opportunities are available. Also, crossing distances for side streets including Portland Place, Cunard Street, and Uniacke Street will be shortened through the addition of curb extensions.
- **Cyclists:** Bicycles will continue to travel in both directions on Gottingen Street at all times. During peak periods, northbound cyclists will ride within the transit lane, and buses will be required to yield to cyclists. During off-peak periods, cyclists will ride between the northbound traffic lane and parked vehicles on the east side of the street. At all times, southbound cyclists will be required to ride as far the right as practicable on the west side of the street. Though these conditions are not ideal for cyclists, they represent an improvement over the existing configuration, which – in addition to sharing space with buses and vehicles – forces cyclists to navigate around vehicles parked on both sides of the street. It is also noted that although Gottingen Street is well used by cyclists, Maynard

Street and Creighton Street are nearby parallel streets that are identified as north-south cycling routes in the *Active Transportation Priorities Plan*.

- *Vehicular Traffic*: The proposed street configuration will narrow existing traffic lanes, and the ability of through vehicles to bypass vehicles waiting to turn left at intersections. As a result, peak period (7-9AM, 3-6PM) left turn restrictions are being proposed at the Cornwallis Street intersection to avoid delays and vehicle queuing. Overall, it is not expected that the transit lane will have a significant impact on vehicular traffic. Improved curb access management will reduce conflicts with parked and loading vehicles, improving the flow of traffic and potentially reducing the incidence of sideswipe collisions on Gottingen Street.

Property Impacts:

No private property acquisition is required.

Stakeholder and Public Consultation

Stakeholder and public consultation were completed to obtain feedback on the detailed design and solicit information related to key design elements including the allocation of on-street parking / loading space and the proposed pedestrian / complete streets enhancements.

Engagement Activities

The following stakeholder and public consultation activities were completed during the detailed design process:

- *Parking / Loading Questionnaire*: A questionnaire related to current parking and loading activities was administered to Gottingen Street businesses and property owners. Staff met with stakeholders individually where available, and circulated the questionnaire to the remaining stakeholders via mail and drop off and through the North End Business Association (NEBA). A total of 29 questionnaires were completed, representing a response rate of 53%.
- *Stakeholder Meeting*: Staff met with local stakeholders including the North End Business Association (NEBA) on Monday, May 14, 2018 at the Halifax North Memorial Public Library. The meeting was attended by more than 18 local stakeholders.
- *Public Open House*: A public Open House was held on Thursday, May 17, 2018, at the Halifax North Memorial Public Library. The meeting was attended by 65 members of the public.
- *On-Street Pop-up Engagement Sessions*: Staff engaged with Gottingen Street users during pop-up engagement sessions on the street during the week of May 14, 2018. Staff engaged with more than 70 people during these pop-up sessions.
- *Online Engagement*: Project materials and a feedback survey were provided via a Shape Your City online consultation page for the project.

Summary of Feedback

Results of the stakeholder and public consultation activities are provided in Appendix D. In general, feedback from stakeholders and the public was mixed. Though there was relatively strong agreement on the need for transit priority on Gottingen Street, the necessary trade-offs did present concerns for some participants. The loss of on-street parking and loading on Gottingen Street was a common concern, along with pedestrian comfort and safety concerns that arise from the addition of a third traffic lane during peak periods.

There was also a considerable amount of feedback on the volume of buses that use Gottingen Street (existing and planned) and the lack of consideration of alternatives that would reduce transit routing on Gottingen Street, including modified route configurations that could use alternate streets such as Barrington Street and Brunswick Street to service buses accessing the Macdonald Bridge. These concerns were noted by staff and will be considered as part of the ongoing review of Macdonald Bridge access options for buses. It should be noted that transit priority measures are still considered critical on Gottingen Street even if some transit vehicles are rerouted to Barrington Street.

Potential complete streets enhancements were an important focus of engagement efforts for the project. Positive feedback was received for the inclusion of complete streets enhancements on the street as part of

the project. There was strong support for several complete streets improvements including trees / planters, benches, garbage cans, curb / sidewalk improvements, and bike parking.

Monitoring and Evaluation Plan:

Monitoring and evaluation of the proposed transit lane will be important in determining the extent to which it achieves desired outcomes (transit service improvement), while understanding the implications for other potential related impacts. A monitoring and evaluation plan has been developed that identifies fourteen metrics focusing on key areas including transit service, mode share, road safety, parking, the street environment, and the impact on adjacent land uses. Table 2 introduces and categorizes the metrics to be monitored, and identifies the desired outcomes. Data and information will be regularly collected at identified time periods and reported on a year after project implementation.

While each of the identified metrics provide valuable insight, it is important to consider some key limitations of their monitoring and evaluation over the short-term. Due to the inherent variability in some of the metrics, year over year observations are not generally a reliable performance indicator. Observation of trends over multiple years is required to develop meaningful conclusions. Also, each metric is influenced by other external factors unrelated to the changes introduced by the proposed bus lane. These limitations should be considered when evaluating the project after implementation.

Further information on the Monitoring and Evaluation Plan including the data sources, data collection methods, and the proposed monitoring and evaluation timelines are provided in Attachment E.

Table 2: Project Evaluation Metrics

#		Metric	Desired Outcome
1	Transit	Change in average transit travel time and reduced variability	Decrease in the average travel time and variability for buses in both directions during peak periods.
2		Rider experience	Improvement in rider experience and support for the project.
3		Transit Operator experience	Improvement in Operator experience and support for the project.
4		Change in ridership	Increase in the ridership for each transit route during peak periods.
5		Change in number of transit related collisions	Decrease in the number of transit-related collisions.
6	All Modes	Change in total person throughput	Increase in the proportion of people traveling by transit as well as walking
7		Cross section allocation	Strong correlation between ROW width assigned to each travel mode and the corresponding mode share
8		Public experience	Improvement in public experience and support for the project.
9		Change in number and severity of collisions	Decrease in the number and severity of collisions.
10		Change in how people are accessing the street	Increase to people accessing the street via transit and active transportation modes.
11	Non-Transit Motorists	Parking / stopping compliance in transit lane	Minimal blockage of the transit lane by parked / stopped vehicles during peak periods.
12		Change in 85 th percentile speed	No significant increase in the 85 th percentile speeds.
13	Street Environment	Number of installed streetscape elements	Increase in the number of streetscaping elements.
14	Parking	Parking utilization	The 85 th percentile parking occupancy is at or less than 85%.

Next Steps / Implementation Plan:

Next steps for the project include the following:

- Transportation Standing Committee and Regional Council approval to proceed with implementation (June-July 2018)
- Collection of baseline evaluation and monitoring data (June-July 2018)
- Consultation with HRM departments including transit operations, parking enforcement, and solid waste other to develop operation strategies for post-implementation
- Tendering and construction (August-October 2018)
- Report to Council concerning the potential for moving northbound express buses to a different route and moving Dartmouth bound express buses to Barrington Street via the Bridge ramp (fall 2018)
- Collection of post-implementation evaluation and monitoring data (periodically, following implementation, for one year)
- Update to Regional Council via Halifax Transit's quarterly reports
- Monitoring and Evaluation Plan report to Regional Council (one year after implementation – anticipated fall 2019)

FINANCIAL IMPLICATIONS

Activities associated with the detailed design will be funded from CM000014 Transit Priority Measures Corridor Study as approved at the March 6, 2018 Regional Council meeting. It is anticipated that construction costs associated with the Gottingen Street transit priority corridor (cost estimate: \$220,000) can be completed using funds in the Transit Priority Measures Implementation project account (CM000009). Funding for select complete streets enhancements (street trees, benches, bicycle parking) is contingent on award of funding from Nova Scotia Energy's Connect2 program or may be included in a future capital budget.

<u>Budget Summary:</u>	<u>Project Account No. CM000009 – Transit Priority Measures</u>	
	Cumulative Unspent Budget	\$712,708
	Less: Construction – Gottingen St. Transit Priority Corridor	<u>\$220,000</u>
	Balance	\$492,708

The balance of funds will be used to implement the remaining 2018/19 and other capital projects as approved by Council.

RISK CONSIDERATION

There are not significant risks associated with the recommendations of this report. The risks considered rate low.

COMMUNITY ENGAGEMENT

A stakeholder / public consultation process was completed as part of the functional design stage, which included stakeholder consultation sessions with several groups (North End Business Association, advocacy groups), a public open house, and online consultation. Results of this consultation process were presented in the March 6, 2018 Regional Council report.

Consultation efforts were furthered as part of the detailed design process, which included direct engagement with Gottingen Street property / business owners, residents, and the general public. The focus of the detailed design community consultation process was to develop a better understanding of parking / loading needs on Gottingen Street to better inform the design, as well as to gauge the community's interest in various streetscape improvement options being considered as part of the project. The consultation

process included open house meetings with the local business community and the general public, as well as on-street pop-up engagement sessions and administration of feedback surveys focused on parking and loading, complete streets elements, and the detailed design. Survey results are summarized in **Attachment D**.

ENVIRONMENTAL IMPLICATIONS

This project is supportive of the Council Priority Outcome of building Healthy, Livable communities, as it aims to make it more convenient for residents to choose sustainable transportation options for everyday transportation purposes. This is reflected in the enhancements for transit, but also the improvements for pedestrians and cyclists.

ALTERNATIVES

1. The Transportation Standing Committee may recommend that Regional Council direct staff to revise the proposed Parking Loss Mitigation Plan as presented in Attachment C. This is not recommended, as the proposed plan minimizes the potential impact to parking and loading without compromising the effectiveness of the transit priority corridor and traffic operations. Revisions to the Parking Loss Mitigation Plan will also require design changes that will delay project implementation.
2. The Transportation Standing Committee may recommend that Regional Council direct staff to revise the proposed Monitoring and Evaluation Plan as presented in Attachment E. This is not recommended as it represents a comprehensive list of metrics that will play a key role in assessing project outcomes.
3. The Transportation Standing Committee may recommend that Regional Council direct staff to revise the detailed design drawings in Attachment B. This is not recommended as it will delay the implementation of a Council approved project beyond the 2018 construction season.

ATTACHMENTS

Attachment A: *Transportation Standing Committee Report: Transit Priority Corridors: Gottingen Street / Bayers Road* (January 25, 2018)

Attachment B: Detailed Design Drawings – Gottingen Street

Attachment C: Parking Loss Mitigation Plan

Attachment D: Community Consultation Results Summary

Attachment E: Monitoring and Evaluation Plan

A copy of this report can be obtained online at halifax.ca or by contacting the Office of the Municipal Clerk at 902.490.4210.

Report Prepared by: Mike Connors, P.Eng., Transportation Engineer, Planning & Infrastructure, 902.817.0795



P.O. Box 1749
Halifax, Nova Scotia
B3J 3A5 Canada

Attachment A

Item No. 14.3.1
Halifax Regional Council
March 6, 2018

TO: Mayor Savage and Members of Halifax Regional Council

Original Signed

SUBMITTED BY: _____
Councillor Tim Outhit, Chair, Transportation Standing Committee

DATE: February 23, 2018

SUBJECT: Transit Priority Corridors: Gottingen Street

ORIGIN

February 22, 2018 meeting of the Transportation Standing Committee, Item No. 8.1.

LEGISLATIVE AUTHORITY

Administrative Order 1, Respecting the Procedures of the Council, Schedule 7, Transportation Standing Committee Terms of Reference, section 4 (d):

Duties and Responsibilities

4. The Transportation Standing Committee shall oversee and review of the Municipality's Regional Transportation Plans and initiatives, as follows: providing input and review of the Transportation Road network strategies and related Regional initiatives.

RECOMMENDATION

That the Transportation Standing Committee recommends that Halifax Regional Council proceed with detailed design of a continuous northbound bus lane on the Gottingen Street corridor at peak (7am-9am and 3pm-6pm, Monday to Friday), with a provision for intermittent northbound transit priority measures off peak, that will include allowing short duration time regulated (15-90 minute) parking and loading where appropriate, and to return to the Transportation Standing Committee with:

1. A Parking Loss Mitigation Plan which includes engagement with the public and stakeholders, returning with a recommendation prior to tendering the project;
2. A supplementary report regarding the potential for moving northbound express buses (as planned) to a different route and moving Dartmouth bound express buses to Barrington Street via the Bridge ramp.
3. A plan to measure and evaluate the impact of the project and recommend changes, if any, within one year of implementation.

BACKGROUND

A staff report dated January 25, 2018 pertaining to Transit Priority Corridors for Gottingen Street was before the Transportation Standing Committee for consideration at its meeting held on February 22, 2018.

For further information, please refer to the attached staff report dated January 25, 2018.

DISCUSSION

Staff provided a presentation and responded to questions of clarification from the Transportation Standing Committee in relation to the proposed Transit Priority Corridors for Gottingen Street. The Transportation Standing Committee forwarded an alternative recommendation to Halifax Regional Council as outlined in this report.

FINANCIAL IMPLICATIONS

As outlined in the attached staff report dated January 25, 2018.

RISK CONSIDERATION

As outlined in the attached staff report dated January 25, 2018.

COMMUNITY ENGAGEMENT

The Transportation Standing Committee meetings are open to public attendance, a live webcast is provided of the meeting, and members of the public are invited to address the Committee for up to five minutes at the end of each meeting during the Public Participation portion of the meeting. The agenda, reports, video, and minutes of the Transportation Standing Committee are posted on Halifax.ca.

ENVIRONMENTAL IMPLICATIONS

As outlined in the attached staff report dated January 25, 2018.

ALTERNATIVES

The Transportation Standing Committee considered an alternative recommendation as outlined in the recommendation section of this report. Additional alternative recommendations are outlined in the January 25, 2018 staff report.

ATTACHMENTS

1. Staff report dated January 25, 2018.

A copy of this report can be obtained online at halifax.ca or by contacting the Office of the Municipal Clerk at 902.490.4210.

Report Prepared by: Liam MacSween, Legislative Assistant, 902.490.6521.



P.O. Box 1749
Halifax, Nova Scotia
B3J 3A5 Canada

Attachment 1
Transportation Standing Committee
February 1, 2018
February 22, 2018

TO: Chair and Members of Transportation Standing Committee

ORIGINAL SIGNED

SUBMITTED BY:

Kelly Denty, Acting Director: Planning & Development

ORIGINAL SIGNED

Dave Reage, Director: Halifax Transit

DATE: January 25, 2018

SUBJECT: Transit Priority Corridors: Gottingen Street / Bayers Road

ORIGIN

- The Halifax Transit *Moving Forward Together Plan*, approved by Regional Council in April 2016, identified Bayers Road and Gottingen Street as critical choke points for transit service into and out of downtown Halifax that require transit priority.
- At the June 21, 2016 meeting of Regional Council, staff were directed to submit 16 proposed transit projects for cost-shared funding approval under the Public Transit Infrastructure Fund (PTIF). One of those projects proposed was the Transit Priority Corridors project.
- At the February 21, 2017 meeting of Regional Council, Halifax Regional Council authorized the Mayor and Municipal Clerk to sign the fifteen Contribution Agreements with the Minister of Municipal Affairs, to receive funding for public transit projects approved under the Public Transit Infrastructure Fund (PTIF), including one for the Transit Priority Corridors project.
- In May 2017, RFP 17-303 was awarded to WSP Canada Inc. to prepare functional designs for 'Transit Priority Corridors' on Bayers Road (Romans Avenue to Windsor Street) and Gottingen Street (North Street to Cogswell Street).
- At the December 5th, 2017 meeting of Regional Council, the Integrated Mobility Plan was approved, and staff were directed to include an implementation plan in the upcoming staff report for the Bayers Road and Gottingen Street Transit Priority corridors functional design to allow Council to consider construction in fiscal 2019/20.

LEGISLATIVE AUTHORITY

Transportation Standing Committee Terms of Reference, section 4 (a) which states: "The Transportation Standing Committee shall oversee and review the Municipality's Regional Transportation Plans and initiatives, as follows: overseeing HRM's Regional Transportation Objectives and Transportation outcome Areas".

Halifax Regional Municipality Charter, subsection 318(2): “In so far as is consistent with their use by the public, the Council has full control over the streets in the Municipality.”

Halifax Regional Municipality Charter, subsection 322(1): “The Council may design, lay out, open, expand, construct, maintain, improve, alter, repair, light, water, clean, and clear streets in the Municipality.”

RECOMMENDATION

It is recommended that the Transportation Standing Committee recommend that Halifax Regional Council:

1. Proceed with detailed design of a dedicated northbound bus lane on the Gottingen Street corridor, including a Parking Loss Mitigation Plan which includes engagement with the public and stakeholders, and return to Council with a recommendation prior to tendering the project.
2. Proceed with detailed design of dedicated bus lanes in both directions on the Bayers Road corridor, including reconfiguration of the Halifax Shopping Centre intersection.

EXECUTIVE SUMMARY

The Halifax Transit *Moving Forward Together Plan* (MFTP), approved by Regional Council in April 2016, identifies Bayers Road and Gottingen Street as critical choke points for transit service that require transit priority. To improve transit service on these corridors, the MFTP recommends investment in transit priority measures (TPMs) that provide priority to the movement of buses over general traffic. These recommendations have been further reinforced by policy direction in the recently adopted *Integrated Mobility Plan* (IMP). When the IMP was adopted in December 2017, Regional Council also directed staff to include an implementation plan for Bayers Road and Gottingen Street so that Council could consider construction in fiscal 2019/20.

The physical characteristics of the corridors, as well as how people use them, have a major influence on the type of transit priority measures that can be implemented. Also, as is typical with any project that involves reconfiguration of an existing street, there are trade-offs that need to be considered. Where right-of-way expansion is necessary, there may be impacts to utilities, private property, and other infrastructure. Loss of traffic lanes and curb access used for on-street parking, loading, and stopping may also be necessary. These impacts are consistent with the IMP, which notes that parking management should be aligned with the goal of shifting more trips to active transportation, transit and car-sharing, while supporting growth in the Regional Centre. Effectively managing the supply of parking can help to influence travel habits and improved parking efficiency can reduce the amount of space needed for parking. As an initial phase of detailed design, a Parking Loss Mitigation Plan will be carried out in consultation with local Gottingen Street businesses to help ensure that adequate short-duration parking is provided for this important commercial area.

Following approval of the MFTP and securement of funding support from the Public Transit Infrastructure Fund (PTIF), a consultant was retained in May 2017 to complete a functional design study for transit priority corridors on Bayers Road and Gottingen Street. Multiple design options were completed for each corridor, representing a range of investment scenarios. The design options were evaluated based on various criteria that considered the potential to improve transit operation, multimodal impacts (walking, bicycling, traffic), curbside impacts (parking, loading), implementation cost, and the feedback received from stakeholders and the public. Analysis was also completed to relate capital / operational costs to operational benefits and develop an understanding of the cost-effectiveness of each option.

Based on the findings of the functional design study, this report recommends that both the Bayers Road and Gottingen Street transit priority corridors be advanced to the detailed design stage. The recommended configuration for Gottingen Street includes a continuous northbound transit lane between Cogswell Street and North Street. The recommended configuration for Bayers Road includes continuous dedicated transit

lanes in both directions between Romans Avenue and Windsor Street. These recommendations, which will provide considerable improvements for transit service, are in accordance with the objectives of the MFTP and the IMP.

With approval of the recommendations in this report, the proposed transit priority corridors will move to the detailed design stage, which will provide further opportunity to refine the details of the corridor configuration and develop a comprehensive understanding of the implications of constructing the corridors. It is anticipated that detailed design will be completed using a combination of HRM staff resources and an external consultant, and will involve public and stakeholder engagement. Upon completion of the detailed design process, implementation will be subject to budget availability and approval of construction tenders by the CAO.

A projected implementation timeline has been developed for both the Gottingen Street and Bayers Road corridors. The recommended Gottingen Street transit priority corridor does not require property acquisition or significant construction works; therefore, it is anticipated that implementation can be completed during 2018. The recommended Bayers Road transit priority corridor configuration will require property acquisition and involves extensive construction works – it is possible that construction could be completed by 2020; however, there is potential that property acquisition could delay implementation beyond this timeframe.

BACKGROUND

The Halifax Transit *Moving Forward Together Plan* (MFTP), approved by Regional Council in April 2016, identifies Bayers Road and Gottingen Street as critical choke points for transit service into and out of downtown Halifax that require transit priority. To improve transit service on these corridors, the MFTP recommends investment in transit priority measures (TPMs) that provide priority to the movement of buses over general traffic.

In February 2017, Regional Council directed staff to enter into a contribution agreement with the federal government, under the Public Transit Infrastructure Fund (PTIF), for a project to study and design 'Transit Priority Corridors' on Bayers Road and Gottingen Street. The total project budget is \$250,000, the cost of which is being shared evenly between the municipality and federal government. The project, CM000014 Transit Priority Measures Corridor Study, is to be completed in two phases: a functional design study that identifies and evaluates design alternatives (Phase 1), followed by detailed design based on the preferred design options for the two corridors (Phase 2).

In May 2017, RFP 17-303 was awarded to WSP Canada Inc. (contract value \$133,664) to prepare functional designs for 'transit priority corridors' on Gottingen Street (North Street to Cogswell Street) and Bayers Road (Romans Avenue to Windsor Street), with the option to undertake the design of two further corridors pending direction from Regional Council through the Integrated Mobility Plan (IMP).

On December 5, 2017, Regional Council approved the IMP, which includes direction to prioritize the delivery of transit priority corridors on Bayers Road, Gottingen Street, Robie Street, and Young Street.

This report represents the conclusion of Phase 1 of this project.

Gottingen Street:

Gottingen Street is an arterial road that runs north-south between downtown Halifax and the north end of the Halifax peninsula. It has a diverse mixture of land uses, and recent, ongoing, and planned development projects are rapidly increasing the density of residential and commercial uses on the street. A key roadway linking downtown to the Macdonald Bridge and points further north, Gottingen Street has daily traffic volumes exceeding 8,500 vehicles per day. There is limited available right-of-way on Gottingen Street, and physical widening of the street or right-of-way is not a viable alternative.

Transit on Gottingen Street

There are currently 18 Halifax Transit routes that travel on Gottingen Street, totalling 79 buses per hour (2-way) during the peak hour. Planned changes in the MFTP will increase the number of buses using Gottingen Street to a total of 90 during the peak hour. Some routes along Gottingen Street provide limited stops, and two routes do not stop at all between Cogswell Street and North Street. Transit service on Gottingen Street is hindered by traffic congestion during peak periods, as well as by the need for buses to manoeuvre around vehicles stopped or parked in the curb lanes throughout the day. The relatively narrow street width makes these manoeuvres particularly challenging, and transit vehicles are delayed an average of 5-6 minutes in the northbound direction during the afternoon peak hour. These delays can be significantly higher when incident-related traffic congestion occurs.

Bayers Road

Bayers Road is an arterial road that runs east-west between Joseph Howe Drive and Windsor Street. It is characterized mostly by single family homes, and there are also several commercial properties found along the length of the corridor including the Halifax Shopping Centre. A key link in the regional roadway network, Bayers Road accommodates more than 40,000 vehicles per day. Traffic congestion is prevalent during peak periods, often resulting in significant delays.

The 2014 *Regional Municipal Planning Strategy* identifies expansion of the Bayers Road corridor for mixed traffic as a planned project to occur in conjunction with expansion of Highway 102 (Hammonds Plains Road to Bayers Road) by the Province. Specifically, this includes widening from four lanes to six lanes west of Connaught Avenue and widening from three lanes to four lanes between Connaught Avenue and Windsor Street. Though the corridor expansion has not yet been programmed for implementation, for several years the Municipality has been making strategic property acquisitions along Bayers Road to preserve the corridor. At present, most of the properties on either side of the section of Bayers Road between Highway 102 and Connaught Avenue are owned by HRM.

Transit on Bayers Road

At present, seven Halifax Transit routes travel on Bayers Road, totalling more than 40 buses per hour (2-way) during the peak hour. Planned changes in the MFTP will increase the number of buses using Bayers Road during the peak hour. Traffic congestion on Bayers Road has significant impacts to transit and reduces Halifax Transit's ability to provide a high quality, reliable service. Routes on Bayers Road regularly experience significant delays during peak periods – particularly during the afternoon – and at present, some trips on the Route 1 detour in the outbound direction on Roslyn Road to reduce delay.

Transit Priority Corridors

Bayers Road and Gottingen Street were identified as proposed transit priority corridors in the MFTP based on their importance for existing and planned transit operations, as well as the potential that they are expected to offer for providing priority to transit over general traffic. The type of transit priority proposed for the corridors was not identified in the Plan, recognizing that there are many factors that need to be considered in determining a preferred approach. The physical characteristics of the corridors, as well as how people use them, have a major influence on the type of transit priority measures that can be implemented.

Also, as is typical with any project that involves reconfiguration of an existing street, there are trade-offs that need to be considered. Where right-of-way expansion is necessary, impacts to private property and other infrastructure (e.g. water & sewer, power / communications lines, trees) may be required. Loss of traffic lanes and curb access used for on-street parking, loading, and stopping may also be necessary. These impacts are consistent with the IMP, which notes that parking management should be aligned with the goal of shifting more trips to active transportation, transit and car-sharing, while supporting growth in the Regional Centre. Effectively managing the supply of parking can help to influence travel habits and improved parking efficiency can reduce the amount of space needed for parking. As an initial phase of detailed design, a Parking Loss Mitigation Plan will be carried out in consultation with local Gottingen Street businesses to help ensure that adequate short-duration parking is provided for this important commercial area.

DISCUSSION

Following approval of the MFTP and securement of funding support from the Public Transit Infrastructure Fund (PTIF), Phase 1 of the project commenced after the selection of a consultant in May 2017 to complete a functional design study for the corridors. The primary objective of Phase 1 of the project was to investigate transit priority options and develop functional designs for transit priority corridors for Gottingen Street and Bayers Road. The scope of the consultant’s work included the following:

- Detailed investigation of existing conditions along each corridor and review of existing and projected multimodal transportation demands;
- Develop 2-3 conceptual design options representing a range of investment levels with input from the project steering committee and feedback from stakeholders;
- Public and stakeholder engagement related to the proposed design concepts;
- Identify any necessary property acquisition and utility relocation requirements for each option
- Evaluate multimodal level of service for the options that considers factors such as transit operational benefits, intersection performance impacts, parking / curb access, and road safety.

The consultant's findings and recommendations have been summarized in a design report appended to this report in **Attachment E**.

An overview of the Gottingen Street and Bayers Road corridors and the options considered for each are provided in **Attachment A** and **Attachment B**, respectively. The recommended options are summarized in the following sections:

Gottingen Street

Analysis Approach and Identification of Preferred Configuration

Options representing varying levels of investment (low, medium, and high) were considered for the proposed Gottingen Street transit priority corridor. A summary of the options that were considered is provided in **Attachment A** and further detailed in the consultant’s report in **Attachment E**. The preferred configuration for the Gottingen Street transit priority corridor, as summarized in Table 1, includes a dedicated northbound transit lane. Further detail and functional design sketches are provided on Pages 5-7 (**Attachment C**).

Table 1: Preferred Configuration Option – Gottingen Street Transit Priority Corridor

	Functional Sketch	Summary
Cogswell Street to North Street	 <p><i>Gottingen Street (looking to the south)</i></p>	<ul style="list-style-type: none"> • Continuous outbound (northbound) lane for buses only (also permitted for use by right turning vehicles); • Installation of pedestrian signals at key pedestrian crossings; • Removal of on-street parking and loading

Summary of Impacts:

A summary of the impacts associated with the recommended transit priority corridor option for Gottingen Street is provided below:

- *Transit Service:* Significant transit improvement in the northbound direction. Buses avoid obstruction by parked cars and can bypass lengthy queues, reducing delay and improving reliability. It is estimated that these corridor-level transit priority measures will substantially reduce delay for northbound buses, benefiting approximately 1600 peak hour passengers over 56 trips.

During heavily congested periods, it is estimated that buses will experience significant reductions in delay – running times on Gottingen Street suggest that buses are regularly delayed by 5-6 minutes during the PM peak, and in some cases up to 15 minutes. The proposed transit priority corridor will enable buses to avoid these major delays, which will improve schedule adherence during congested periods and play an important role in making the service more attractive to users.

- *Active Transportation:* Minimal impacts. The addition of signalized crosswalks improves street crossing experience.
- *Traffic Impacts:* Slight improvement to traffic flow due to removal of on-street parking.
- *Property Impacts:* No impacts to private property.
- *Parking / Loading:* Removal of all on-street parking and loading on Gottingen Street (51 spaces). There may be potential to allow short-term parking or loading during overnight hours when buses are not running. A 'Parking Loss Mitigation Plan' will be included in the detailed design stage of the project. Work on the plan has already begun and will include further engagement with local businesses. The plan will determine actual parking demand and will identify areas where it can be accommodated in the immediate vicinity, including additional parking on side streets.

Summary of Stakeholder and Public Consultation Feedback:

The Gottingen Street concept options were presented to the public at an Open House on Monday, October 2nd, 2017, and a Shape Your City online consultation page was established. Feedback on the design options was obtained (via survey) from a total of 296 members of the public. Results are provided in **Attachment D**. The addition of transit priority on Gottingen Street was deemed favorable by more than 60% of survey respondents. Among the potential trade-offs associated with implementation of the presented options (parking / loading, traffic congestion, increased bus traffic, and implementation costs), the leading concerns were increased traffic congestion, loss of loading access, and increased bus traffic on the street. However, none of the trade-offs were deemed unacceptable by most respondents.

HRM consulted with representatives from the North End Business Association (NEBA) on July 26th, 2017, to introduce the project and develop an understanding of the priorities and concerns of the local business community. The NEBA is concerned about how the project may impact Gottingen Street businesses and raised the following items for consideration:

- ***The potential loss of on-street parking and loading on Gottingen Street and its perceived impact on the viability of local businesses:*** As noted above, the detailed design stage of the project will include a 'Parking Loss Mitigation Plan' that includes a parking utilization study for Gottingen Street and the surrounding streets. While it is likely that there will be some net loss of on-street parking, this is consistent with curbside priority direction provided by the IMP, which prioritizes transit lanes over on-street parking and acknowledges the importance of replacing lost on-street parking where possible. Loading spaces will continue to be accommodated.
- ***The volume of buses that use Gottingen Street (existing and planned), and its perceived detrimental impact on the public realm:*** The public realm on Gottingen Street benefits from the significant number of people that buses bring to the street; this is also true for the businesses. Added transit priority will enable buses to move through the corridor more efficiently, thereby reducing the amount of bus idling on Gottingen Street while in traffic.
- ***The lack of consideration of alternatives that would reduce transit routing on Gottingen Street, including modified route configurations that could use alternate streets such as Barrington Street and Brunswick Street to service buses accessing the Macdonald Bridge (bus access to the bridge via these streets is constrained by the current ramp configuration):*** At present, Dartmouth bound buses must use Gottingen Street to access the Macdonald Bridge. Due to geometry on the Barrington Street ramp to the Macdonald Bridge, transit vehicles are unable to use this access. The Municipality and the Bridge Commission continue to work closely to investigate viable options that would permit this movement in a way that is safe, and enables buses to travel to Dartmouth from Halifax via Barrington Street. Interventions may be limited to small changes to the geometry of some road markings, however it is possible that it could require larger changes to the bridge ramp, which may be extremely costly.

However, even if the Barrington Street ramp did provide access for Dartmouth bound buses to the bridge, transit priority is still warranted on Gottingen Street for the buses which would still serve the many residents and businesses on this important corridor. There is high passenger demand on Gottingen Street: and this area is very walkable and is characterized by businesses and services which attract transit passengers and pedestrians alike. If the Barrington Street ramp were to be accessible to transit vehicles, only routes that do not currently make stops on Gottingen Street would benefit.



Brunswick Street is not considered a candidate for routing transit vehicles at this time. This street is a local street between Cogswell Street and North Street with lower traffic volumes, and the character of the street is largely residential. It lacks the commercial usage that Gottingen Street has, and thus does not have the same trip demand, attractions, or destinations. It is not currently possible for any vehicles to access the Macdonald bridge from Brunswick Street. At best, with the necessary intersection modifications at North Street, Brunswick Street could only accommodate buses travelling to Dartmouth and would not eliminate the need for transit priority on Gottingen Street.

Bayers Road

Analysis Approach and Identification of Preferred Configuration

Bayers Road was analyzed based on three distinct sections: (i) Romans Avenue to Halifax Shopping Centre, (ii) Halifax Shopping Centre and Connaught Avenue, and (iii) Connaught Avenue to Windsor Street. Multiple options representing varying levels of investment (low, medium, and high) were considered for the configuration of the proposed transit priority corridors for each section of Bayers Road. A summary of the options that were considered is provided in **Attachment B** and further detailed in the consultant's report in **Attachment E**. The preferred configuration for each of the three sections of Bayers Road are summarized in Table 2. Further detail and functional design sketches are provided on Pages 1-4 (**Attachment C**).

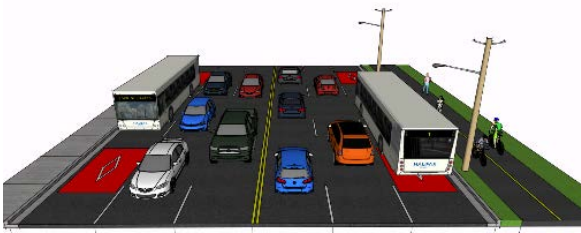
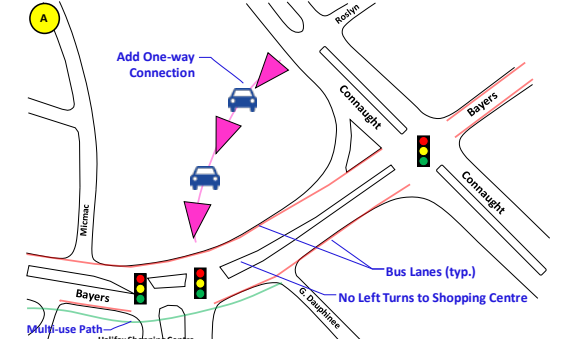
Table 2: Preferred Configuration Options – Bayers Road Transit Priority Corridor

	Functional Sketch	Summary
<p>Romans Avenue to Halifax Shopping Centre</p>	 <p><i>Bayers Road (looking to the east)</i></p>	<ul style="list-style-type: none"> • Widen from existing 4-lane cross section to a 6-lane cross section; • Add continuous eastbound and westbound dedicated bus lanes (also permitted for use by right turning vehicles); • Add a multi-use pathway on the south side of Bayers Road; • Most of required land has already been acquired by HRM, though more property acquisition will be required.
<p>Halifax Shopping Centre to Connaught Avenue</p>		<ul style="list-style-type: none"> • Left turns into Halifax Shopping Centre prohibited from Bayers Road, removing key source of congestion. • Add new one-way driveway connection to the Halifax Shopping Centre across HRM-owned vacant parcel. New connection provides increased capacity for traffic entering the Halifax Shopping Centre. Further consultation with the Halifax Shopping Centre will be required. • Add continuous eastbound and westbound dedicated bus lanes (also permitted for use by right turning vehicles);
<p>Connaught Avenue to Windsor Street</p>	 <p><i>Bayers Road (looking to the east)</i></p>	<ul style="list-style-type: none"> • Widen from existing 3-lane cross section to a 4-lane cross section; • Add continuous eastbound and westbound dedicated bus lanes (also permitted for use by right turning vehicles); • Property acquisition will be required. Several properties are affected, though it is not anticipated that impacts will be extensive. Removal of on-street parking and loading.

Summary of Impacts:

A summary of the impacts associated with the recommended transit priority corridor option for Bayers Road is provided below:

- **Transit Service:** Significant transit improvement in both directions, as buses avoid the traffic congestion that frequently occurs during peak periods. For example, it is estimated that these corridor-level transit priority measures will substantially reduce delay for outbound buses during the PM peak – running times on Bayers Road suggest that buses are regularly delayed by 13-14 minutes during the PM peak, and in some cases by up to 28 minutes (these improvements would benefit approximately 530 peak hour passengers, over 25 trips). The proposed transit priority corridor will enable buses to avoid these major delays, which will improve schedule adherence during congested periods and play an important role in making the service more attractive to users.
- **Active Transportation:** Multi-use path west of Connaught Avenue provides improved walking / cycling connection.
- **Traffic Impacts:** Slight improvement to traffic flow due to removal of buses from general traffic and decreased delay at the reconfigured Halifax Shopping Centre driveway intersection. The closely spaced intersections at Connaught Avenue and Bayers Road would benefit considerably from the intersection configuration, reducing confusion and operational challenges for all users.

- *Property Impacts:* Widening in constrained areas will require property acquisition. West of the Halifax Shopping Centre, most of required land has already been acquired by HRM, though more property acquisition will be required. East of Connaught Avenue, several properties may be affected, though the majority will not be significantly impacted (narrow strips of property frontage required).
- *Parking / Loading:* Loss of approximately 50 on-street parking spaces on Bayers Road between Connolly Street and Dublin Street.

Summary of Stakeholder and Public Consultation Feedback:

The Bayers Road corridor concept options were presented to the public at an Open House on Thursday, September 28th, and a Shape Your City online consultation page was established. Feedback on the design options was obtained (via survey) from a total of 488 members of the public. Results are provided in **Attachment D**. The addition of dedicated bus lanes on Bayers Road received a favorable response from more than 70% of respondents. Among the potential trade-offs associated with implementation of the presented options (property impacts, parking / loading, traffic congestion, increased bus traffic, and implementation costs), the potential for increased traffic congestion was the lone category that most respondents (54%) indicated was unacceptable.

HRM consulted with representatives from the Halifax Shopping Centre to review the concept options as they relate to the shopping centre driveway intersection. Based on preliminary feedback, Halifax Shopping Centre representatives have concerns about potential modifications to the existing access configuration, but indicated that they are open to further consultation as the project progresses.

Recommended Approach for the proposed Transit Priority Corridors:

It is recommended that both the Bayers Road and Gottingen Street Transit Priority Corridors be advanced to the detailed design stage. The recommended configuration for each corridor is described below:

Gottingen Street: Continuous northbound transit lane between Cogswell Street and North Street. Since the Gottingen Street options are quite scalable (most of the changes include modifications to signage, signals, and pavement markings and do not require land acquisition or have significant impacts to physical infrastructure), the recommended option could be modified relatively easily depending on how the facility operates and/or how its impacts to the street are perceived. Consideration could also be given to permitting on-street parking in the transit lane during specific periods with limited transit service such as overnight. Recommendations from the Parking Loss Mitigation Plan noted above will be included in the detailed design.

Bayers Road: Dedicated bus lanes (both directions) on Bayers Road between Romans Avenue and Windsor Street, and reconfiguration of the Halifax Shopping Centre intersection to include a new at-grade access leg via the HRM-owned vacant property at 6699 Bayers Road. During the detailed design process, further investigation should be completed to determine a preferred intersection configuration for the Halifax Shopping Centre driveway. Consultation with representatives from the Halifax Shopping Centre should also be continued during the design process.

Next Steps / Implementation Plan

At the February 21, 2017 meeting of Regional Council, Halifax Regional Council directed staff to provide an implementation plan for the Gottingen Street and Bayers Road corridors that allows consideration of the potential for construction during the 2019-20 fiscal year. The following describes the next steps that are anticipated to be required for implementation of both corridors.

Gottingen Street:

Based on Regional Council approval of the recommendations outlined in this report, an approximate implementation timeline is summarized in Table 3. Detailed design of the transit priority corridor will be completed by HRM staff. During detailed design, public and stakeholder engagement will be completed to provide opportunity for additional feedback on the design and related impacts.

Implementation of the recommended Gottingen Street transit priority corridor does not require property acquisition or significant construction works; therefore, it is anticipated that implementation can be completed during 2018.

Table 3: Estimated Implementation Timeline - Gottingen Street Transit Priority Corridor

Task	2018							
	J	F	M	A	M	J	J	A
1. Detailed Design ^{a b}								
2. Construction Tendering								
3. Award of Construction Tender ^c								
4. Construction								
Notes:								
a. Assumes Regional Council approval of staff recommendations in February 2018.								
b. Detailed design completed by HRM Planning & Development and Transportation & Public Works.								
c. CAO award of construction tender will be subject to budget availability.								

Bayers Road:

Based on Regional Council approval of the recommendations outlined in this report, an approximate implementation timeline is summarized in Table 4. Implementation of the Bayers Road transit priority corridor is significantly more complex than for Gottingen Street, and will require additional time, budget, and resources. Due to the anticipated need to acquire private property, there is also more schedule uncertainty.

A consultant will be retained to complete detailed design. During detailed design, public and stakeholder engagement will be completed to provide opportunity for additional feedback on the design and related impacts. Based on the detailed design, property acquisition requirements will be identified, and a construction budget estimate will be developed. The process of acquiring private property will have uncertain timelines that could delay the project. Award of a construction tender by the CAO will be required, subject to budget availability. Construction timelines are also uncertain, though it is expected that at least 3-4 months will be required.

Based on the estimated implementation timeline, it appears possible that construction of the proposed Bayers Road transit priority corridor can be completed by 2020. However, it is noted that certain elements of the implementation process – primarily property acquisition – do have the potential to delay the project to 2021 or beyond.

Table 4: Estimated Implementation Timeline - Bayers Road Transit Priority Corridor

Task	2018				2019				2020			
	Winter	Spring	Summer	Fall	Winter	Spring	Summer	Fall	Winter	Spring	Summer	Fall
1. Issue and Award RFP for Detailed Design ^a												
2. Detailed Design ^b												
3. Property Acquisition ^c												
4. Construction Tendering												
5. Award of Construction Tender ^d												
6. Construction ^e												

Notes:

- Assumes Regional Council approval of staff recommendations in February 2018.
- Detailed design completed by consultant.
- Property acquisition requirements will be determined based on the detailed design. The process of acquiring private property has uncertain timelines, and may vary considerably depending on the amount of property required.
- CAO award of construction tender will be subject to budget availability.
- Construction timelines for this project are uncertain. Mitigation of construction-related impacts on traffic will likely be desired due to the significance of the Bayers Road corridor. It has been assumed that construction will commence during spring, coinciding with the start of the road construction season.

Robie Street / Young Street: As recommended in the IMP, transit priority corridors are also being investigated on Robie Street and Young Street. Staff are currently working with WSP Canada Inc. on a functional design study for the two corridors. The design process will include public engagement in February 2018. Upon completion of the functional design study, a recommendation report will be submitted to Regional Council seeking direction to proceed to detailed design for a recommended corridor configuration. This report will also describe an estimated timeline for implementation of these corridors, which may include phasing. It is anticipated that the report will be submitted to Regional Council in spring 2018.

FINANCIAL IMPLICATIONS

The evaluation of the corridor options considered both capital and operating costs relative to operational benefits in identifying a preferred, cost-effective approach. The detailed design for Bayers Road will be funded from CM000014 Transit Priority Measures Corridor Study, the cost of which is estimated to be within the balance of \$116,336 available in the project account. The Bayers Road detailed design is funded through the Public Transit Infrastructure Fund (PTIF), which provides up to 50% of the project costs. The detailed design work for Gottingen Street will be undertaken by HRM staff resources at no additional cost to the Municipality.

Budget Summary: Project Account No. CM000014 Transit Priority Measures Corridor Study

Cumulative Unspent Budget	\$ 116,336
Less: estimated detailed design cost	<u>\$(116,336)</u>
Balance	\$ 0

The Gottingen Street transit priority corridor construction work – estimated at approximately \$250,000, but subject to detailed design – will be funded from project account CM000009, Transit Priority Measures, pending the approval of the 2018/19 capital budget.

Budget Summary: Project Account No. CM000009 Transit Priority Measures

Cumulative Unspent Budget	\$392,390
Anticipated 2018/19 Budget	\$350,000
Less: estimated construction cost	<u>\$(250,000)</u>
Balance	\$ 492,390

Construction of the recommended Bayers Road transit priority corridor is not budgeted at this time – the preliminary Class D cost estimate for construction, excluding property acquisition, is \$4.8 million – but the design will allow tender/construction to proceed when the funding opportunity/decision occurs.

RISK CONSIDERATION

There are no significant risks associated with the recommendations of this report. The risks considered rate low.

COMMUNITY ENGAGEMENT

Stakeholder and public consultation was completed to develop an understanding of the key issues on each corridor and solicit feedback on the presented concept designs.

- Stakeholder consultation sessions were held with the following groups:
 - North End Business Association
 - Halifax Shopping Centre (20Vic Management)
 - Halifax Cycling Coalition
 - It's More Than Buses
 - Walk & Roll
 - Canadian National Institute for the Blind (CNIB)
 - Dalhousie Transportation Collaboratory (DalTrac)

The information obtained from these groups was considered during the development of the design options, and incorporated into the options evaluation process.

- Public open consultation sessions were held for each of the Gottingen Street and Bayers Road corridors:
 - Bayers Road: Thursday, September 28th – Maritime Hall
 - Gottingen Street: Monday, October 2nd – George Dixon Centre

In addition, a Shape Your City online engagement portal was established for each corridor. Feedback was collected via in-person comments, a paper feedback survey, and an online survey (there were a total of 488 respondents for the Bayers Road survey, and 296 respondents for the Gottingen Street survey). The information obtained from public consultation was used to develop an understanding of priorities on each corridor and evaluate public response to the design options. Survey results are summarized in **Attachment D**.

Further engagement with Gottingen Street businesses, relative to on-street parking and loading impacts and the Halifax Shopping Centre, relative to its intersection at Bayers Road, will continue for both projects as they proceed through the detailed design process.

ENVIRONMENTAL IMPLICATIONS

This project is supportive of the Council Priority Outcome of building Healthy, Livable communities, as it aims to make it more convenient for residents to choose sustainable transportation options for everyday transportation purposes. This is reflected in the enhancements for transit, but also the improvements for

pedestrians and cyclists.

ALTERNATIVES

The Transportation Standing Committee may recommend to Regional Council that some or all of the recommendations not be approved or be modified. Alternatives for each of the Gottingen Street and Bayers Road and corridors are presented below:

Gottingen Street:

1. The Committee may recommend that Regional Council direct staff to introduce a 12-month pilot of a northbound transit lane on Gottingen Street in order to observe and monitor the impacts it may have on transit service reliability as well as local businesses and residents. This alternative is not recommended, as the transit benefits of the proposed measures are well understood at this time, and more than 60% of consultation survey respondents showed support for the measures.
2. The Committee may recommend that Regional Council direct staff to proceed to detailed design of intermittent transit priority measures in the northbound direction. This alternative is not recommended; while it does provide transit priority benefits, the overall transit benefit is considerably less than the continuous priority included in the high investment option, and the additional cost is only marginally lower.
3. The Committee may recommend that Regional Council direct staff to implement peak period parking / loading restrictions or recommend that no changes be made to the Gottingen Street corridor. These alternatives are not recommended, as they do not provide transit priority benefits contemplated by the MFTP and IMP.

Bayers Road:

1. The Committee may recommend that Regional Council direct staff to proceed to detailed design of dedicated bus lanes (both directions) on Bayers Road without reconfiguration to the Halifax Shopping Centre intersection. This alternative is not recommended, as it is not expected that effective transit priority can be provided through the section between Halifax Shopping Centre and Connaught Avenue under the existing intersection configuration.
2. The Committee may recommend that Regional Council direct staff to proceed to detailed design of a dedicated westbound bus lane on Bayers Road between Romans Avenue and Windsor Street. This alternative is not recommended, since it provides transit priority only in the outbound direction and does not achieve the benefits contemplated by the MFTP and IMP.
3. The Committee may recommend that Regional Council make no changes to the Bayers Road corridor. This alternative is not recommended, as it does not achieve the benefits contemplated by the MFTP and IMP.

ATTACHMENTS

Attachment A: Gottingen Street Summary and Design Options Overview

Attachment B: Bayers Road Summary and Design Options Overview

Attachment C: Functional Design Drawings

Attachment D: Community Consultation Results Summary

Attachment E: *Halifax Transit Priority Corridors: Gottingen Street and Bayers Road* (WSP, November 2017)

A copy of this report can be obtained online at halifax.ca or by contacting the Office of the Municipal Clerk at 902.490.4210.

Report Prepared by: Mike Connors, P.Eng., Transportation Engineer, Planning & Infrastructure, 902.817.0795

Report Approved by: Patricia Hughes, Manager Planning & Scheduling, Halifax Transit 902.490.6287

Report Approved by: Peter Duncan, Manager Infrastructure Planning, Planning & Development, 902.490.5449

Attachment A: Gottingen Street Summary and Options Overview

The Gottingen Street corridor was investigated between North Street and Cogswell Street (See Figure 1).

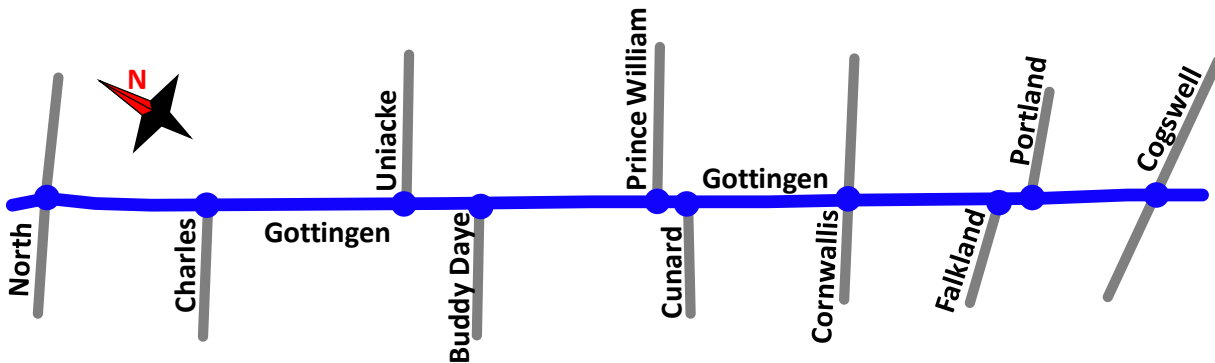

Figure 1: Gottingen Street Corridor

Table 1: Existing Conditions – Gottingen Street Corridor

<p>Vehicle Traffic</p>	<p>Key arterial street that provides a north-south connection between downtown Halifax and the bridge, as well as the north end and beyond</p> <p>Two lanes south of Uniacke Street</p> <p>Three lanes (2 northbound, 1 southbound) between Uniacke Street and North Street</p>
<p>Pedestrians / Cyclists</p>	<p><i>Walking:</i> An urban street with a diverse mixture of land uses, Gottingen Street is a busy pedestrian area. There are sidewalks on both sides of the street, though sidewalk width and separation from traffic lanes are limited by the narrow available right-of-way.</p> <p><i>Cycling:</i> Gottingen Street does not have any current or planned bicycle facilities. With a relatively narrow cross section and extensive transit service, it is not considered an ideal cycling route.</p>
<p>Transit</p>	<p>The Gottingen Street Corridor is served by the following routes at peak: 1, 7, 10, 11, 21, 31, 33, 34, 41, 53, 59, 61, 68, 86, 159, 320, 330, and 370. This is a total of approximately 79 trips at in the peak hour.</p> <p>The biggest impediment to bus operation on Gottingen Street is interaction with vehicles parked or stopped along the curb, which requires buses to awkwardly manoeuvre to get by them. The narrow curb-to-curb width exacerbates the challenges, often disrupting the flow of traffic in both directions.</p>
<p>Property Ownership</p>	<p>Available right-of-way along Gottingen Street is very limited. The typical curb-to-curb width is 10m, and building setbacks on both sides are typically very tight. It is not expected that property acquisition for the purposes of widening to expand the street is a viable approach.</p>
<p>Adjacent Land Uses</p>	<p>Diverse mix of residential and commercial</p>
<p>Parking and Loading</p>	<p>There are approximately 51 on-street parking spaces on Gottingen Street between Cogswell Street and Uniacke Street, all of which are time-limited (peak period, peak direction parking is restricted).</p> <p>Loading activities are completed from the existing parking spaces, in addition to one designated loading zone and any other locations not designated as 'No Stopping'.</p>

The design options presented in Table 2, which represent varying levels of investment, were developed for Gottingen Street. Functional design drawings, along with an overview of the implications (transit improvements and impacts to traffic, parking, and adjacent land uses), advantages, and disadvantages for the options for each section are provided on Pages 5 to 7, Attachment C.

Table 2: Design Options – Gottingen Street Corridor

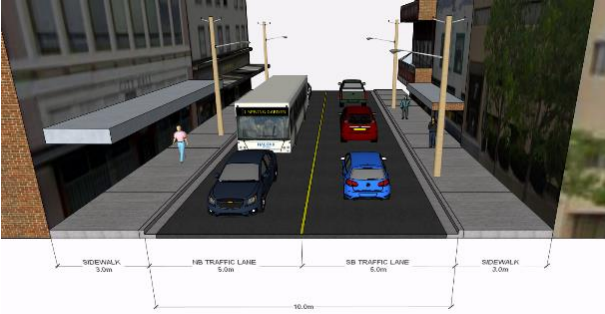
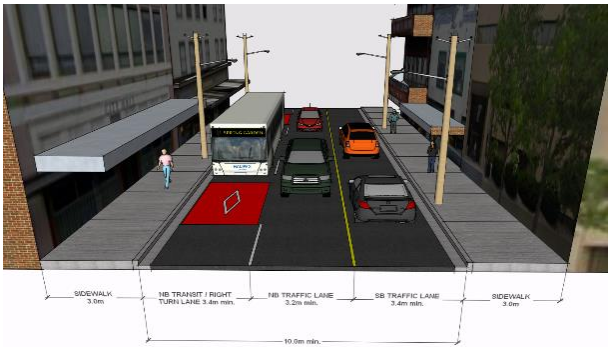
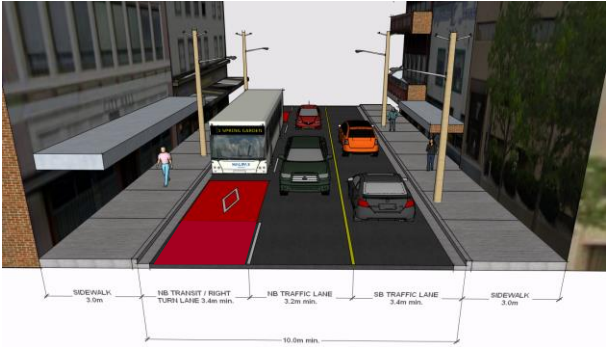
	Description	Summary of Impacts
<p>Low Investment: Peak Period Parking / Stopping Restrictions</p>	 <ul style="list-style-type: none"> No explicit transit priority measures Parking and stopping restricted on both sides of the street during AM and PM peak periods 	<ul style="list-style-type: none"> Transit Service: Does not provide priority for buses over general traffic, though transit delays may improve due to improvements to general traffic flow Walking: No impact. Bicycling: Minimal impact. Fewer conflicts with parked vehicles. Traffic Impacts: Improved traffic flow during AM and PM peak periods. Property Impacts: No impact. Parking / Loading: Removal of all on-street parking and loading on Gottingen Street during peak periods only.
<p>Medium Investment: Intermittent Outbound Transit Priority Measures</p>	 <ul style="list-style-type: none"> Installation of transit queue jump lanes at key locations; Installation of pedestrian half signals at key pedestrian crossings; 	<ul style="list-style-type: none"> Transit Service: Transit priority at key locations provide moderate service improvement. Walking: Minimal impact. The addition of signalized crosswalks improves street crossing experience. Bicycling: Minimal impact. Fewer conflicts with parked vehicles. Traffic Impacts: Improved traffic flow during AM and PM peak periods. Property Impacts: No impact. Parking / Loading: Removal of all on-street parking and loading on Gottingen Street during peak periods only.
<p>High Investment: Continuous Outbound Transit Priority Lane</p>	 <ul style="list-style-type: none"> Continuous outbound (northbound) lane for buses only (also permitted for use by right turning vehicles); Installation of pedestrian half signals at key pedestrian crossings; 	<ul style="list-style-type: none"> Transit Service: Continuous bus lane and transit priority lane provides significant service improvement. Walking: Minimal impact. The addition of signalized crosswalks improves street crossing experience. Bicycling: Minimal impact. Fewer conflicts with parked vehicles. Traffic Impacts: Improved traffic flow during AM and PM peak periods. Property Impacts: No impact. Parking / Loading: Full-time removal of all on-street parking and loading on Gottingen Street

Attachment B: Bayers Road Summary and Options Overview

Bayers Road

Due to the varying widths and conditions found along the Bayers Road corridor, for the purposes of this investigation it has been separated into the following three distinct sections (illustrated in Figure 1).

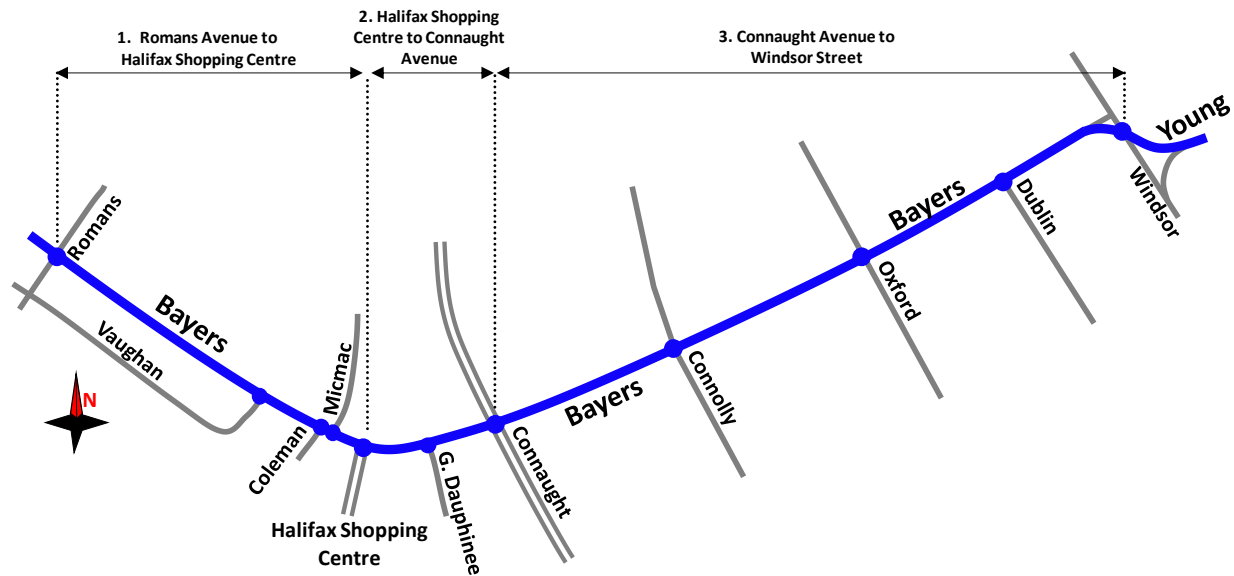

Figure 1: Bayers Road Corridor

Table 1 summarizes existing conditions for the three sections of Bayers Road related to vehicular traffic, active transportation, transit, property ownership, adjacent land uses, and parking / loading.

Table 1: Existing Conditions – Bayers Road Corridor

	Vehicle Traffic	Pedestrians / Cyclists	Transit	Property Ownership	Adjacent Land Uses	Parking and Loading
Romans Avenue to Halifax Shopping Centre	<p>Four lanes (2 lanes each direction) separated by a median</p> <p>Heavy traffic volumes and high delays during AM / PM peak periods</p>	<p><i>Walking:</i> Though there are existing sidewalks, it is not an ideal walking environment due to heavy traffic volumes and a lack of separation between the sidewalk and traffic lanes, which reduces comfort for pedestrians.</p> <p><i>Cycling:</i> Not currently an ideal cycling route due to heavy traffic volumes and lack of dedicated space for bicycles.</p>	<p>Used by routes 2, 17, 80, 81, 2, and 330</p> <p>Currently 20-25 buses (2-way) per hour in the PM peak</p>	<p>HRM owns majority of property on both sides of the street due to long-term corridor preservation efforts.</p>	<p>Residential</p>	<p>No existing designated on-street parking or loading areas</p>
Halifax Shopping Centre to Connaught Avenue	<p>5-6 lanes (including turn lanes to Halifax Shopping Centre)</p> <p>Short separation (approx. 100m) between Shopping Centre intersection and Connaught Avenue results in spillback of queues, causing congestion.</p> <p>Interaction of queues between intersections complicates access to local land uses including Halifax Shopping Centre.</p>	<p><i>Walking:</i> Existing sidewalks and separation from traffic provide good walking environment.</p> <p><i>Cycling:</i> Not currently an ideal cycling route due to heavy traffic volumes and lack of dedicated space for bicycles.</p>	<p>Used by routes 1, 29, 17, 80, 81, 2, and 330</p> <p>Currently 30-35 buses (2-way) per hour in the PM peak</p>	<p>HRM owns the parcel on the northwest corner of the Bayers Road – Connaught Avenue intersection</p>	<p>Primarily commercial</p>	
Connaught Avenue to Windsor Street	<p>Three lanes (2 westbound, 1 eastbound)</p> <p>Heavy traffic volumes and high delays during AM / PM peak periods</p>	<p><i>Walking:</i> Existing sidewalks and separation from traffic provide good walking environment.</p> <p><i>Cycling:</i> Not currently an ideal cycling route due to heavy traffic volumes and lack of dedicated space for bicycles.</p>	<p>Used by routes 1, 17, 80, 81, and 330</p> <p>Currently 25-30 buses (2-way) per hour in the PM peak</p>	<p>Private</p>	<p>Primarily residential with some commercial</p>	

The design options considered for the section of Bayers Road between Romans Avenue and the Halifax Shopping Centre are summarized in Table 2. Further detail and functional design sketches are provided on Page 1 (Attachment C).

Table 2: Design Options – Bayers Road (Romans Avenue to Halifax Shopping Centre)

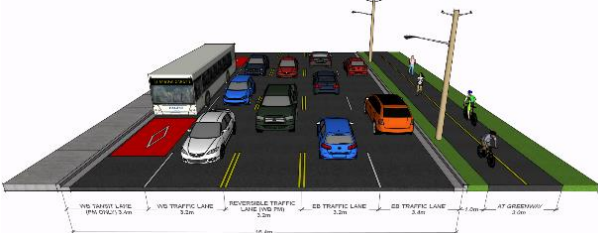
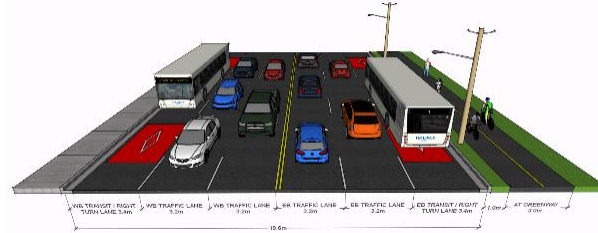
	Description	Summary of Impacts
<p>Medium Investment: Reversible Peak Direction Transit Lane</p>	 <ul style="list-style-type: none"> • Add a reversible dedicated bus lane (also permitted for use by right turning vehicles) that serves eastbound buses before noon and westbound buses after noon; • Requires reversible lane signage and pavement markings, similar to Chebucto Road. • Installation of a multi-use pathway on the south side of Bayers Road; 	<ul style="list-style-type: none"> • Transit Service: Significant transit improvement in the peak direction. Buses can bypass congestion, reducing delay and improving reliability. • Walking: Multi-use path provides increased separation between pedestrians and vehicular traffic. • Bicycling: Multi-use path provides high quality cycling connection, makes an important connection in AT Priorities Plan. • Traffic Impacts: Slight improvement to traffic flow due to removal of buses from general traffic. • Property Impacts: Requires the acquisition of a limited amount of property on the south side of Bayers Road. • Parking / Loading: No impact.
<p>High Investment: Continuous Eastbound and Westbound Transit Lanes</p>	 <ul style="list-style-type: none"> • Add continuous eastbound and westbound dedicated bus lanes (also permitted for use by right turning vehicles); • Installation of a multi-use pathway on the south side of Bayers Road; 	<ul style="list-style-type: none"> • Transit Service: Significant transit improvement in the both directions. Buses can bypass lengthy queues, reducing delay and improving reliability. • Walking: Multi-use path provides increased separation between pedestrians and vehicular traffic. • Bicycling: Multi-use path provides high quality cycling connection, makes an important connection in AT Priorities Plan. • Traffic Impacts: Slight improvement to traffic flow due to removal of buses from general traffic. • Property Impacts: Requires the acquisition of property on the south side of Bayers Road. Marginally more property is required that for the medium investment option. • Parking / Loading: No impact.



The design options considered for the section of Bayers Road between the Halifax Shopping Centre and Connaught Avenue are summarized in Table 3. Further detail and functional design sketches are provided on Page 2 (Attachment C).

Table 3: Design Options – Bayers Road (Halifax Shopping Centre to Connaught Avenue)

	Functional Sketch	Summary
<p>Low Investment: Dedicated Bus Lanes (Both Directions)</p>		<ul style="list-style-type: none"> • Eastbound and westbound dedicated bus lanes • Property acquisition required on south side of Bayers Road • Improves operation for through buses, but left turns to Halifax Shopping Centre remain a challenge. • Increasing roadway width extends pedestrian crossing distance
<p>Medium Investment: Reconfigured Shopping Centre Intersection with Dedicated Bus Lanes (Both Directions)</p>		<ul style="list-style-type: none"> • Add new one-way driveway connection to Shopping Centre across HRM-owned vacant parcel. • Eastbound and westbound dedicated bus lanes without need to widen Bayers Road. • Left turns into mall prohibited from Bayers Road, removing key source of congestion. New connection provides increased capacity for traffic entering Shopping Centre. • Less direct access for vehicles entering Shopping Centre.
<p>Medium Investment: Reconfigured Shopping Centre Intersection with Dedicated Bus Lanes (Both Directions)</p>		<ul style="list-style-type: none"> • Add new one-way driveway connection to Shopping Centre across HRM-owned vacant parcel <u>for buses only</u>. • Eastbound dedicated bus lane without need to widen Bayers Road. • Westbound buses can bypass congestion via new connection. Buses destined to Shopping Centre divert to new connection and proceed via transit signal phase. • Existing traffic access configuration for Shopping Centre is not impacted.
<p>High Investment: Grade Separated Crossing to Shopping Centre with Dedicated Bus Lanes (Both Directions)</p>		<ul style="list-style-type: none"> • Add new grade separated, two-way connection (bridge) to Shopping Centre across HRM-owned vacant parcel. • Remove signals from Shopping Centre intersections. Add signals to Connaught Avenue – Roslyn Road intersection. • Eastbound and westbound dedicated bus lanes without need to widen Bayers Road. • Less direct access for vehicles entering Shopping Centre, but higher capacity than existing.

The design options considered for the section of Bayers Road between Connaught Avenue and Windsor Street are summarized in Table 4. Further detail and functional design sketches are provided on Pages 3-4 (Attachment C).

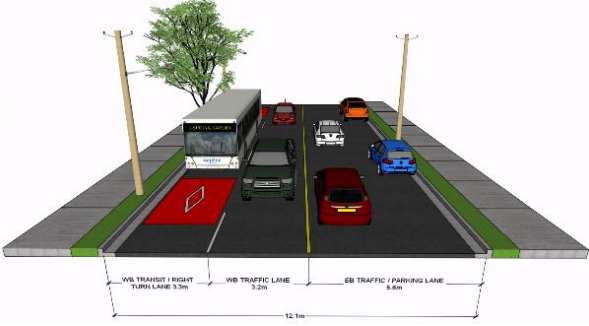
Table 4: Design Options – Bayers Road (Connaught Avenue to Windsor Street)

	Description	Summary of Impacts
<p>Low Investment: Westbound Transit Lane</p>	 <ul style="list-style-type: none"> • Continuous westbound dedicated bus lane (also permitted for use by right turning vehicles); 	<ul style="list-style-type: none"> • Transit Service: Significant transit improvement in the westbound direction. Buses can bypass lengthy queues, reducing delay and improving reliability. • Walking: No impact. • Bicycling: No impact. • Traffic Impacts: Loss of one westbound traffic lane; removal of buses from general westbound traffic flow • Property Impacts: No Impact. • Parking / Loading: Modified parking restrictions.
<p>Medium Investment: Reversible Peak Direction Transit Lane</p>	 <ul style="list-style-type: none"> • Reversible dedicated bus lane (also permitted for use by right turning vehicles) that serves eastbound buses before noon and westbound buses after noon; • Requires reversible lane signage and pavement markings, similar to Chebucto Road. 	<ul style="list-style-type: none"> • Transit Service: Significant transit improvement in the peak direction. Buses can bypass lengthy queues, reducing delay and improving reliability. • Walking: No impact. • Bicycling: No impact. • Traffic Impacts: Slight improvement to traffic flow in the peak direction due to removal of buses from general traffic. • Property Impacts: Requires minimal property acquisition, primarily on the south side of Bayers Road. • Parking / Loading: Loss of on-street parking between Connolly Street and Dublin Street.
<p>High Investment: Continuous Eastbound and Westbound Transit Lanes</p>	 <ul style="list-style-type: none"> • Continuous eastbound and westbound dedicated bus lanes (also permitted for use by right turning vehicles); 	<ul style="list-style-type: none"> • Transit Service: Significant transit improvement in the both directions. Buses can bypass lengthy queues, reducing delay and improving reliability. • Walking: No impact. • Bicycling: No impact. • Traffic Impacts: Slight improvement to traffic flow due to removal of buses from general traffic. • Property Impacts: Requires property acquisition, primarily on the south side of Bayers Road. • Parking / Loading: Loss of on-street parking between Connolly Street and Dublin Street.

BAYERS RD. - ROMANS AVE. TO HALIFAX SHOPPING CENTRE

OPTION 1 - HIGH INVESTMENT: DEDICATED BUS LANES (BOTH DIRECTIONS)



	Significant improvements to the flow of public transit.
	No major impacts. Slight improvement to traffic flow expected.
	New 3m off-street AT greenway.
	No impact.
	Impacts to properties along the corridor due to required road widening.

IMPACTS

PROS

- Will significantly improve transit movement in both directions at all times.
- Improves right-turn movement Bayers to Romans.
- Provides new AT greenway.

CONS

- Requires roadway expansion.
- Impacts residential properties along the corridor.

OPTION 2 - MEDIUM INVESTMENT: PEAK DIRECTION 'REVERSIBLE' BUS LANES

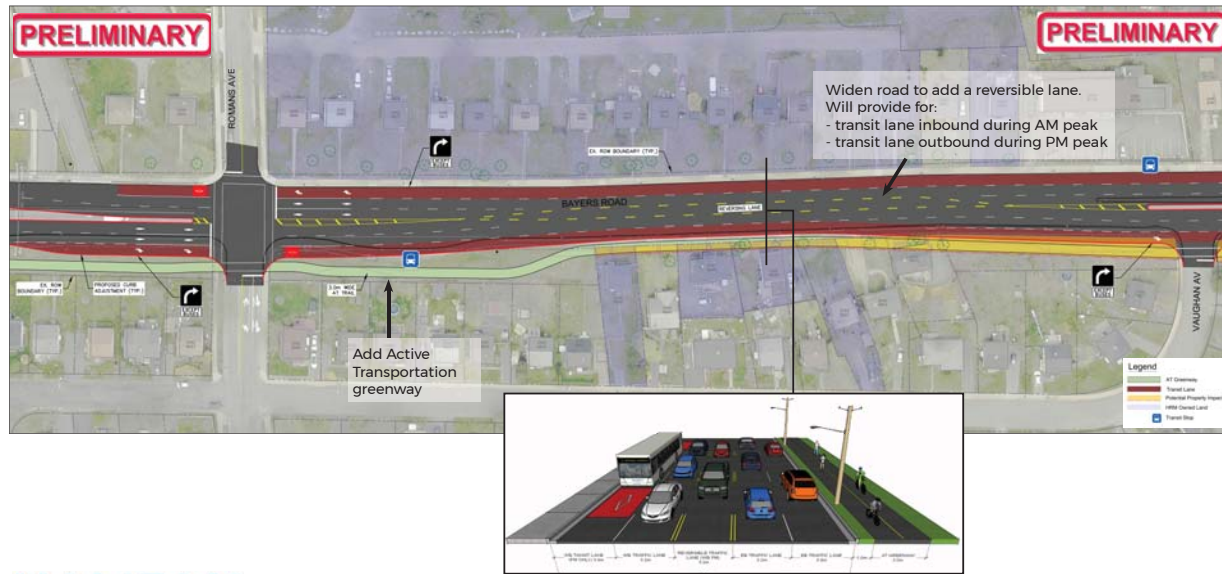

	Improvement to the flow of public transit.
	No major impacts. Slight improvement expected.
	New 3m off-street AT greenway.
	No impact.
	Impacts to properties along the corridor, but to a lesser extent than Option A (due to a reduced widening requirement).

IMPACTS

PROS

- Will improve transit movement in peak direction only.
- Improves right-turn movement Bayers to Romans.
- Provides new AT greenway.
- Lower impacts on adjacent residential properties along the corridor.

CONS

- Requires roadway expansion.
- Only prioritizes transit one way (peak direction).

BAYERS RD. - HALIFAX SHOPPING CENTRE TO CONNAUGHT AVE.

OPTION 1 - HIGH INVESTMENT: MODIFIED HALIFAX SHOPPING CENTRE DRIVEWAY (WITH BRIDGE) AND DEDICATED BUS LANES (BOTH DIRECTIONS)

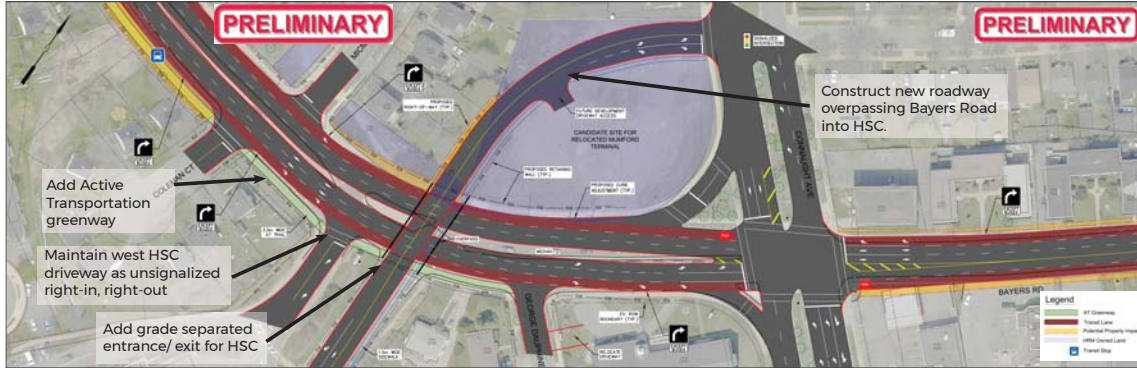

IMPACTS



- Significant improvements to the flow of public transit.
- Significant improvement of traffic flow with removal of HSC signals.
- New 3m off-street AT greenway. Grade separated crossing of Bayers Road.
- No impact.
- Properties will be impacted to allow for roadway adjustments.

PROS

- Will significantly improve transit movement via transit lanes.
- Reduces merging conflicts into Halifax Shopping Centre.
- Alleviates queuing impacts by removing signal at HSC.
- Provides new Active Transportation greenway.

CONS

- High level of investment (cost).
- High level of impact to adjacent properties.
- Prolonged disruption during construction.

OPTION 2 - MEDIUM INVESTMENT: MODIFIED HALIFAX SHOPPING CENTRE DRIVEWAY (REALIGNED INTERSECTION) AND DEDICATED BUS LANES (BOTH DIRECTIONS)

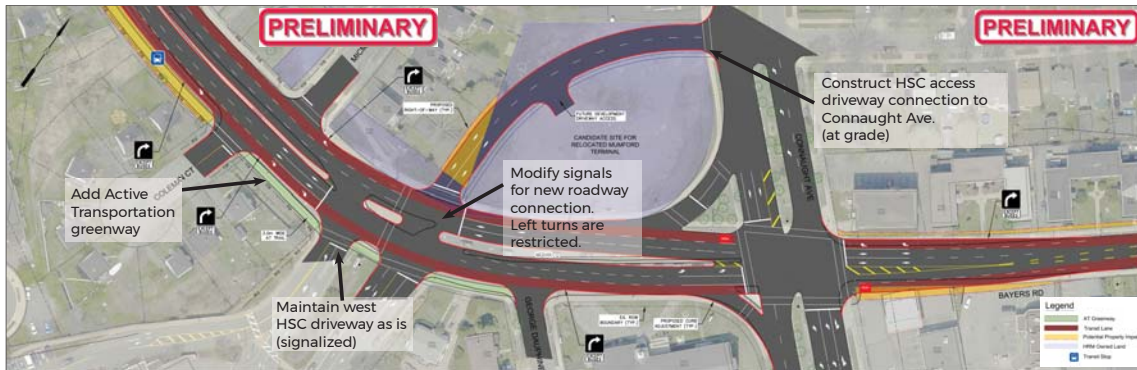

IMPACTS



- Significant improvements to the flow of public transit.
- Improvement of traffic flow with intersection re-alignment.
- New 3m off-street AT greenway.
- No impact.
- Properties will be impacted to allow for roadway adjustments.

PROS

- Will significantly improve transit movement via transit lanes.
- Reduces merging conflicts into HSC.
- Eases through-moving traffic between Connaught and HSC.
- Provides new AT greenway.

CONS

- Maintains close signal spacing along Bayers Road.
- Moderate level of impact to adjacent properties.

OPTION 3 - LOW INVESTMENT: DEDICATED BUS LANES (BOTH DIRECTIONS)

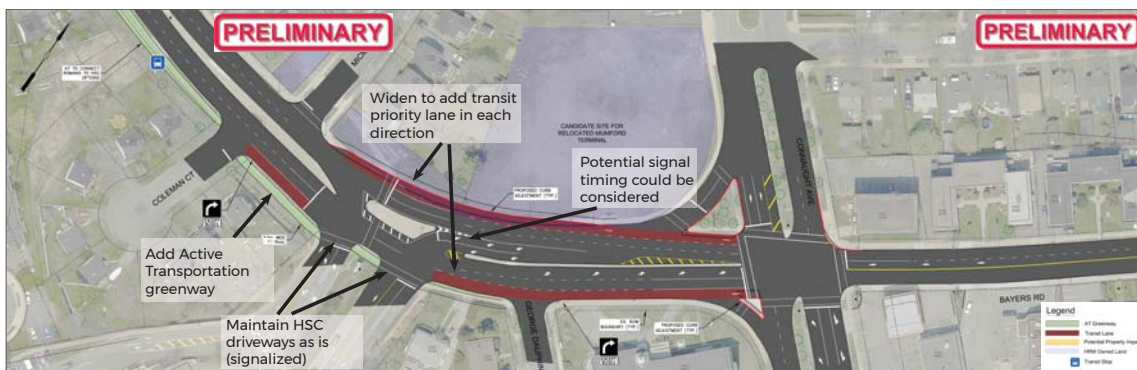

IMPACTS



- Moderate improvements to the flow of public transit.
- No major impacts to traffic flow. Slight improvement expected.
- New 3m off-street AT greenway.
- No impact.
- Slight impacts to properties with AT trail.

PROS

- Will move public transit more effectively than what is currently in place.
- Provides new AT greenway.
- Reduced impacts to adjacent properties.

CONS

- Does not improve transit operations at Connaught Ave. in the outbound direction.
- Will not address queuing and merging issues caused by closely spaced intersections.

BAYERS RD. - CONNAUGHT AVE. TO OXFORD ST.

OPTION 1 - HIGH INVESTMENT: DEDICATED BUS LANES (BOTH DIRECTIONS)

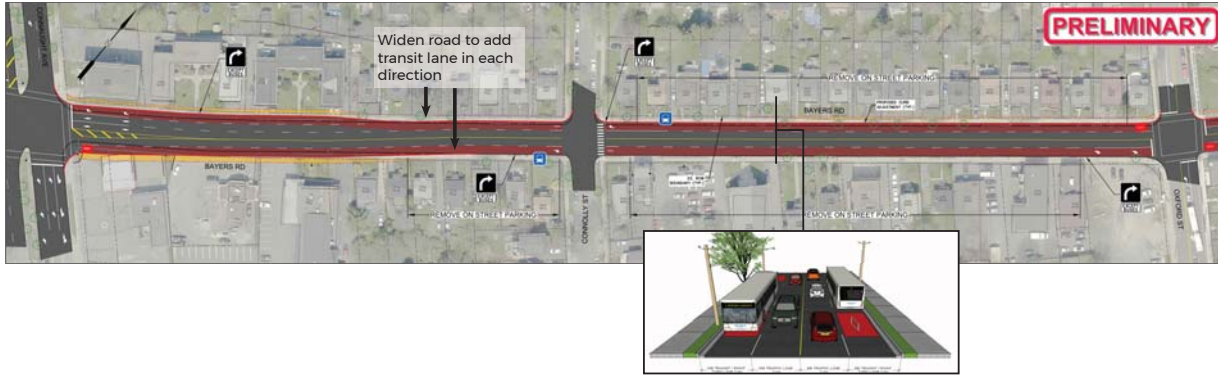

IMPACTS	
Bus	Significant improvements to the flow of public transit inbound and outbound.
Car	Fewer outbound lanes available.
Ped/Bike	No impact.
Parking	Removal of on-street parking.
House	Slight road widening may impact properties along the corridor.

PROS	
•	Will significantly improve transit movement, particularly during PM peak periods.
CONS	
•	Fewer travel lanes for through-moving vehicles on Bayers Road.
•	Road widening is required and may impact properties along the corridor.
•	Removal of on-street parking

OPTION 2 - MEDIUM INVESTMENT: PEAK DIRECTION 'REVERSIBLE' BUS LANES



IMPACTS	
Bus	Improvements to the flow of public transit during peak periods.
Car	Fewer outbound lanes available.
Ped/Bike	No impact
Parking	Removal of on-street parking.
House	No major impacts

PROS	
•	Will improve transit movement in peak directions.
•	Significantly less road widening required (reduction in property impacts).
CONS	
•	Does not benefit transit in off-peak direction.
•	Fewer travel lanes for through-moving vehicles on Bayers Road.
•	Removal of on-street parking

OPTION 3 - LOW INVESTMENT: WESTBOUND (OUTBOUND) DEDICATED BUS LANE



IMPACTS	
Bus	Minimally improves flow of public transit.
Car	Fewer outbound lanes available.
Ped/Bike	No impact
Parking	Modified parking restrictions.
House	No major impact

PROS	
•	No impact to on-street parking and adjacent properties.
CONS	
•	Minimal improvement for public transit relative to existing conditions.
•	Challenges for traffic congestion remain.
•	Potential parking loss.

BAYERS RD. - OXFORD ST. TO WINDSOR ST.

OPTION 1 - HIGH INVESTMENT: DEDICATED BUS LANES (BOTH DIRECTIONS)

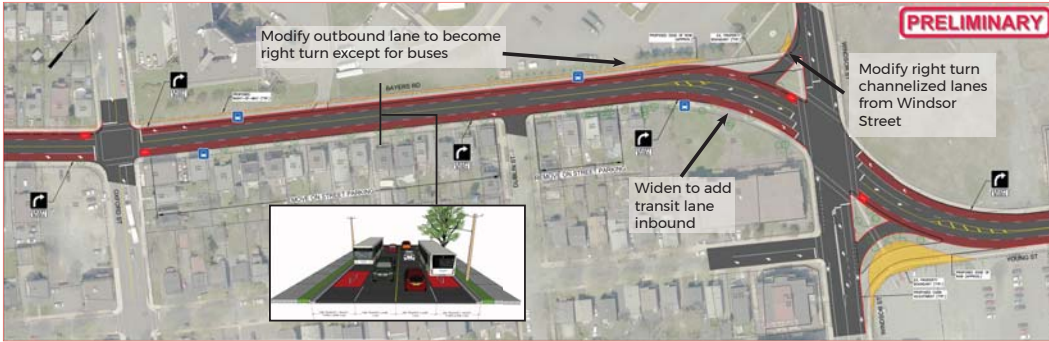

IMPACTS

Significant improvements to the flow of public transit inbound and outbound.
Fewer outbound lanes available for the corridor segment (Windsor to Oxford).
No impact
Reduced time available for on street parking.
Slight road widening may impact properties along the corridor.

PROS

- Will significantly improve transit movement, particularly during PM peak periods.
- Improve right-turn movement from Bayers Rd. to Oxford St. and Bayers Rd. to Windsor St.
- Improves visibility of right-turns at Windsor/ Bayers/ Young intersection.
- More land available at Windsor/Bayers/ Young intersection for streetscaping.

CONS

- Road widening is required and may impact properties along the corridor.
- Fewer travel lanes for through-moving vehicles on Bayers Rd.
- Reduced time available for on-street parking.

OPTION 2 - MEDIUM INVESTMENT: PEAK DIRECTION 'REVERSIBLE' BUS LANES

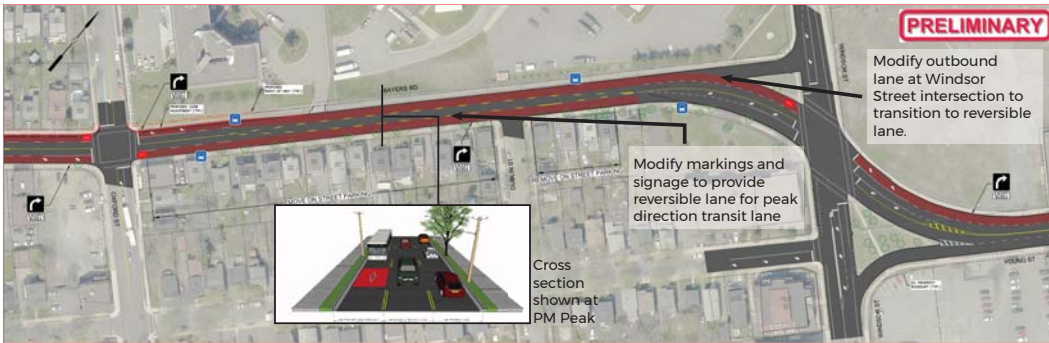

IMPACTS

Improvements to the flow of public transit during peak periods.
Fewer outbound lanes available for the corridor segment (Windsor to Oxford).
No impact
Reduced time available for on street parking.
No major impacts

PROS

- Will significantly improve transit movement, particularly during PM peak periods.
- Improve right-turn movement from Bayers to Oxford during PM peak.
- Significantly less road widening required (reduction in property impacts).

CONS

- Will reduce benefit to transit in off-peak direction.
- Fewer travel lanes for through-moving vehicles on Bayers Road.
- Reduced time available for on street parking.

OPTION 3 - LOW INVESTMENT: WESTBOUND (OUTBOUND) DEDICATED BUS LANE



IMPACTS

Minimally improves flow of public transit.
Fewer outbound lanes available for the corridor segment (Windsor to Oxford).
No impact
Modified parking restrictions.
No impact

PROS

- Will improve transit movement in outbound direction, particularly during PM peak periods.
- Improve right-turn movement from Bayers to Oxford during PM peak.
- No road widening required.
- No on street parking impacts.

CONS

- Minimal improvement for public transit relative to existing conditions.
- Fewer travel lanes for through-moving vehicles on Bayers Road.
- Potential parking loss.

GOTTINGEN ST. - CORNWALLIS ST. TO COGSWELL ST.

OPTION 1 - HIGH INVESTMENT: CONTINUOUS OUTBOUND (NORTHBOUND) TRANSIT PRIORITY LANE

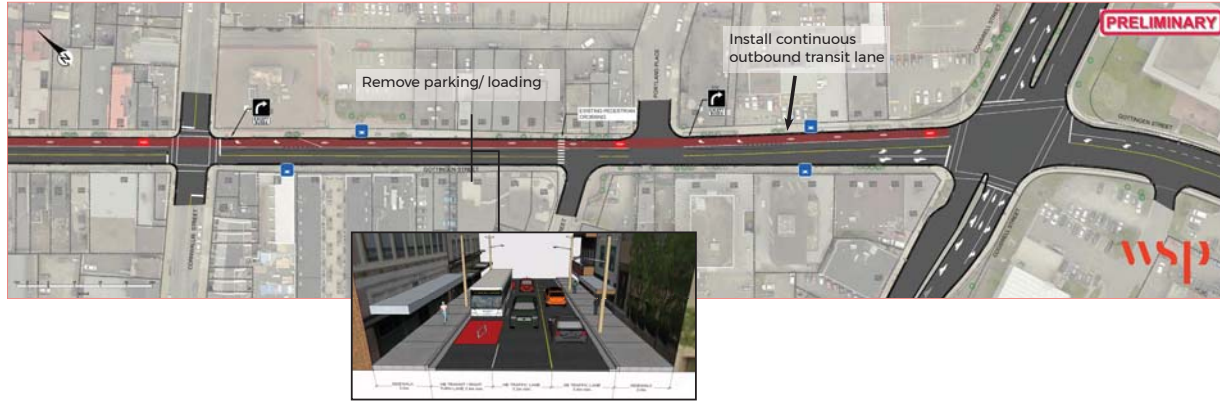

IMPACTS



Improvements to the flow of transit in the outbound (northbound) direction.

Slightly improved traffic flow.

Reduced conflicts with parked vehicles.

No impact.

Full-time loss of parking / loading. Anticipated relocation of some parking / loading to nearby streets.

PROS

- Continuous improvement to transit flow in outbound (northbound) direction.
- Improvement to transit schedule reliability in outbound (northbound) direction.
- High visibility transit priority.
- Potential to increase compliance of parking and loading restrictions.
- Some improvement to the flow of traffic during peak periods.

CONS

- Full-time loss of parking / loading

OPTION 2 - MEDIUM INVESTMENT: INTERMITTENT OUTBOUND (NORTHBOUND) TRANSIT PRIORITY MEASURES

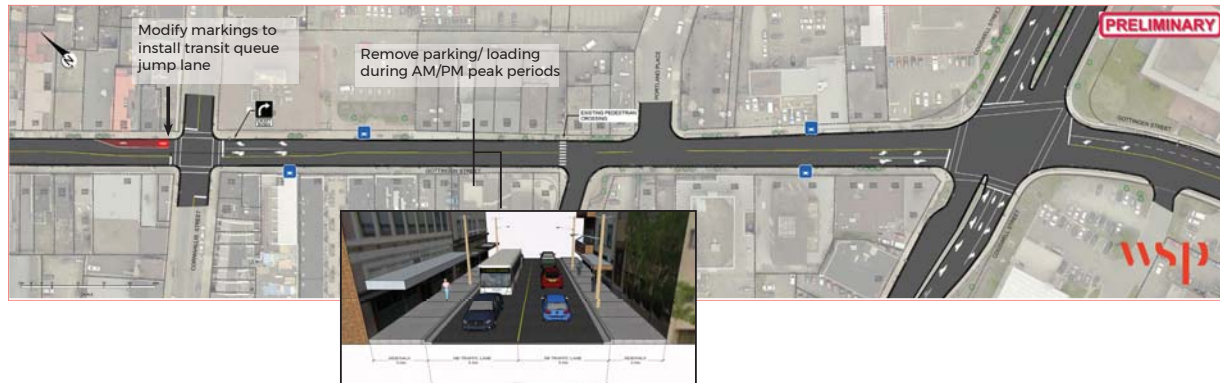

IMPACTS



Slight improvement to the flow of transit in outbound direction.

Slightly improved traffic flow during peak periods.

Reduced conflicts with parked vehicles.

No impact

Loss of parking/loading during peak periods. Anticipated relocation of some parking / loading to nearby streets.

PROS

- Slight improvement to traffic and transit flow during peak periods.
- Some improvement to transit schedule reliability.
- Easy to implement, low cost.

CONS

- Not expected to provide the desired level of transit priority on this busy transit corridor.
- Loss of parking / loading during peak periods.

OPTION 3 - LOW INVESTMENT: PEAK PERIOD PARKING / LOADING / STOPPING RESTRICTIONS



IMPACTS



Slight improvement to the flow of transit during peak periods.

Slightly improved traffic flow during peak periods

Reduced conflicts with parked vehicles.

No impact

Loss of parking/loading during peak periods. Anticipated relocation of some parking / loading to nearby streets.

PROS

- Slight improvement to traffic and transit flow during peak periods.
- Slight improvement to transit schedule reliability during peak periods.
- Easy to implement, low cost.

CONS

- Does not prioritize transit.
- Loss of parking / loading during peak periods.

GOTTINGEN ST. - UNIACKE ST. TO CORNWALLIS ST.

OPTION 1 - HIGH INVESTMENT: CONTINUOUS OUTBOUND (NORTHBOUND) TRANSIT PRIORITY LANE

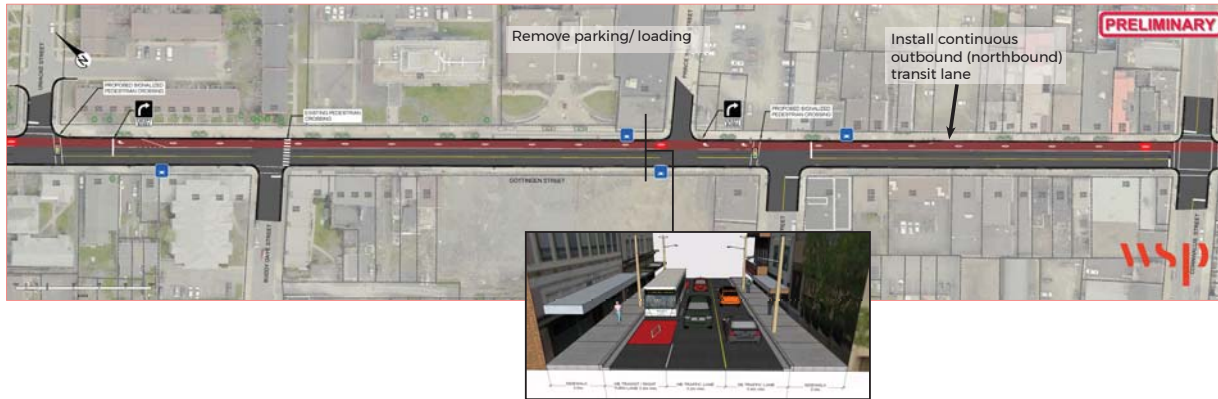

IMPACTS



- Improvements to the flow of transit in the outbound (northbound) direction.
- Slightly improved traffic flow.
- Reduced conflict with parked vehicles.
- Added signalized crossings of Gottingen St. at Cunard St. and Uniacke St.
- Full-time loss of parking / loading. Anticipated relocation of some parking / loading to nearby streets.

PROS

- Continuous improvement to transit flow in outbound (northbound) direction.
- Improvement to transit schedule reliability in outbound direction.
- High visibility transit priority.
- Potential to increase compliance of parking and loading restrictions.
- Signalized crosswalk will provide a higher visible crossing for pedestrians.
- Some improvement to the flow of traffic during peak periods.

CONS

- Full-time Loss of parking / loading

OPTION 2 - MEDIUM INVESTMENT: INTERMITTENT OUTBOUND (NORTHBOUND) TRANSIT PRIORITY MEASURES

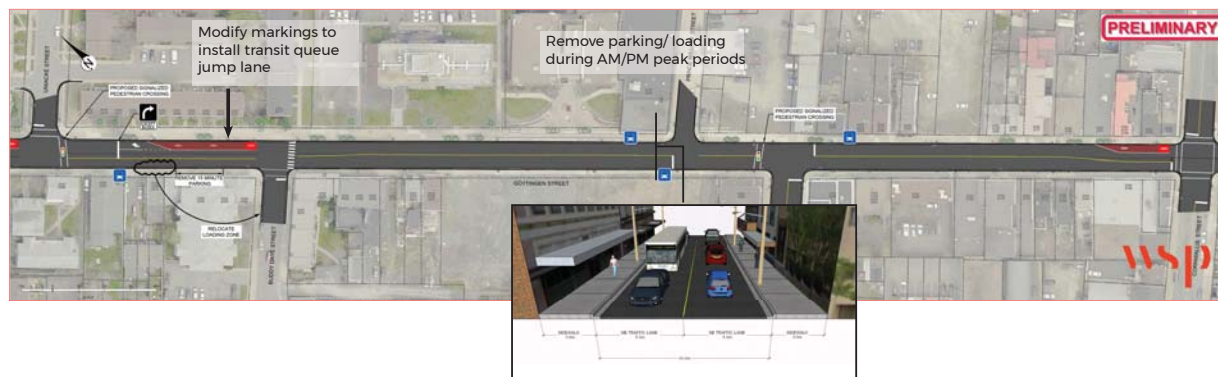

IMPACTS



- Slight improvement to the flow of transit in outbound direction.
- Slightly improved traffic flow during peak periods.
- Reduced conflict with parked vehicles.
- No impact
- Loss of parking/loading during peak periods. Anticipated relocation of some parking / loading to nearby streets.

PROS

- Slight improvement to traffic and transit flow during peak periods.
- Some improvement to transit schedule reliability.
- Easy to implement, low cost.

CONS

- Not expected to provide the desired level of transit priority on this busy transit corridor.
- Loss of parking / loading during peak periods.

OPTION 3 - LOW INVESTMENT: PEAK PERIOD PARKING / LOADING / STOPPING RESTRICTIONS

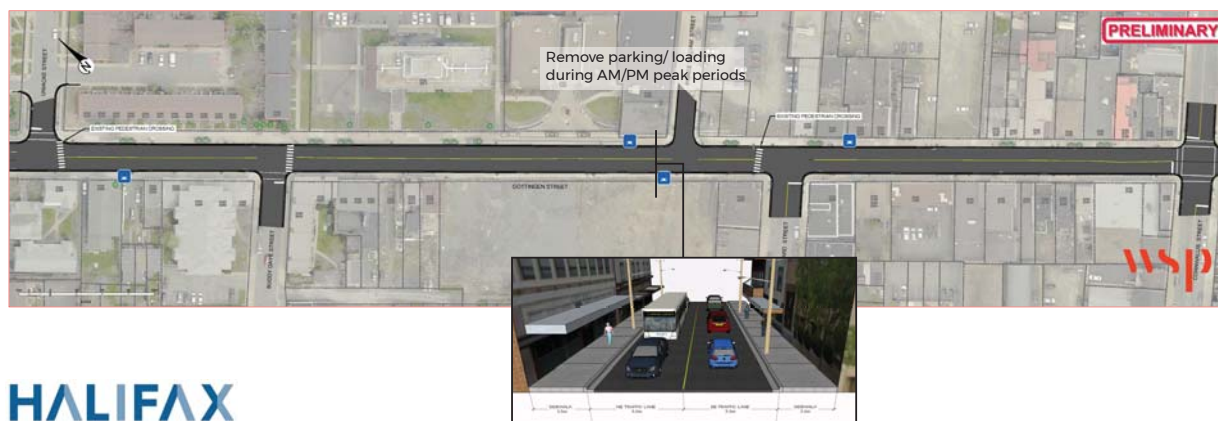

IMPACTS



- Slight improvement to the flow of transit during peak periods.
- Slightly improved traffic flow.
- Reduced conflicts with parked vehicles.
- No impact
- Loss of parking/loading during peak periods. Anticipated relocation of some parking / loading to nearby streets.

PROS

- Slight improvement to traffic and transit flow during peak periods.
- Slight improvement to transit schedule reliability during peak periods.
- Easy to implement, low cost.

CONS

- Does not prioritize transit
- Loss of parking / loading during peak periods

GOTTINGEN ST. - NORTH ST. TO UNIACKE ST.

OPTION 1 - HIGH INVESTMENT: CONTINUOUS OUTBOUND (NORTHBOUND) TRANSIT PRIORITY LANE



IMPACTS	
	Improvements to the flow of transit in the outbound (northbound) direction.
	Impacts right-turn movement toward Macdonald Bridge.
	Reduced conflict with parked vehicles.
	Added signalized crossings of Gottingen St. at Uniacke St.
	Full-time loss of parking / loading. Anticipated relocation of some parking / loading to nearby streets.

- PROS**
- Continuous improvement to transit flow in outbound (northbound) direction.
 - Improvement to transit schedule reliability in outbound direction.
 - High visibility transit priority.
 - Signalized crosswalk will provide a higher visible crossing for pedestrians.
- CONS**
- Full-time Loss of loading.

OPTION 2 - MEDIUM INVESTMENT: INTERMITTENT OUTBOUND (NORTHBOUND) TRANSIT PRIORITY MEASURES



IMPACTS	
	Slight improvement to the flow of transit in outbound (northbound) directions.
	Impacts right-turn movement toward Macdonald Bridge.
	No impact.
	Added signalized crossings of Gottingen St. at Uniacke St.
	No parking on section modified to no stopping during peak periods.

- PROS**
- Slight improvement to traffic and transit flow during peak periods.
 - Some improvement to transit schedule reliability.
 - Easy to implement, low cost
 - Signalized crosswalk will provide a higher visible crossing for pedestrians.
- CONS**
- Not expected to provide the desired level of transit priority on this busy transit corridor.
 - Loss of loading during peak periods.

OPTION 3 - LOW INVESTMENT: PEAK PERIOD PARKING / LOADING / STOPPING RESTRICTIONS



IMPACTS	
	No major impact to this section of Gottingen Street.
	No major impact.
	No impact.
	No impact.
	No parking on section modified to no stopping during peak periods.

- PROS**
- Easy to implement, low cost.
- CONS**
- Does not prioritize transit.
 - Loss of loading during peak periods.

HALIFAX

**Bayers Road /
Gottingen Street
Transit Priority
Corridors**

Public Feedback Survey Summary

October-19-17

Bayers Road

Shape Your City Online Survey	469
Paper Survey	19
Total Participants	488

Bayers Road

How often do you use Bayers Road?

of Responses

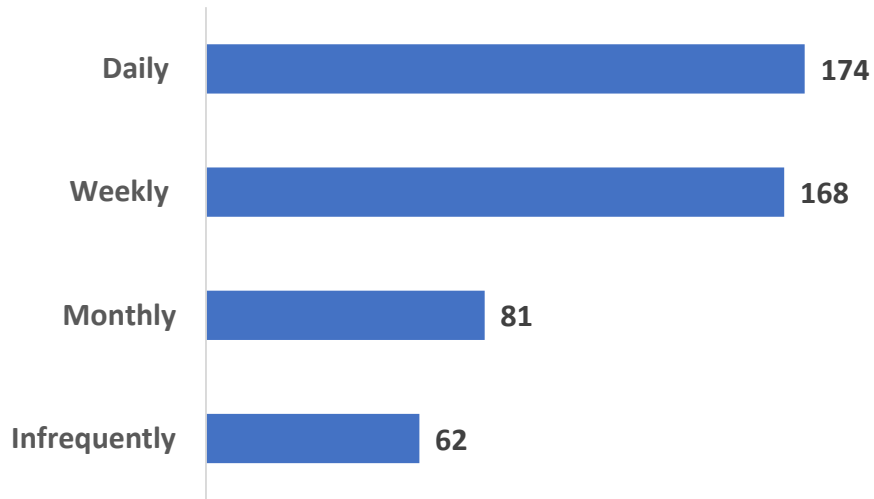

How do you usually travel on Bayers Road?

of Responses

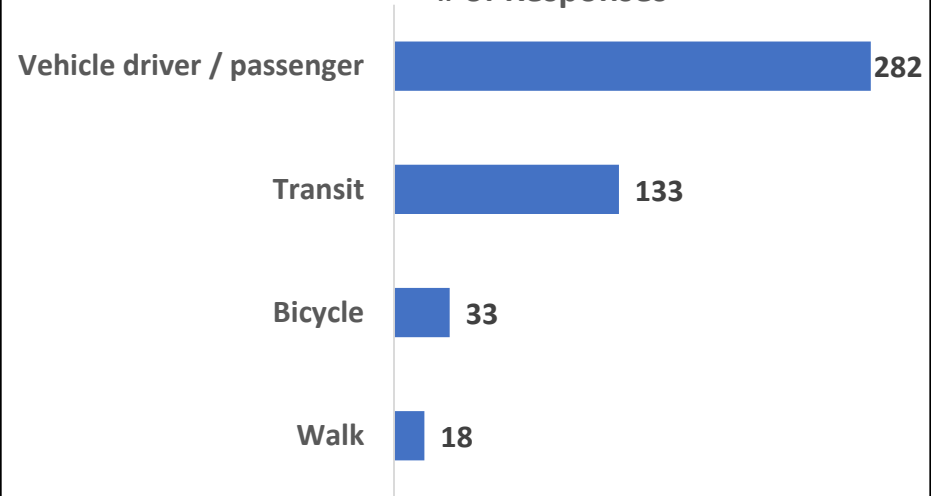

Bayers Road

What matters most to you when you use Bayers Road? (select up to 3)

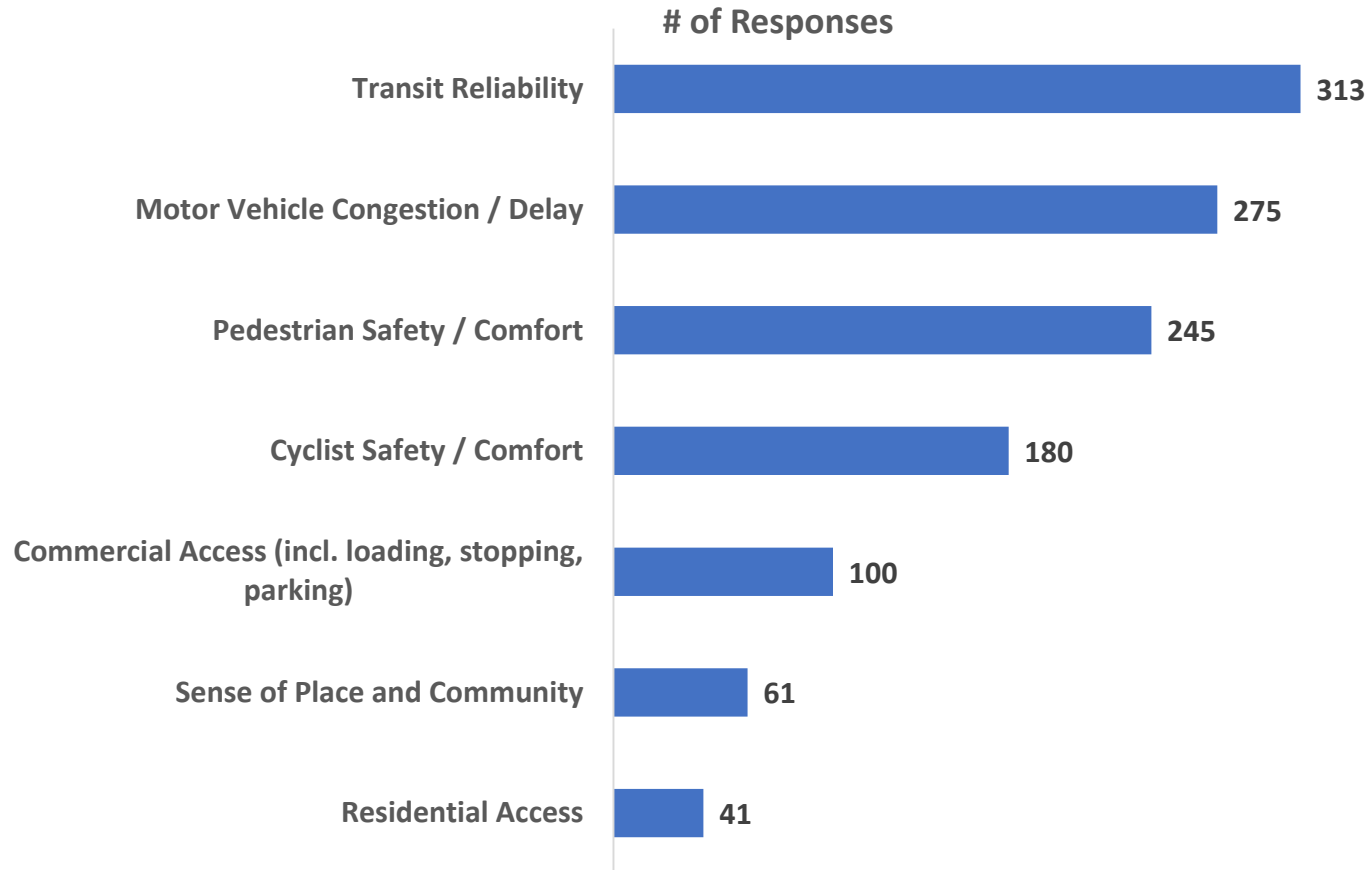

Bayers Road

On a scale from 1-4 (where 1 is poor and four is excellent) how would you rate your experiences on Bayers Road?

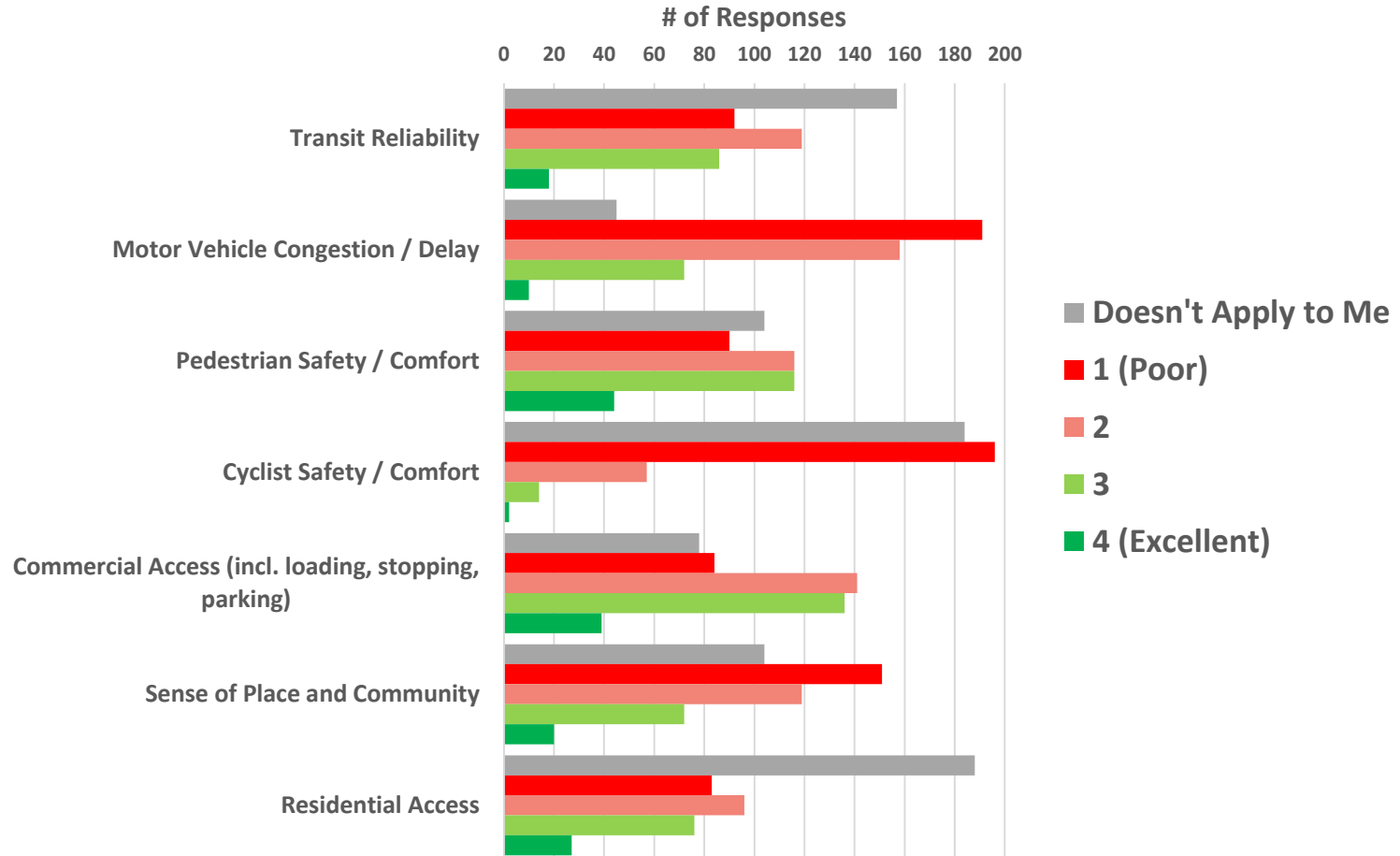

Bayers Road

The addition of transit priority lanes on Bayers Road may require trade-offs in some locations. How acceptable are the following potential trade-offs?

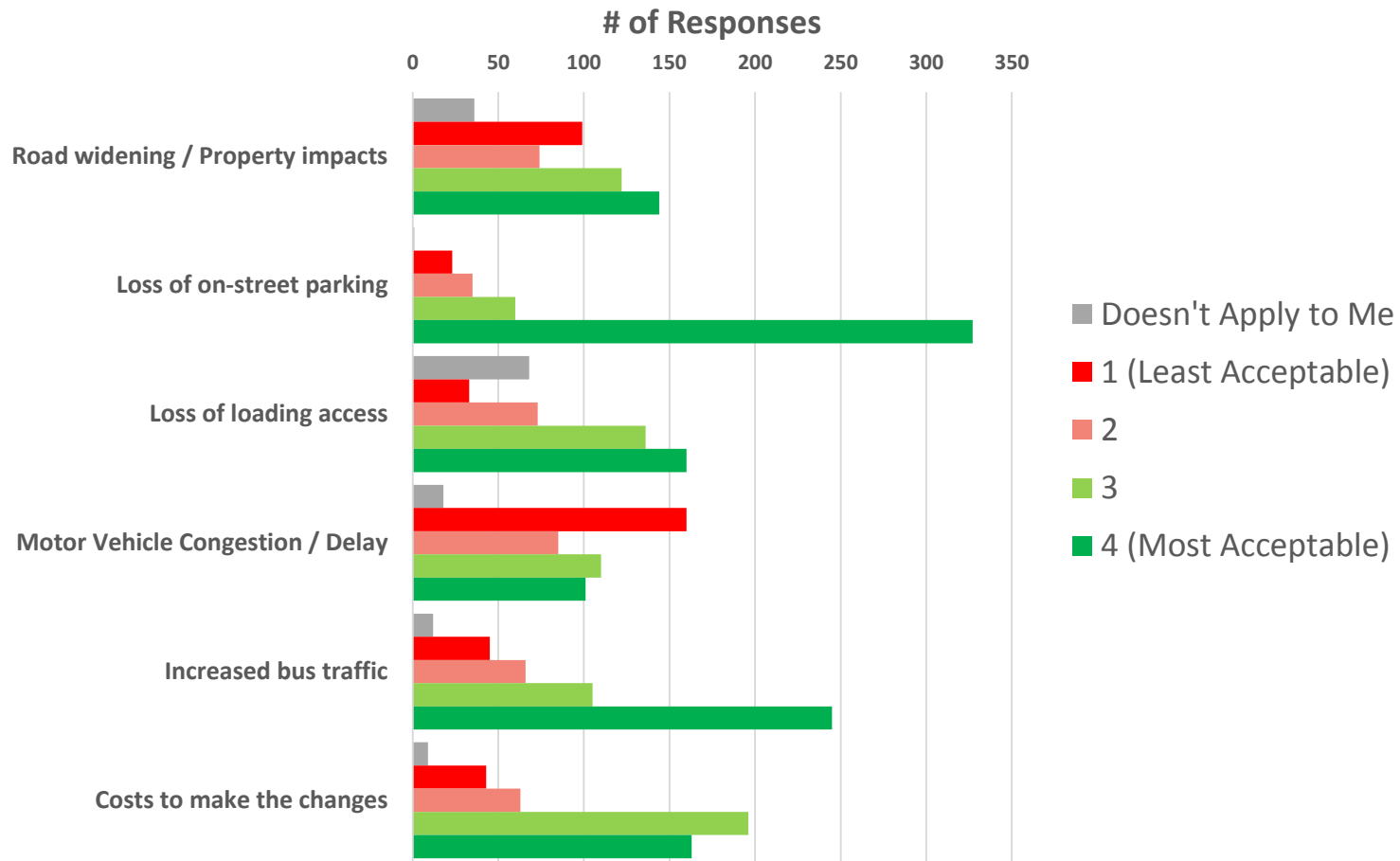

Bayers Road

Section 1 (Romans Ave. to Halifax Shopping Centre):
Indicate your preference based on the presented concepts

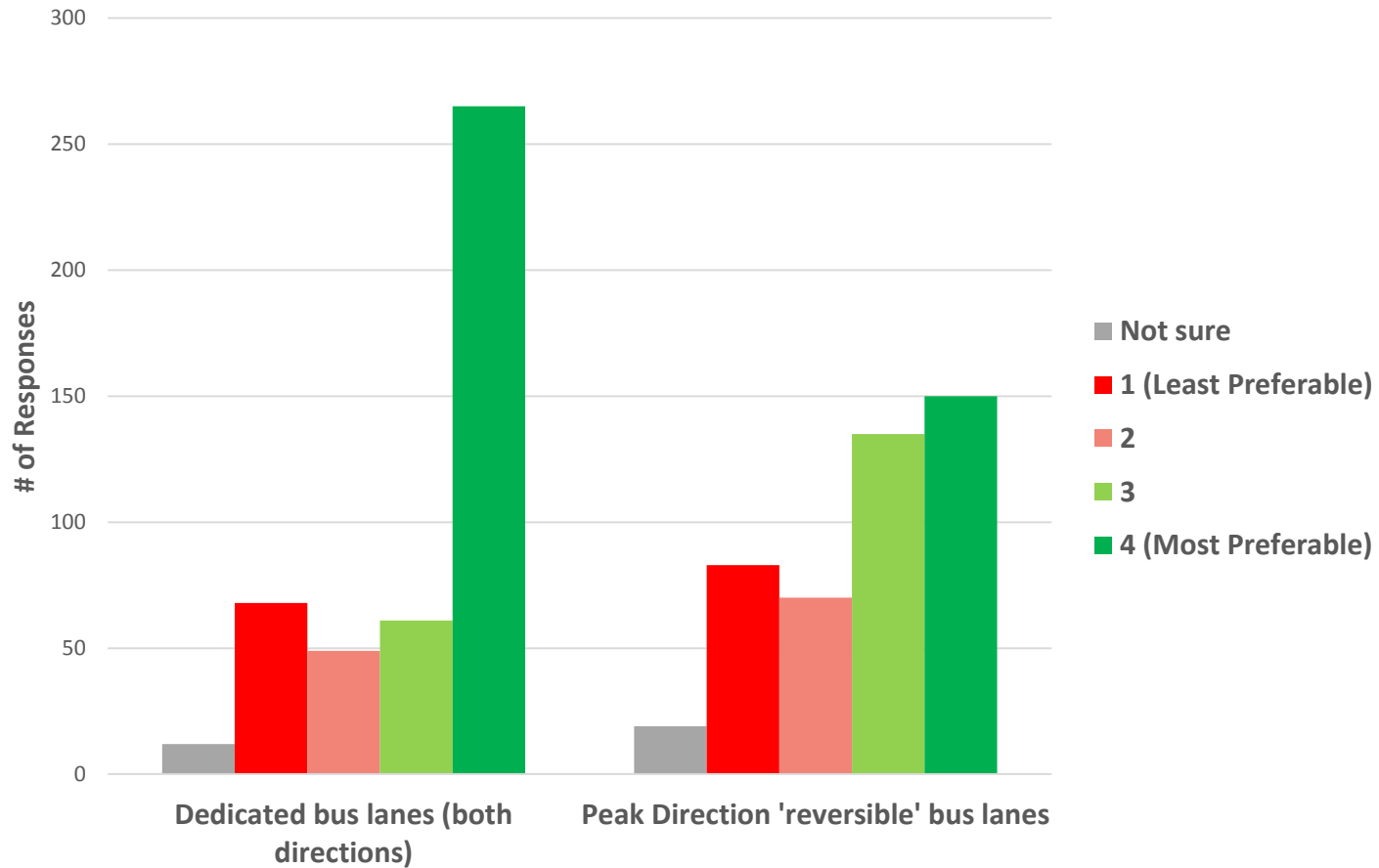

Bayers Road

Section 2 (Halifax Shopping Centre to Connaught Ave.):
Indicate your preference based on the presented concepts

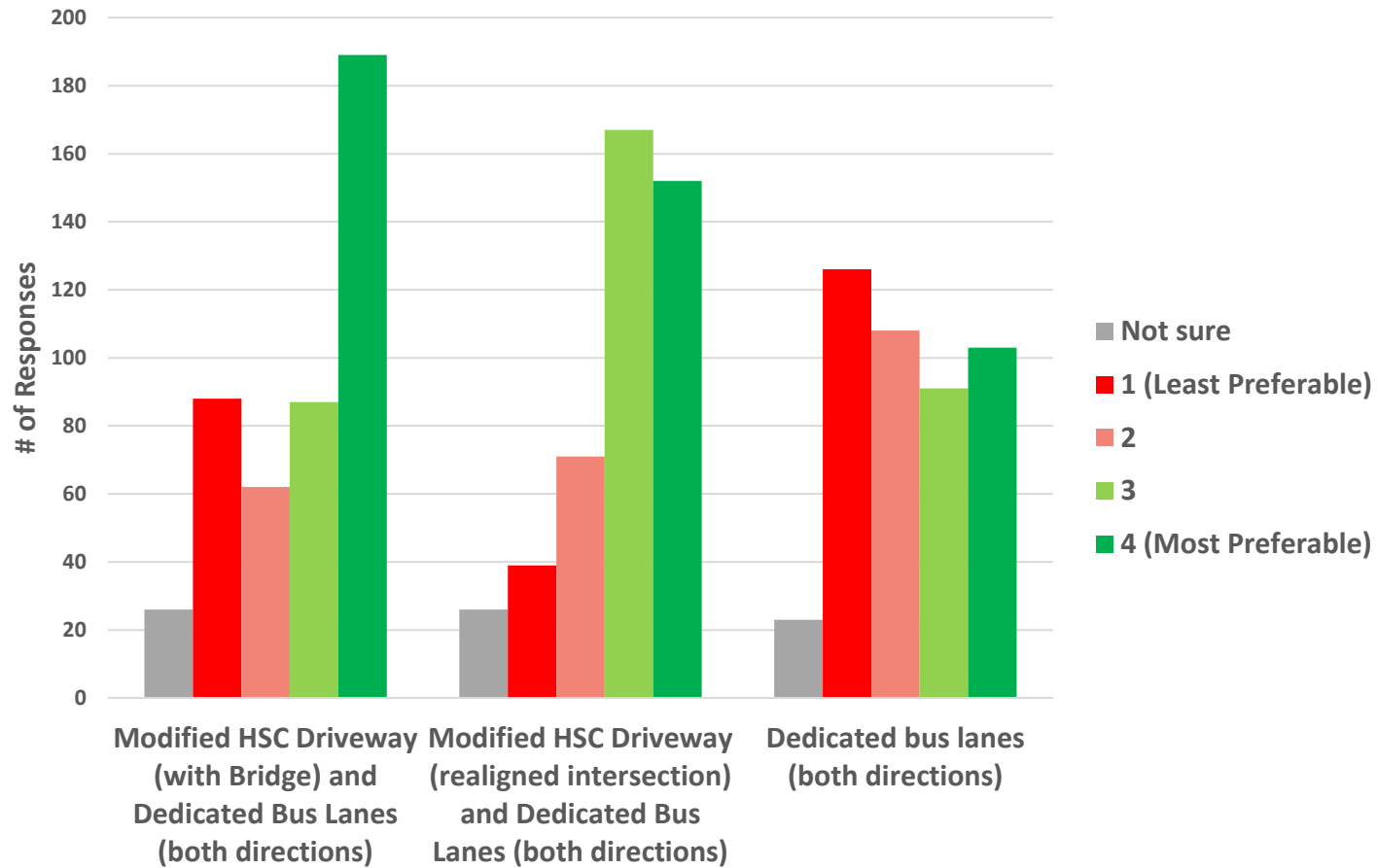

Bayers Road

Section 3 (Connaught Ave. to Connolly Street):
Indicate your preference based on the presented concepts

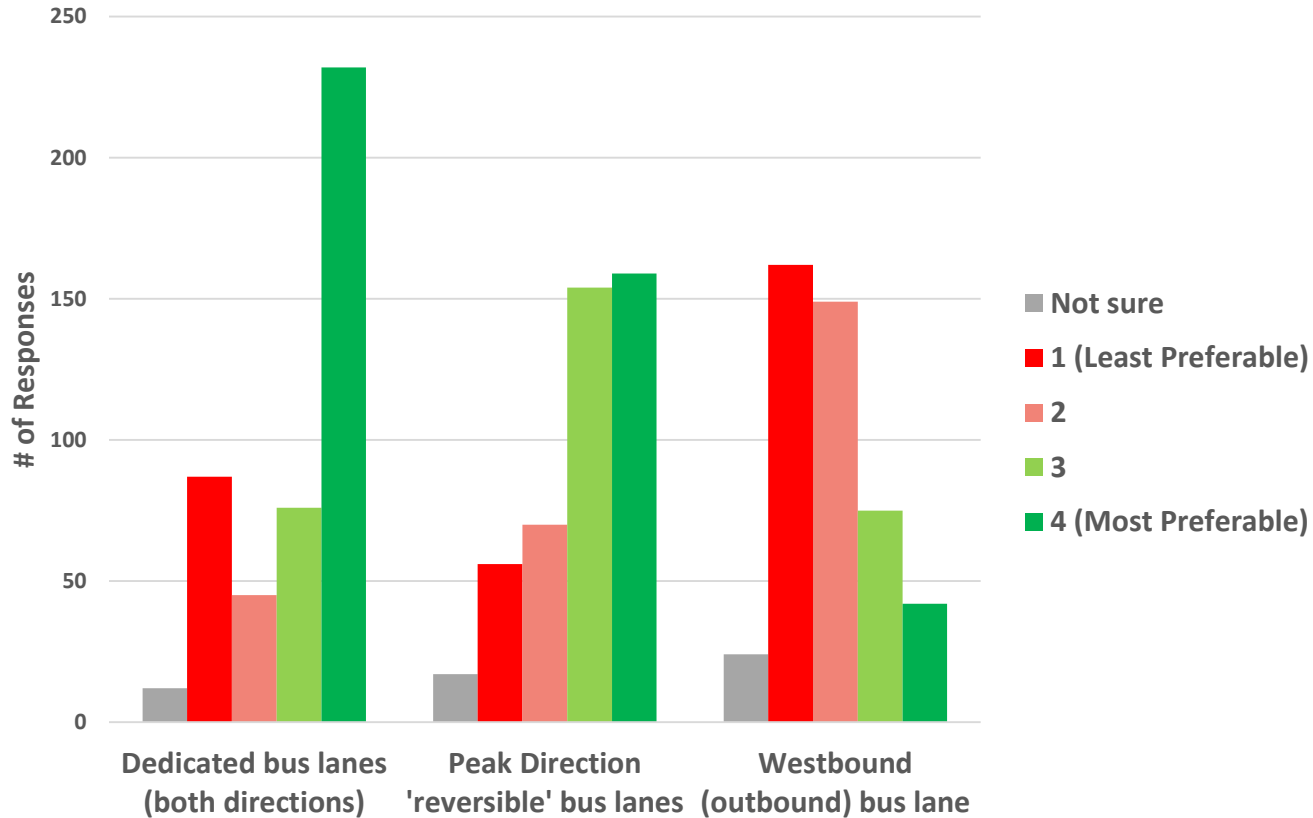

Bayers Road

Section 4 (Connolly Street to Windsor Street):
Indicate your preference based on the presented concepts

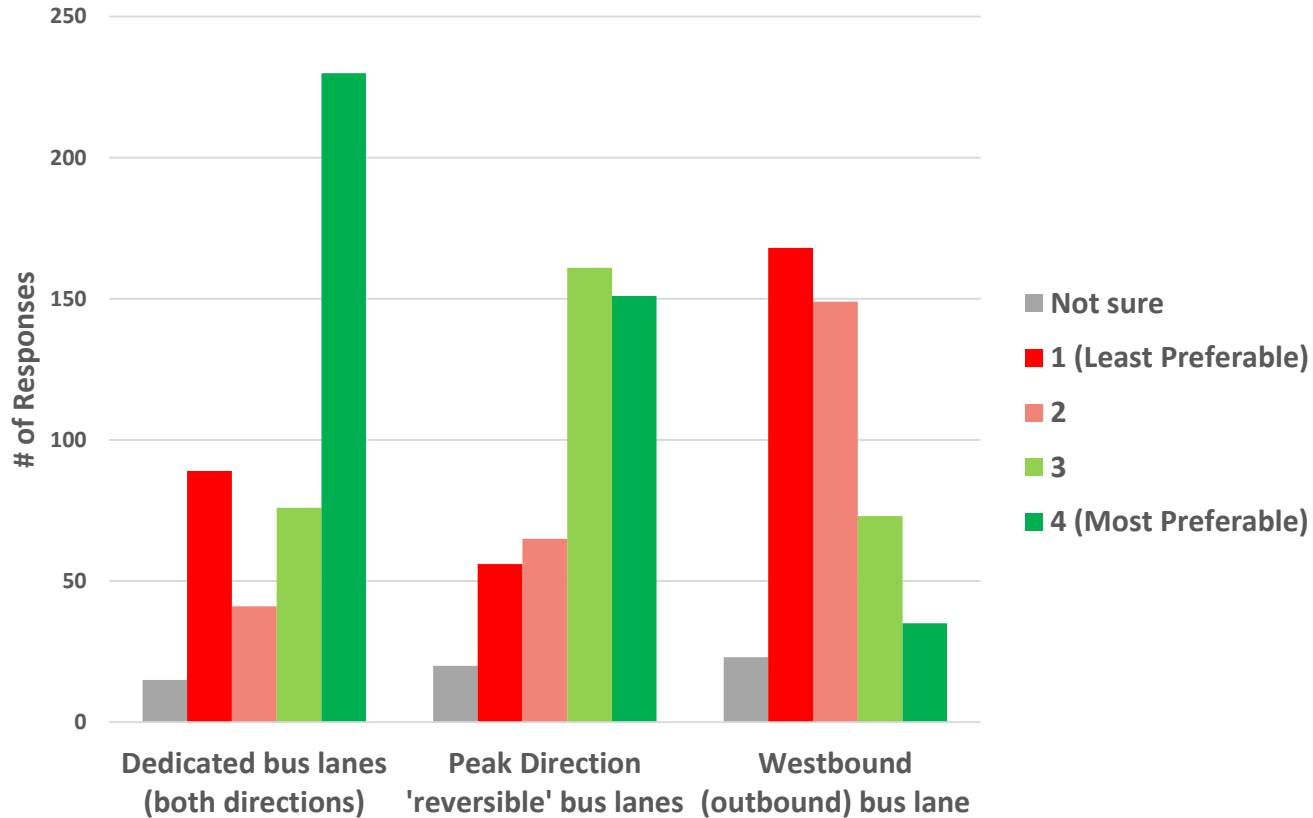

Gottingen Street

Shape Your City Online Survey	273
Paper Survey	23
Total Participants	296

Gottingen Street

How often do you use Gottingen Street?

of Responses

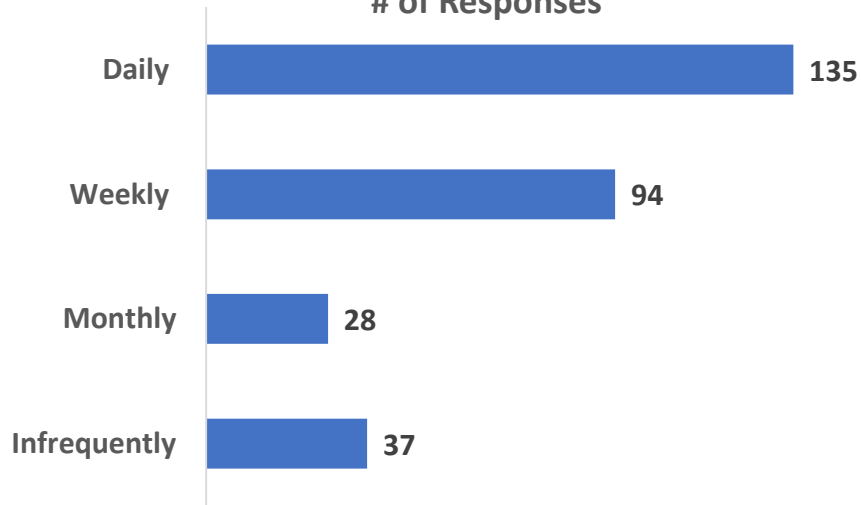

How do you usually travel on Gottingen Street?

of Responses

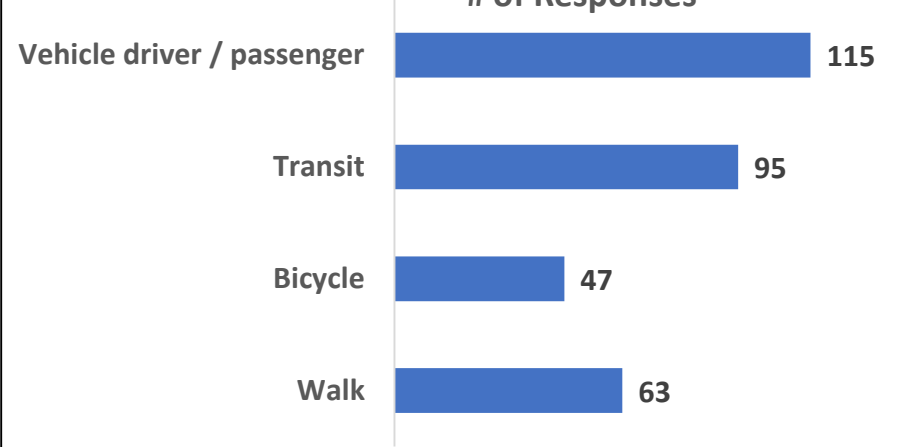

Gottingen Street

What matters most to you when you use Gottingen Street? (select up to 3)

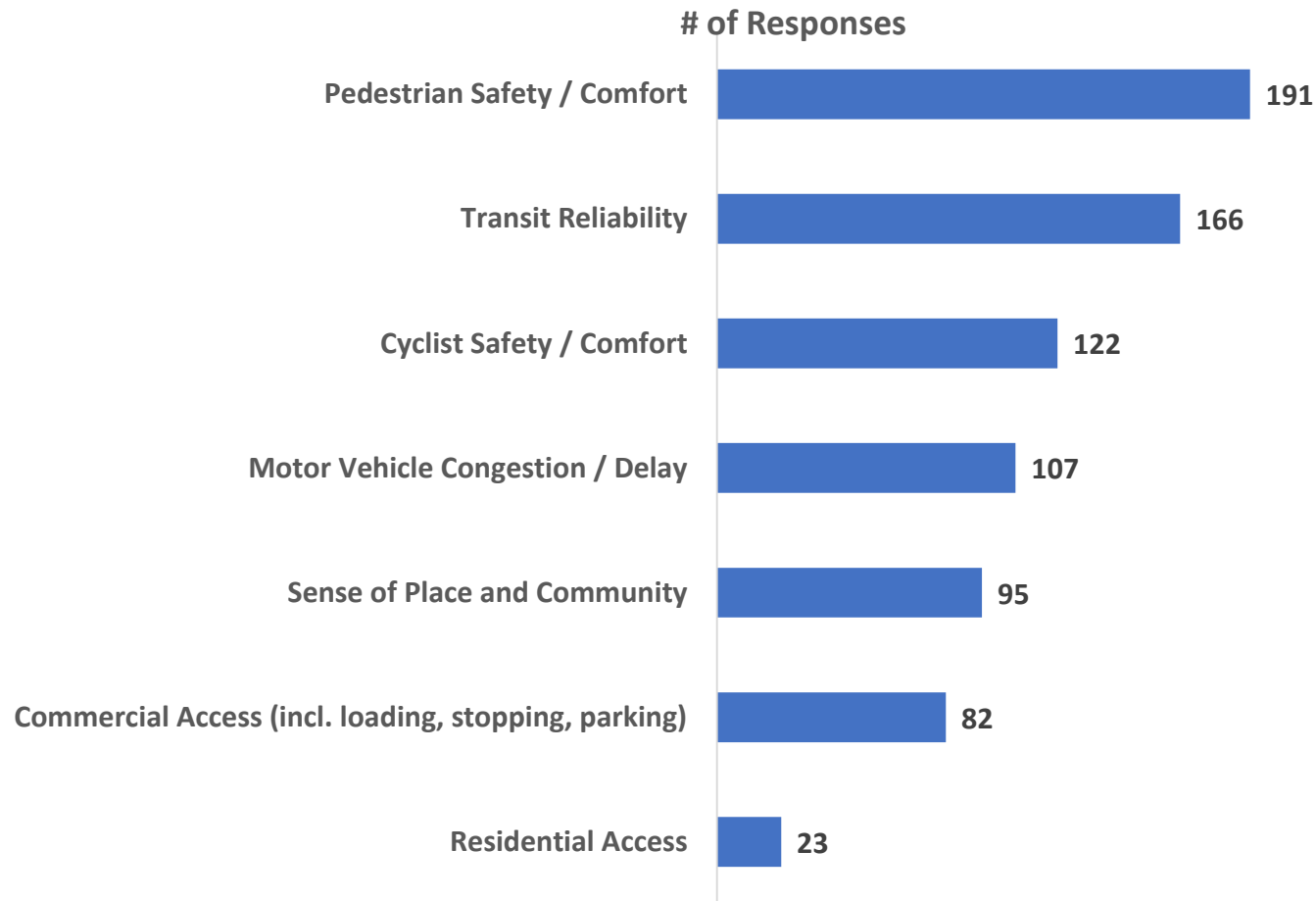

Gottingen Street

On a scale from 1-4 (where 1 is poor and four is excellent) how would you rate your experiences on Gottingen Street?

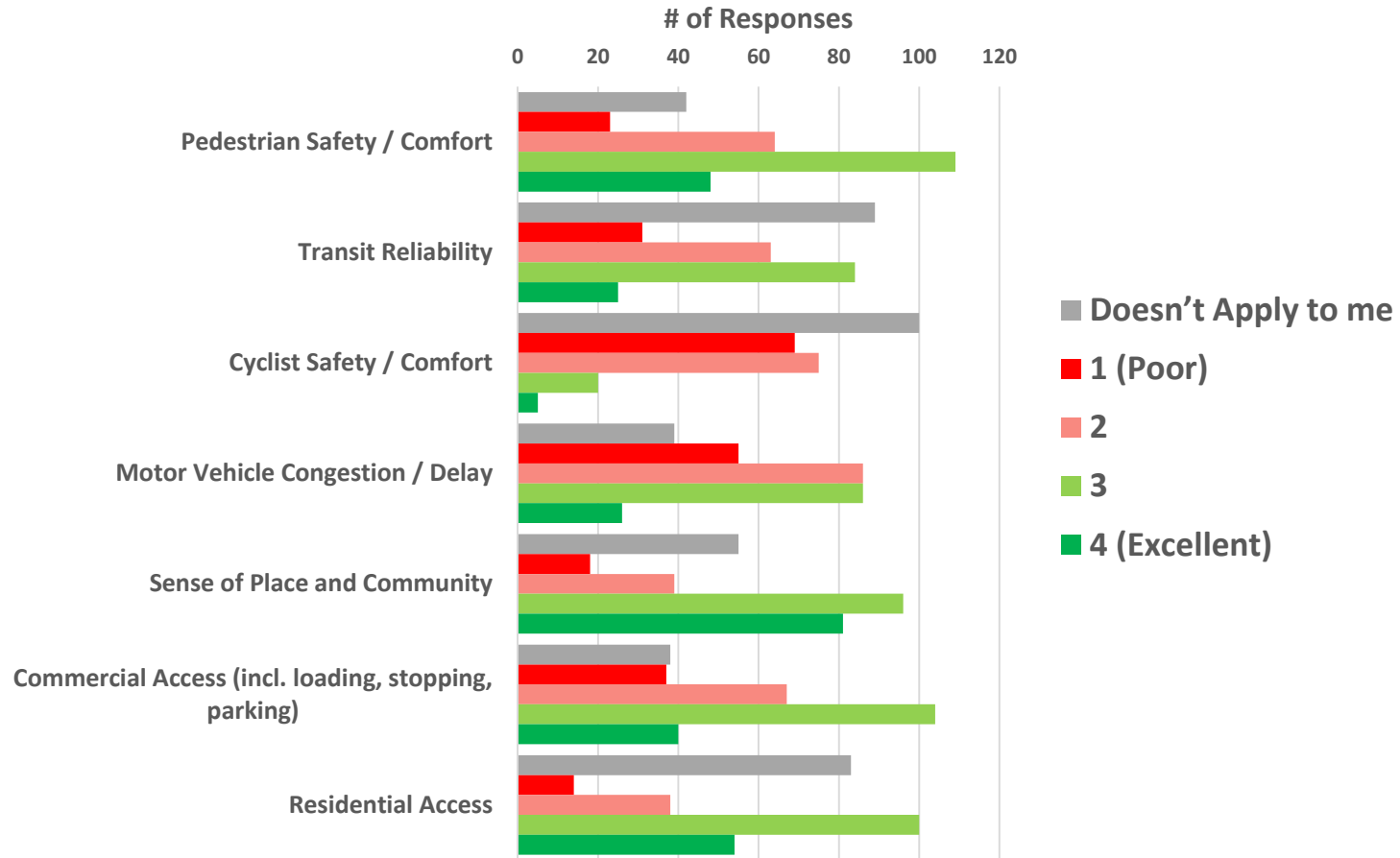

Gottingen Street

The addition of transit priority lanes on Gottingen Street may require trade-offs in some locations. How acceptable are the following potential trade-offs?

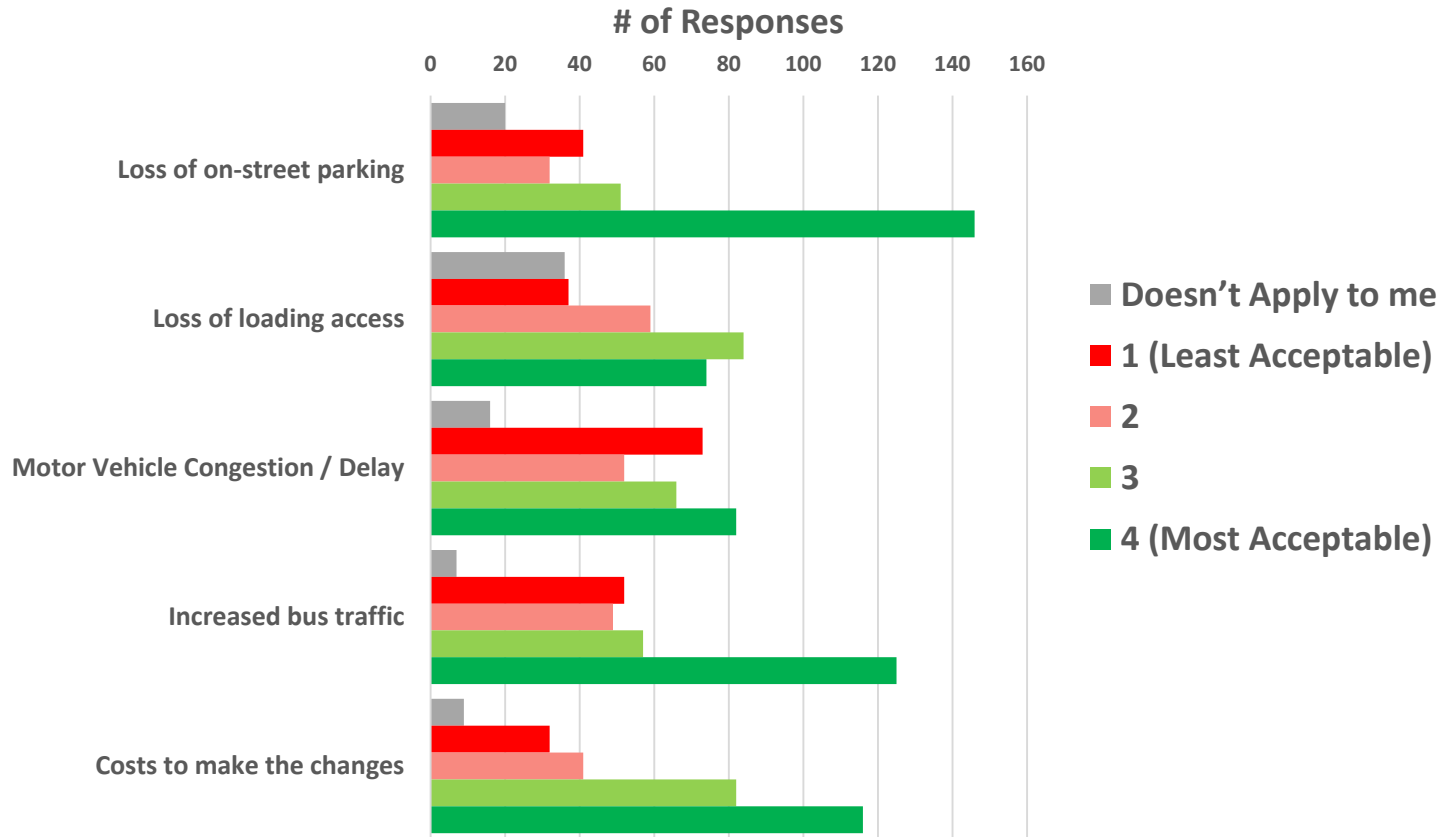

Gottingen Street

Section 1 (Cogswell Street to Cornwallis Street):
Indicate your preference based on the presented concepts

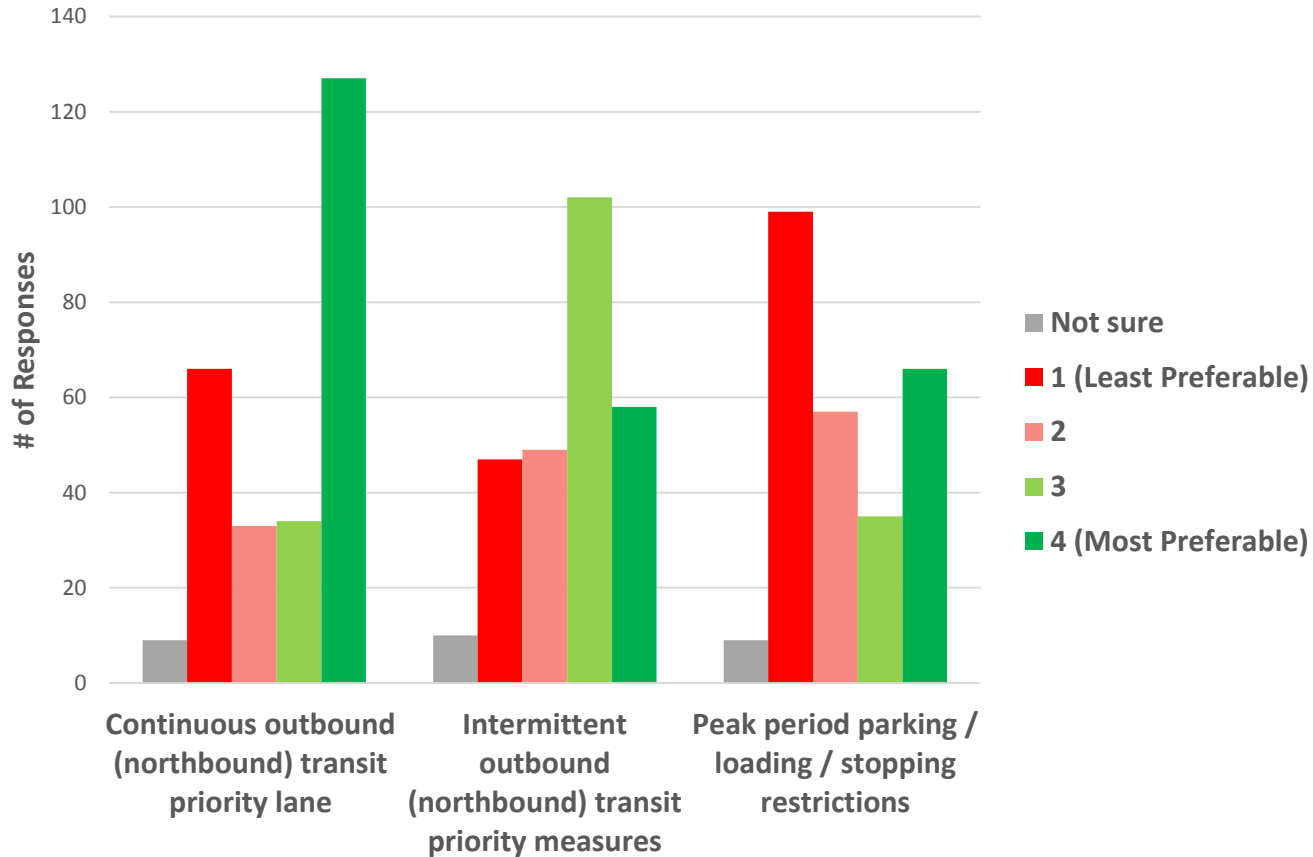

Gottingen Street

Section 2 (Cornwallis Street to Uniacke Street):
Indicate your preference based on the presented concepts

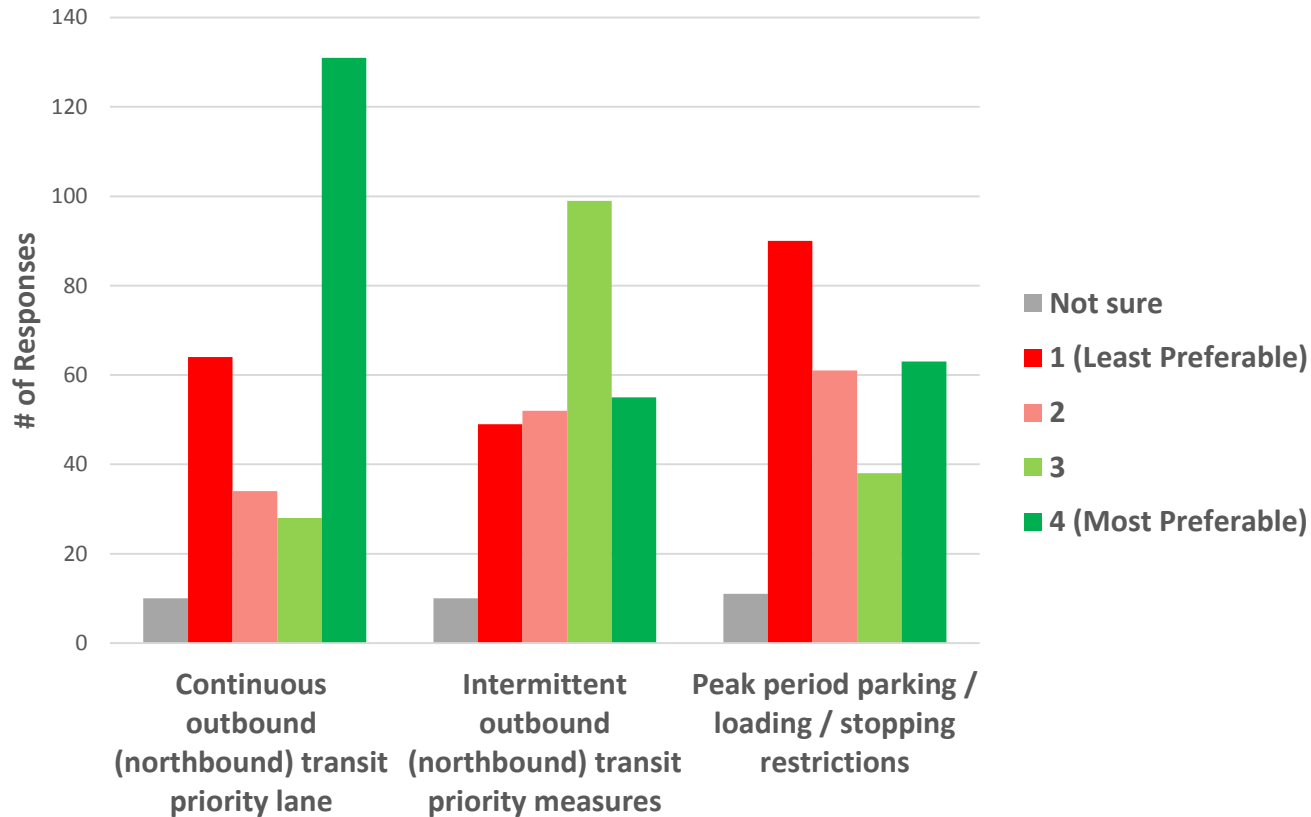

Gottingen Street

Section 3 (Uniacke Street to North Street):
Indicate your preference based on the presented concepts

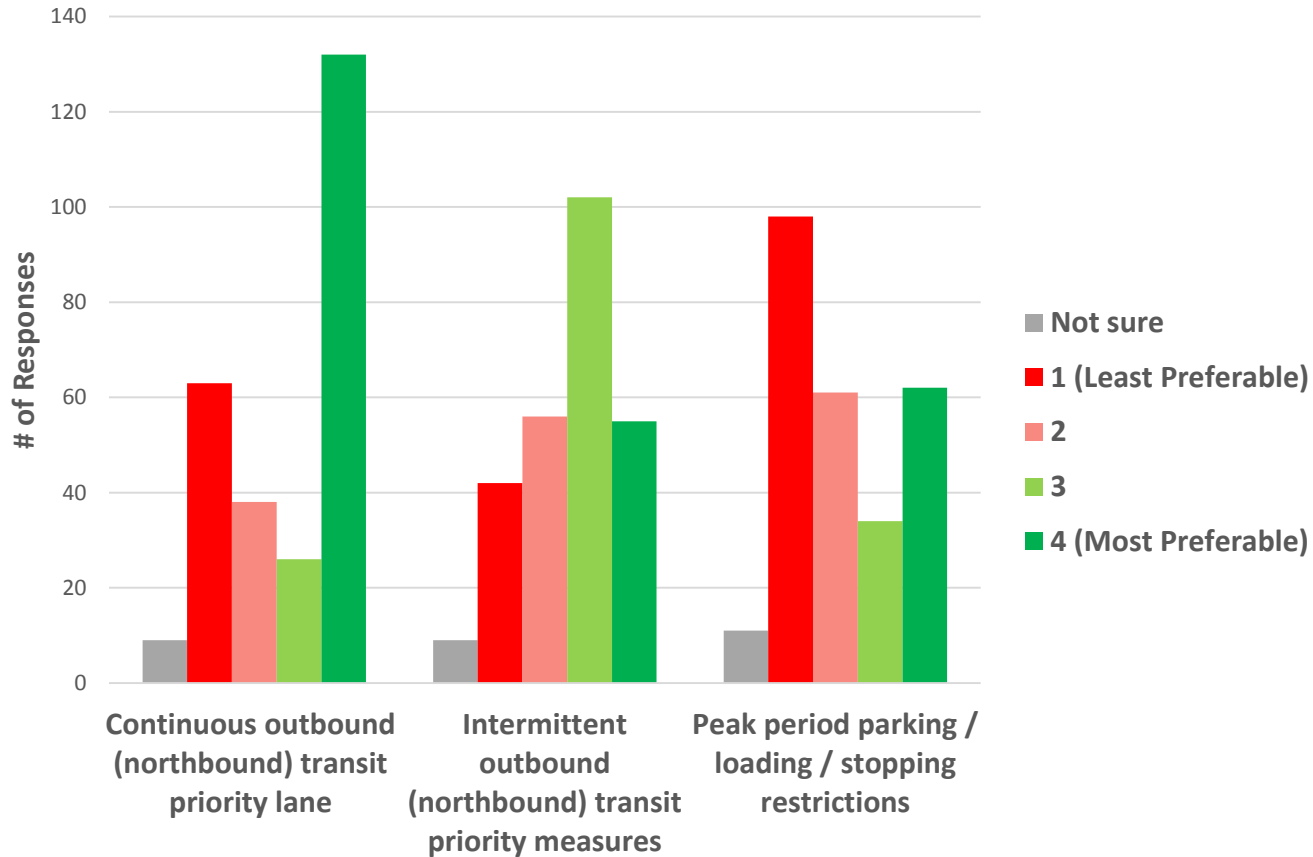

HALIFAX REGIONAL MUNICIPALITY

HALIFAX TRANSIT PRIORITY CORRIDORS – GOTTINGEN STREET AND BAYERS ROAD

JANUARY 2018



Project No. 171-09619



TABLE OF CONTENTS

1	INTRODUCTION AND BACKGROUND.....	1
1.1	Transit	1
1.2	Active Transportation (AT)	1
1.3	Study Area.....	2
1.4	Study Objectives.....	2
2	OVERVIEW OF EXISTING OPERATIONS	3
2.1	Traffic Congestion.....	3
2.2	Data Collection & Review	3
2.2.1	Topographic Survey and GIS data.....	3
2.2.2	Traffic Volumes.....	3
2.2.3	Transit Data	4
2.2.4	Pedestrians and Bicyclists.....	4
2.2.5	Parking.....	4
2.2.6	Road Safety	5
3	PROJECT APPROACH / FRAMEWORK	7
3.1	Design Objectives / Considerations.....	7
3.1.1	Design Workshop.....	7
3.2	Stakeholder & Community Consultation	9
3.2.1	HRM Internal Stakeholders.....	9
3.2.2	External Stakeholder Engagement.....	10
3.2.3	Public Open House	12
3.2.4	Online Consultation	12
3.3	Analysis Framework	13
3.3.1	Vehicular Impacts (Transit and non-transit).....	13
3.3.2	Multimodal Level of Service (MMLOS)	13
3.3.3	Parking / Loading	15
3.3.4	Road Safety	15
3.3.5	Cost Estimates.....	15
3.3.6	Overall Analysis.....	15
4	GOTTINGEN STREET.....	17
4.1	Existing Conditions	17
4.1.1	Existing Transit.....	18
4.1.2	Existing Traffic.....	18
4.1.3	Existing Multimodal Analysis.....	18
4.1.4	Road Safety	18
4.1.5	Existing Parking.....	18
4.2	Gottingen Street Modification Options	19
4.3	Gottingen Street Options Evaluation	20

5	BAYERS ROAD.....	23
5.1	Existing Conditions.....	23
5.1.1	Existing Transit.....	24
5.1.2	Existing Traffic.....	24
5.1.3	Existing Multimodal Analysis.....	25
5.1.4	Road Safety.....	25
5.1.5	Existing Parking.....	25
5.2	Bayers Road Modification Options.....	26
5.2.1	Romans Avenue to Halifax Shopping Centre.....	27
5.2.2	Halifax Shopping Centre (HSC) to Connaught Avenue.....	28
5.2.3	Connaught Avenue to Windsor Street.....	30
5.2.4	Windsor Street Intersection.....	32
5.3	Bayers Options Evaluation.....	33
6	SUMMARY & RECOMMENDATIONS.....	35
6.1	Summary.....	35
6.2	Recommendations.....	36
6.2.1	Recommendations - Gottingen Street.....	36
6.2.2	Recommendations - Bayers Road.....	37

APPENDICES

A	FUNCTIONAL DESIGNS
B	PUBLIC CONSULTATION FEEDBACK FORMS
C	ONLINE CONSULTATION RESULTS
D	COST ESTIMATES
E	SAMPLE DELAY AND PAYBACK CALCULATIONS
F	GOTTINGEN STREET INTERSECTION CAPACITY ANALYSIS
G	BAYERS ROAD INTERSECTION CAPACITY ANALYSIS

1 INTRODUCTION AND BACKGROUND

1.1 TRANSIT

Recent and ongoing policy development efforts have made improvements to Halifax’s transit service a key priority for the Municipality. Specifically, Halifax Transit’s *Moving Forward Together Plan* (adopted by Regional Council in April 2016) includes bold moves that aim to improve transit service levels through increased priority, enhanced reliability, and reduced travel time. The bold moves are being made in support of the following four Council-endorsed ‘*Moving Forward Principles*’:

1. Increase the proportion of resources allocated towards high ridership services.
2. Build a simplified transfer based system.
3. Invest in service quality and reliability.
4. Give transit increased priority in the transportation network.



Among the key initiatives that the Municipality is considering for transit upgrades are Transit Priority Measures (TPMs) – strategically located street and intersection upgrades that provide priority for the movement of buses. TPMs provide opportunities to make notable improvements to transit operation, and can be particularly effective in locations where right-of-way (ROW) constraints limit the ability to implement more dedicated facility options. When used effectively, TPMs can provide significant network benefits to transit operation that can stem from time savings of as little as a few seconds at a time.

Building on HRM’s recent success of implementing TPMs at various locations, the Municipality is interested in investigating corridor-level transit priority upgrades that satisfy specific recommendations of the *Moving Forward Together Plan* including two “critical locations” that were identified for transit priority measures: **Bayers Road** and **Gottingen Street**. In particular it has indicated an “urgent need for Transit Priority Measures in the Bayers Road corridor in order to provide reliable service to transit users.”

1.2 ACTIVE TRANSPORTATION (AT)

Active Transportation Connection Study (WSP, 2016) identified alternatives for a multi-use AT facility that would provide a formal connection between the COLT (at Joseph Howe Drive) and George Dauphinee Avenue. That report recommended an offstreet AT greenway on the south side of Bayers Road be provided but identified complications with right-of-way requirements and the signalized crossings of the Halifax Shopping Centre Driveways.

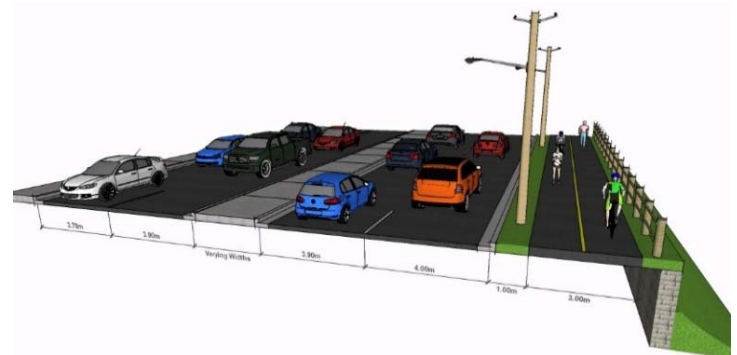

At the outset of this current study, HRM staff requested that consideration of an offstreet greenway south of Bayers Road between the study limits at Romans Avenue and George Dauphinee Avenue be included in the functional designs for all options through this segment.

1.3 STUDY AREA

The Study Area for this project includes the following corridors (shown in Figure 1-1):

1. Gottingen Street: North Street to Cogswell Street; and,
2. Bayers Road: Romans Avenue to Windsor Street.

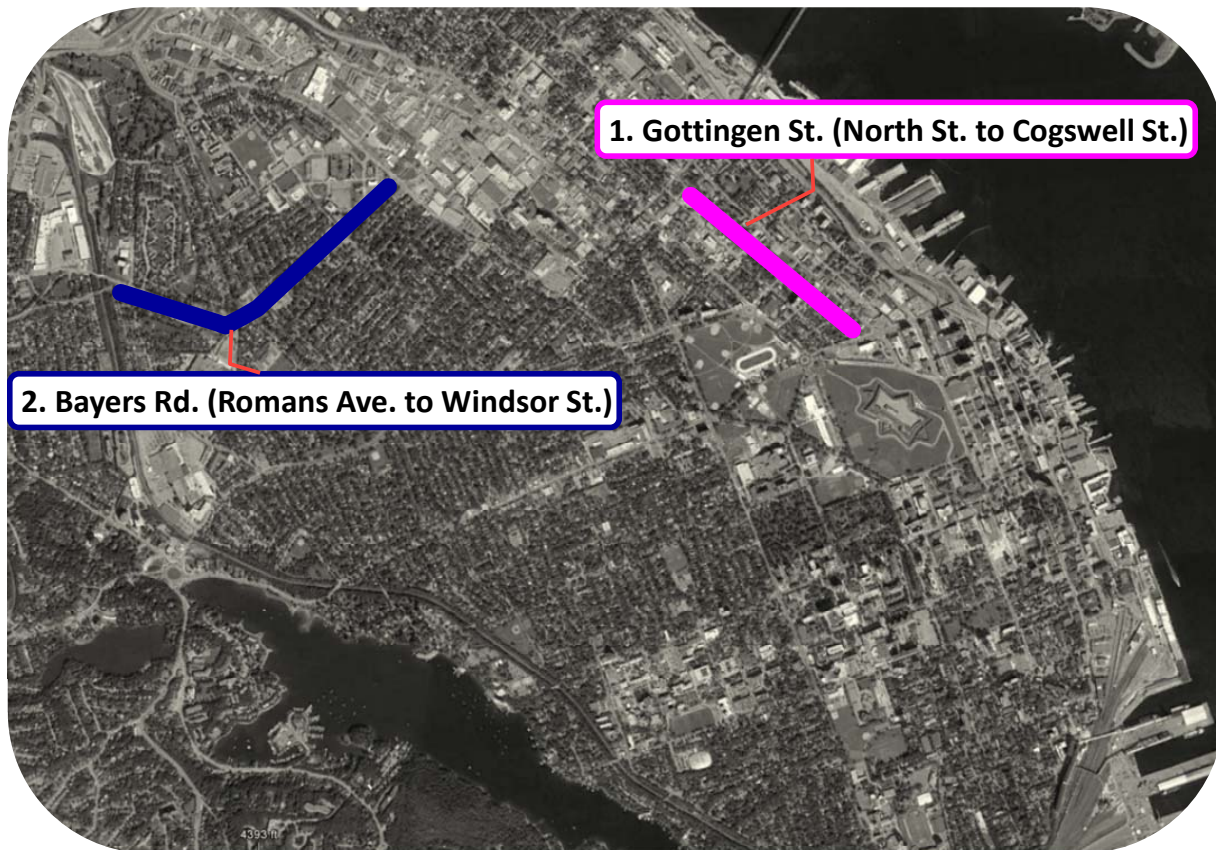

Figure 1-1 – Study Area Corridors

1.4 STUDY OBJECTIVES

The primary goal of this assignment is to develop and evaluate functional design options for transit priority along the study area corridors. Specific project objectives include:

1. Complete a detailed investigation of existing conditions within the Study Areas, including topographic survey and establishment of the functional operations of each street (i.e. traffic operation, transit delay, parking, loading, etc.);
2. Develop an understanding of existing and projected multimodal transportation demands;
3. Prepare functional design options and Class D Cost Estimates for each proposed option along each transit priority corridor;
4. Engage with key HRM internal stakeholders, external stakeholders, and the general public to identify the relevant constraints and obtain feedback on design options;
5. Complete assessments for each of the functional design options that focus on transit operational benefits, intersection performance, parking / curb access, and road safety considerations;
6. Prepare a design report that documents background information, summarizes key design assumptions and rationale, and provides comparative evaluation for each option.

2 OVERVIEW OF EXISTING OPERATIONS

2.1 TRAFFIC CONGESTION

Traffic congestion along the considered corridors has become an increasing concern in recent years. Long delays and queues have been observed throughout the study area, particularly westbound on Bayers Road during the PM peak period where travel times for traffic between Windsor Street and Connaught Avenue (a distance of approximately 800 metres) have been observed to exceed 15 minutes on a typical weekday. These long queues and high delays have led to shortcutting concerns in several adjacent residential neighbourhoods.

Moving Forward Together Plan (Halifax Transit, 2016) identifies the congestion on Bayers Road as a particular concern and recommends rerouting Transit Route #1 (Spring Garden) onto Roslyn Road, a local street, during the PM peak period “in order to maintain schedule adherence”.

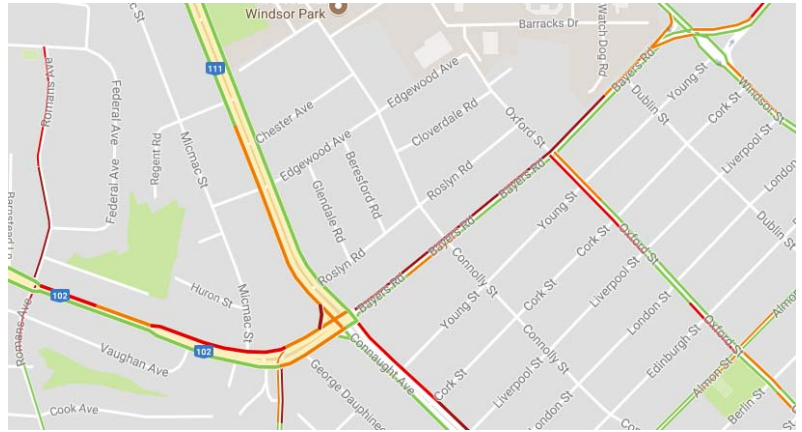

Figure 2-1 – Google Traffic Maps: 4:30 PM, Tuesday October 17, 2017

2.2 DATA COLLECTION & REVIEW

Significant data were collected at the outset of the project to develop an understanding of the existing topographic and traffic, transit, and active transportation demand along the considered corridors. The below sections summarize the methodology and results of this data collection.

2.2.1 TOPOGRAPHIC SURVEY AND GIS DATA

WSP’s survey team conducted a detailed topographic survey of the existing terrain of the corridors through the Study Area including the approach streets and abutting properties. The survey located, using real world coordinates, all relevant existing infrastructure including general site grades, curbs, power / communications systems, trees, and any other features that may affect the proposed designs. The data were imported into AutoCAD drawings for use as the topographic base for the design exercise.

The topographic field survey has been supplemented with HRM supplied GIS data and aerial imagery to identify the property boundaries and HRM right-of-way limits within the study area.

2.2.2 TRAFFIC VOLUMES

Intersection turning movement counts (collected between 2014 and 2016) and existing traffic signal timings for key study area intersections were provided by HRM Traffic Management for use in the review of existing traffic characteristics and analysis of intersection performance. HRM Traffic Management also provided historical 24-hour machine counts along each corridor for consideration of historical and anticipated growth trends.

GROWTH TRENDS

Traffic volumes collected by HRM along each corridor were analyzed in order to develop an understanding of traffic growth trends. Results (See Figure 2-2) do not indicate a clear growth trend for traffic volumes on study area routes.

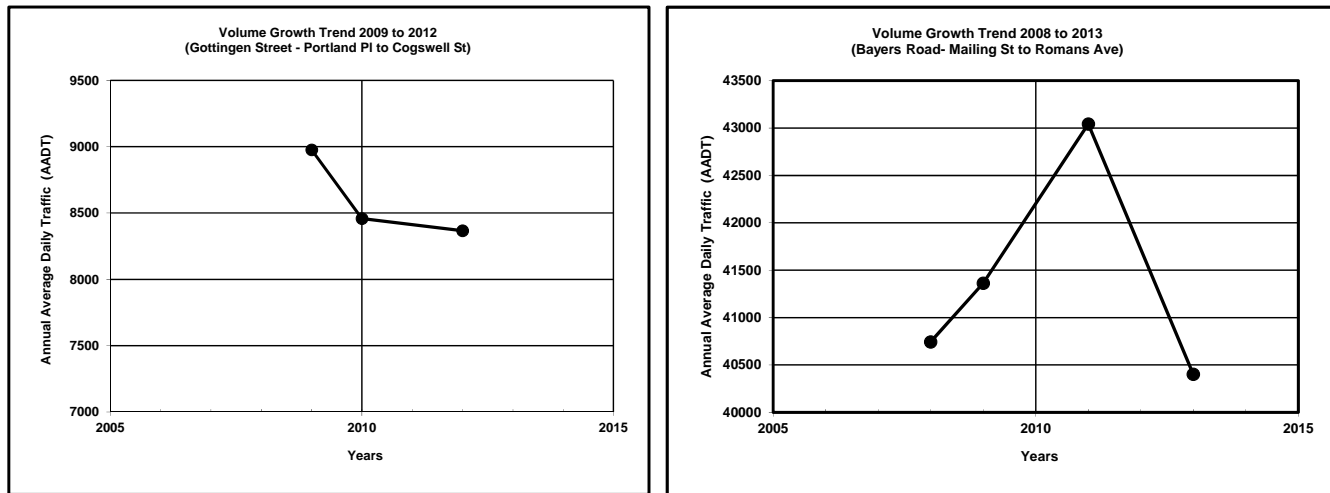

Figure 2-2 – Traffic Volume Growth Rates – Gottingen Street and Bayers Road

DESIGN HOURLY VOLUMES

Design hourly volumes were developed using the intersection turning movement count data collected by HRM Traffic Management. Based on a comparison of the count data with historical turning movement and machine count data (also provided by HRM), the intersection count data appear to be representative of typical conditions.

Given the lack of a clear historical trend of volume growth along these routes, the design hourly volumes have been estimated using the observed AM and PM peak hour volumes with no additional growth factors. Increased growth of traffic volumes would increase congestion in the analysis, increasing the need for transit priority.

2.2.3 TRANSIT DATA

Transit vehicle volumes and ridership data were provided by Halifax Transit for each existing transit route within the study area. No growth factor has been applied to the transit ridership or bus volume data. Additional transit travel time data were provided by Halifax Transit for buses along Gottingen Street.

Since there is some uncertainty of planned frequency for some of the future routes identified in *Moving Forward Together Plan* (Halifax Transit, 2016) and because ridership forecasts for these routes were not available for this project, transit vehicle and ridership volumes for existing routing were used in the analysis. It is recognized that each of the study area roads have been identified by Halifax Regional Council as Transit Priority Corridors and it is expected that transit ridership and bus volumes will likely increase, particularly with the implementation of corridor level transit priority measures.

2.2.4 PEDESTRIANS AND BICYCLISTS

Available pedestrian and bicycle volume data for the study area were provided by HRM Traffic Management.

2.2.5 PARKING

Field investigation was completed by WSP to inventory the location of existing parking along each of the studied corridors. Data on parking utilization were not available.

2.2.6 ROAD SAFETY



Road safety is an important component of any design, including transit facilities. A literature review of available road safety research was completed for this project to consider the collision history along different types of transit facilities. In conducting the review, several studies were found that provided collision data for different types of transit facilities, however, no such studies were found that provided reliable data within the Canadian or American context. Most of the available research used data from Mexico, South America, India, and Australia.

Sources:

<http://www.wrirosscities.org/sites/default/files/Traffic-Safety-Bus-Priority-Corridors-BRT-EMBARQ-World-Resources-Institute.pdf>

<http://trrjournalonline.trb.org/doi/pdf/10.3141/2402-02>

There are several types of lanes in Canada that are used by transit. The most common types are summarized below:

Transit Lane Type	Description	Results of Literature Safety Review
Mixed Traffic	Transit vehicles travel in mixed use lanes and navigate congestion with other road users. This is considered the baseline scenario and represents the existing conditions on study area streets.	
Curbside Bus Lanes	The curb lane can be designated as a transit lane for the same travel direction. 	The conversion of conventional bus service to bus priority with queue jump lanes and transit signal priority was found to reduce total collisions in Melbourne, Australia by 11% while injury collisions were reduced by 25%. http://www.wrirosscities.org/sites/default/files/Traffic-Safety-Bus-Priority-Corridors-BRT-EMBARQ-World-Resources-Institute.pdf
Median Bus Lanes	 Median bus lanes provide a designated transit lane in the centre of the street. Stops are provided at specific points and left turns are only permitted at signalized intersections with protected only phases, eliminating transit conflict with turning vehicles.	The literature review identified several projects where median bus lanes offered significant safety benefits overall when compared to other transit facility types, due to reduced vehicle conflict points with vehicles. Although benefits may be realized, careful consideration of left turns and pedestrian crossings and overall road width are required.

This Space Intentionally Left Blank

3 PROJECT APPROACH / FRAMEWORK

3.1 DESIGN OBJECTIVES / CONSIDERATIONS

The design objective for this project is to provide priority for transit along each corridor while also considering active transportation, traffic operations (including heavy vehicles) as well as the impact to parking and adjacent properties. The considerations are summarized in Table 3-1.

Table 3-1 - Project Considerations

Factor	Evaluation Considerations
Halifax Transit	Efficient movement of buses through the study corridors is a key consideration of this project. Design options have reviewed the ability of buses to navigate through the intersections and along the corridors with consideration given to the estimated and observed delays under existing conditions and the potential to improve transit operation through transit priority.
Active Transportation (Pedestrians / Cyclists)	Accommodation of active transportation is very important to HRM and the provision of sidewalks and safe street crossings is an important consideration. Bayers Road in particular has been identified as a candidate for an active transportation greenway in the HRM AT plan. Evaluation of each design option based on pedestrian and cyclist accommodation will focus on the extent to which key inputs such as pedestrian / cyclist exposure to vehicular traffic (i.e. crossing distances) are expected to change with implementation of each option.
Vehicular Traffic	Both Bayers Road and Gottingen Street in the project study area are classified as arterial streets with Bayers Road serving as a key truck route to Peninsular Halifax. Ideally, vehicular capacity should remain consistent with existing conditions. The approach to assessment of impacts to vehicular traffic includes performance analysis of the intersections and the corridors under consideration. Intersection performance analysis, completed using Synchro / SimTraffic is the basis upon which intersection capacity requirements (i.e. lane configurations, # of lanes) are determined. Comparison of results among the design alternatives enables understanding of the impact that each has on vehicular traffic performance.
Parking / Loading	The available parking and loading has been identified along the study area corridors. Impacts to parking and loading have been considered in the analysis.
Right-of-Way Impacts	Consideration has been given to the impacts of roadway expansion. Where available, properties already owned by HRM were considered first and where necessary, property acquisition has been identified. Other impacts on adjacent properties (i.e. grading) were also considered in the options analysis.

3.1.1 DESIGN WORKSHOP

A Functional Design Workshop was held early in the design phase with HRM staff to discuss innovative, yet feasible options for transit priority measures along each corridor. A discussion on prioritization within a transit priority corridor began the workshop. Although it was recognized that precise priorities for each corridor and section of each corridor is highly context sensitive, the group came to a consensus that right-of-way prioritization for the transit corridors were be as follows:

- | | |
|-----------------|-----------------------------------|
| Higher Priority | 1. Sidewalk |
| ↓ | 2. Transit and transit stops |
| | 3. Non-Transit Traffic |
| | 4. Deliveries and Loading |
| | 5. Parking (Vehicular / Bicycles) |
| | Lower Priority |

Throughout the workshop, the group discussed design options for sections and key intersection along each of the corridors. The following is a summary of key highlights:

GOTTINGEN STREET

- Gottingen Street has a number of challenges including limited right-of-way and a number of uses that compete for space (e.g. on-street parking and loading, traffic, transit, cyclists, pedestrians).
- Options for traffic divergence to adjacent streets (i.e. one way on Gottingen Street) were discussed however there were concerns with having an increase of traffic on adjacent local streets.
- Removing on-street parking during peak hours were discussed and should be considered in the functional design options.
- Options for how to make Gottingen Street a transit priority corridor must be well thought out. It is highly used by pedestrians with currently limited sidewalk space, it has an active business community and is a dense residential community directly on and adjacent to the corridor. Existing built forms have little to no setbacks off of Gottingen Street which makes road widening not feasible.

BAYERS ROAD: ROMANS AVENUE TO CONNAUGHT AVENUE

- Agreement that two curbside transit lanes (one in each direction) should be considered. This option however, would require widening of the right-of-way.

BAYERS ROAD: HALIFAX SHOPPING CENTRE AND CONNAUGHT AVENUE INTERSECTIONS

- This section was identified as a significant challenge along the corridor. The two intersections are closely spaced together and result in traffic queues from all approaching directions during peak times.
- HRM owns property to the north (between the two intersections) which could be incorporated to alleviate traffic congestion in this area.
- Design options ranging in level of investment were discussed and included building an overpass across the HRM owned property (high investment), to realigning lanes and signals timing (low investment).

BAYERS ROAD: CONNAUGHT AVENUE TO WINDSOR STREET

- Two full-time transit lanes along this segment should be considered that would require a high level of investment.
- Currently, there are high transit volumes traveling on this segment of the corridor, so a high investment option may be worth implementing.
- Having bi-directional bus-only lanes may require road widening and elimination of a west-bound traffic lane.
- Other options requiring lower levels of investment (and lower impacts to adjacent residential properties) will need to be considered.

BAYERS ROAD: BAYERS ROAD/ YOUNG STREET/ & WINDSOR STREET INTERSECTION

- Options for a roundabout were discussed, however it is difficult to incorporate a bus-only lane with this design option.
- Other options must be considered that would involve bus-only transit lanes to travel through the intersection efficiently.

3.2 STAKEHOLDER & COMMUNITY CONSULTATION

One of the key aspects of this project was the consultation with stakeholders and the public at large. Separate meetings were held with HRM staff, stakeholder groups external to the municipality, and with the public through Open House style meetings.

3.2.1 HRM INTERNAL STAKEHOLDERS

A meeting was held with HRM Internal staff who provided insight in various areas of expertise related to TPM on the identified corridors. Attendees represented the following areas of interest and expertise:

- Strategic Transportation Planning
- Traffic Management
- Parking Management
- Halifax Transit
- Streetscaping and Active Transportation
- Planning and Development
- Urban Forestry
- Cogswell Redevelopment Project

The following is a summary of what we heard from HRM staff:

GOTTINGEN STREET

- Currently, the congestion of buses during PM peak periods spills over on to Cogswell Street. Need to consider how to improve this situation.
- The Macdonald Bridge bikeway overpass will change the intersection alignment at Gottingen Street and North Street.
- Existing off-street paid parking on the corridor will be used for development (making it unavailable for public parking in the future). A parking analysis will need to be done prior to any decisions being made.
- Parking for local businesses will be of concern. Want to try to make sure we don't have a net loss of parking in the area. If spaces on Gottingen Street are removed, where will they be replaced? Adjacent side streets?
- If higher order bus stops are being planned, consider the setbacks needed for them. The right of way is pretty tight as it is.

BAYERS ROAD

- There is currently a plan to implement a 3 metre multi-purpose trail for Active Transportation between Vaughan Ave. and George Dauphinee Ave.
- Currently, streetscaping along the west end of Bayers Road is not conducive to pedestrian use. Vaughan Ave. is a more pleasant walk for pedestrians as it is (quieter, safer, and less stressful).
- The forthcoming Centre Plan has policy outlining the importance of developing on corridors and identifies that greater front yard setbacks on new developments will be required. These setbacks will reflect the likely need for the Municipality to acquire land in the future.
- Staff identified there is an opportunity for **alignment of Transit Priority Measures with the Centre Plan.**
- Must consider the impact of trees, (individual stands as well as on the mix of species in an area) along the corridor. There are large elms on Bayers Road before Connaught Ave.
 - Also need to consider how to build projects in the city and still achieve the goals set in the Urban Forest Master Plan. If trees need to be removed, can more be planted elsewhere (i.e. on other parts of the right-of-way or on private property)?
- On-street parking may be an issue on the east end of the corridor.
- A particularly challenging issue will be between the Halifax Shopping Centre and Connaught Ave. Should look at traffic numbers coming to and from the Halifax Shopping Centre.

3.2.2 EXTERNAL STAKEHOLDER ENGAGEMENT

Separate meetings with stakeholders external to municipal staff were also held. Project information and consultation meetings were held with the Halifax Utility Coordinating Committee (HUCC), the North End Business Association (NEBA), and various community advocacy groups. The following is a summary of feedback provided from each of the external stakeholder meetings.

HALIFAX UTILITY COORDINATING COMMITTEE (HUCC)

- Prior to any construction, HUCC members will need to know whether or not utility relocation is required.
- A change in curbs will be their biggest concern. These will have impacts of where their services are located.
- Currently the right-of-way on Gottingen Street is very tight. Relocation will be costly.
- Bayers Road: Bell Aliant has a major cross-section of cable routes along this corridor. If this cross section had to be moved, it would be very costly and time consuming.
- Will federal infrastructure money help pay for the costs to relocate utilities?

NORTH END BUSINESS ASSOCIATION (NEBA)

- Highly concerned about having Gottingen Street designated as a TPM corridor.
- Having on-street parking and loading available for businesses is essential for commercial viability.
- Currently, the buses on Gottingen Street are loud and noisy. If more buses travel on Gottingen Street, NEBA felt this will worsen these negative impacts and degrade the street's public realm.
- During non-peak periods, members of NEBA indicated that few passengers are actually on the buses that travel down Gottingen Street. NEBA members asked how Halifax Transit can make their routing more efficient/more effective for moving people without having under-utilized buses travel the corridor?
- The Link and express buses turn Gottingen Street into a “bus highway”. NEBA indicated that the community doesn't want buses traveling through the corridor if they're not actually serving the immediate community.
- NEBA felt that buses (especially Link or express routes), should be using Barrington Street to move north. NEBA asked Halifax Transit to work with the Bridge Commission to fix the geometry of the ramp to the Macdonald Bridge so that buses can be accommodated and re-routed from Gottingen Street.
- NEBA felt that putting more buses on the corridor will negatively impact businesses on Gottingen St. Members indicated that it has taken years to bring life and vibrancy back onto the street.
- Attention should be given to the crosswalk at Gottingen Street & Buddy Daye Street. This is frequently used (by children) and doesn't have great visibility to drivers.

COMMUNITY ADVOCACY GROUPS

Members from community advocacy groups came together for a project introduction and consultation meeting. The following groups were represented at this meeting:

- Walk n Roll
- Halifax Cycling Coalition
- DalTrac
- It's More than Buses
- Canadian National Institute for the Blind (CNIB)

The following is a summary of what was heard:

GOTTINGEN STREET

- Similar concerns were voiced from community group representatives that had been heard from the NEBA meeting: noise and pollution impacts, should avoid turning Gottingen into a “bus highway”, concerns about the impacts of removing on-street parking for local businesses.
- Consider using TPM treatments on Gottingen Street to “brand” transit priority. I.e. consider colouring the pavement for the bus only lanes.
- The bike ramp off of the Macdonald Bridge will impact how cyclists use Gottingen Street. Coming off the bridge, using Gottingen Street seems to be a natural transition. However currently, the IMP has Brunswick as the dedicated cycling route. Does this make sense?
- The topic of making Gottingen Street a bus/pedestrian/cyclist only corridor (e.g. no cars permitted) was discussed. This option could have the potential of improving the public realm by implementing bicycle infrastructure, widening sidewalks, as well as giving transit the space it needs to move through effectively.
- Similar to Bayers Road, HRM needs to consider accessibility planning. For the visually impaired, it is much easier to delineate the sidewalk and roadway when there is landscaping/grass between the curb and the walking area. Audible bus stops are also recommended to accommodate the visually impaired.
- How will TPM impact cyclists? Need to make sure these measures are not to their detriment.

BAYERS ROAD

- Community Group representatives felt that there is a difference between this proposal for road widening, and the one that happened 8-10 years ago on Bayers Road. If road widening is happening to bring more buses on the road (and not cars), there will likely be less resistance and more acceptance to the project.
- Community Group representatives suggested HRM should consider congestion pricing – tax personal motor vehicles going into the peninsula. This will be easier (and less money) than doing road widening.
- Representatives indicated that this is an opportunity to turn Bayers Road into a true Complete Street. It is currently in desperate need for a pedestrian and cycling realm improvement. Bayers Road could be the “poster child” for Halifax’s complete streets.
- HRM needs to consider accessibility planning: consider sidewalk access, audible bus stops, grades, etc.

3.2.3 PUBLIC OPEN HOUSE

Two open houses, (one focused on Bayers Road, and the other focused on Gottingen Street), were held for members of the public to review the proposed functional design options along each of the two corridors. Using panel displays, residents were shown design options for segments of the corridor ranging from high investment (giving transit greatest priority), medium investment, and low investment (giving transit minimal priority). With each design option, a summary of user impacts were provided as well as an overview of pros and cons should the design be implemented. Residents were asked to provide their feedback and indicate which of the design options they prefer (if any at all). Copies of the public open house boards for both Gottingen Street and Bayers Road are included in Appendix A while comment feedback for each are presented in Appendix B.



Photo 1 - Gottingen Street Open House - October 2, 2017



Photo 2 - Bayers Road Open House - September 28, 2017

3.2.4 ONLINE CONSULTATION

An online survey was commissioned by the HRM project team to gather further public input on the display boards (Appendix A) and made available on the project's Shape Your City website. Paper copies of the survey were also made available at each of the two Open Houses. Results of the survey have been generated by HRM staff and have been presented in Appendix C.

The following are key highlights from the online survey for each of the two corridors:

GOTTINGEN STREET, n = 296

- Forty percent of survey participants travelled the corridor in a personal motor vehicle. Sixty percent travelled through on transit, bicycle, or as a pedestrian.
- Pedestrian safety and comfort was the most important issue that mattered to survey participants with over half indicating their current experience with pedestrian safety and comfort were good or excellent.
- Loss of on-street parking was the most acceptable trade-off with the addition of a transit-only lane. Motor vehicle congestion or delay was the least acceptable.
- For all corridor sections, the High Investment option was identified as the most favourable among survey participants.

BAYERS ROAD, n = 488

- Over half of respondents usually travelled through the corridor in a personal motor vehicle (as a driver or as a passenger).
- Transit reliability was the most important issue that mattered to survey participants and over half indicated their current experience with transit schedules were considered poor.
- Loss of on-street parking was the most acceptable trade-off with the addition of a transit-only lane while increase of motor vehicle congestion or delay was the least acceptable.
- For all corridor segments, the High Investment option was the most favourable among survey participants.

3.3 ANALYSIS FRAMEWORK

The analysis of each option includes consideration of impacts on Transit Operations, Multimodal Level of Service, Traffic, Parking/Loading, and Property Impacts. The analysis framework for each of these considerations is described in the subsequent sections.

3.3.1 VEHICULAR IMPACTS (TRANSIT AND NON-TRANSIT)

In *Halifax Transit Priority Measures Study* (WSP, 2016) an analysis framework was developed to consider the costs and benefits to transit and the overall public of a given transit priority measure. That methodology has since been included as Appendix E in *Moving Forward Together Plan* (Halifax Transit, 2016) as the methodology used for the evaluation of transit priority measures. This methodology follows the following five steps:

1. **Develop estimates for the Capital Cost** using preliminary cost estimates based on functional designs.
2. **Develop estimates for annual operating cost** using approximate costs for similar measures.
3. **Develop operational cost savings to Halifax Transit** using estimates in delay reductions to transit vehicles. This can be obtained from field observation or traffic modeling and a combination of both have been used for this project.
4. **Understand the TPM's Impact to All Road Users** using estimates in changes in delay to the movement of people using the particular intersection or corridor. This includes changes in delay to transit users as well as any estimated change in delay to motorists, cyclists, or pedestrians.
5. **Determine the payback period for the Measure** using the results of the previous four steps.



To estimate the impact on transit flow that could be expected with each option along each corridor, the delay reductions to the average transit vehicle have been estimated using traffic analysis (Synchro 9 and SimTraffic) and supplemented with field observation and transit data provided by Halifax Transit. This analysis has been carried into the cost analysis and overall evaluation. The methodology to calculate the delay and payback period are included in Appendix E.

3.3.2 MULTIMODAL LEVEL OF SERVICE (MMLOS)

Multimodal level of service (MMLOS) is an evaluation framework that takes a more holistic approach to intersection performance analysis than the typical vehicle-focused models that are commonplace. The framework for MMLOS is based on *NCHRP Report 616* (National Cooperative Highway Research Program NCHRP, Washington, 2008), a publication that summarizes the results of a 2-year investigation of how users perceive the multimodal quality of service on urban streets. LOS models were calibrated that rate the level of comfort and delay felt by pedestrian, bicycle, and transit users at an intersection and along a corridor and enable the analysis of “tradeoffs” of various allocations of the urban street cross section among auto, pedestrian, bicycle, and transit users. The intent is to provide a more complete representation of how key variables impact the accommodation of different road users.

The NCHRP framework for MMLOS has been applied to evaluate design alternatives for the study area. The following summarizes the NCHRP framework and how it was applied to this project:

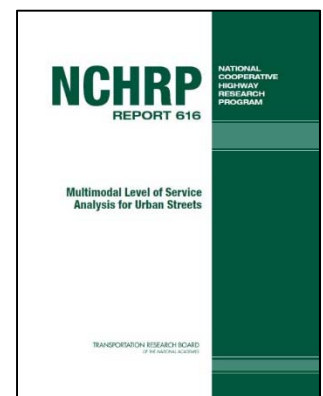

- NCHRP 616 included MMLOS models for corridors and signalized intersections only.
- Although there are transit multimodal level of service models for corridors, the factors for transit LOS consider transit scheduling and transit amenities (benches, shelters) that are outside the scope of this project. Evaluation of transit performance along each corridor has been performed separately.
- *Highway Capacity Manual 2010* (HCM 2010, National Academy of Sciences, Washington, 2010) used the research and models included in NCHRP 616 to provide MMLOS models for intersections and segments in HCM 2010. New to HCM 2010 was the MMLOS criteria for pedestrians at Two-way STOP controlled intersections (TWSC); however, HCM 2010 does not provide bicycle MMLOS at TWSC. Table 3-2 summarizes the factors that were found to influence the level of service of pedestrians and bicyclists.

Table 3-2 - Factors that influence Intersection Multimodal LOS by Active Mode (HCM 2010)

		Pedestrian LOS	Bicyclist LOS
Signalized Intersection MMLOS	Negative Influence	<ul style="list-style-type: none"> • Volume of right turns on red • Volume of permitted left turns • Traffic in outside lane • Traffic speed • Number of lanes • Pedestrian delay • Right-turn channelized lanes (low traffic volume locations) 	<ul style="list-style-type: none"> • Width of cross street • Volume of traffic
	Positive Influence	<ul style="list-style-type: none"> • Right-turn channelized lanes (high traffic volume locations) 	<ul style="list-style-type: none"> • Width of outside through lane (and bicycle lane) • Number of lanes on approach direction
Two-Way STOP-Controlled Intersection MMLOS	Negative Influence	<ul style="list-style-type: none"> • Vehicle volume • Crosswalk length • Number of lanes 	No model provided
	Positive Influence	<ul style="list-style-type: none"> • Crosswalk width • Driver yield rates 	
Overall Segment	Negative Influence	<ul style="list-style-type: none"> • Traffic volume per lane • Vehicle travel speed • Poor intersection MMLOS 	<ul style="list-style-type: none"> • Signalized Intersections • Traffic volume per lane • Vehicle travel speed • Heavy vehicle volume • Poor intersection MMLOS
	Positive Influence	<ul style="list-style-type: none"> • Width of outside through lane (and bicycle lane) • Parking occupancy • Presence of sidewalk buffer • Sidewalk width 	<ul style="list-style-type: none"> • Width of outside through lane (and bicycle lane)

3.3.3 PARKING / LOADING

WSP has conducted field review to quantify the available parking / loading along each corridor and consider the impact to parking and loading with each option.

3.3.4 ROAD SAFETY

WSP has reviewed available collision records and how the options could be expected to impact road safety through changes to the number of conflict points and expected travel speeds.

3.3.5 COST ESTIMATES

With each option developed for these corridors, Class D cost estimates have been prepared to estimate the construction cost. These estimates are considered high level estimates and do not include property acquisition or HST. Cost Estimates for each option are included in Appendix D.

3.3.6 OVERALL ANALYSIS

Using consideration of the above factors and results from the public and stakeholder consultation, overall evaluation matrices were developed for each corridor in order to display the overall assessment of each option and enable comparison between categories (identified in Table 3-3). For simplicity, the matrices has been formatted to a colour scale from green (most favorable) to red (least favorable), with yellow the intermediate shade. Grey was used to indicate criteria that were not applicable or where information was not available. It should be recognized that since this evaluation scheme does not apply weighting factors to the various evaluation criteria, it essentially assigns equal value to each criteria. This is obviously not the case in reality, as transit schedule adherence may be a more influential factor on these identified transit corridors than traffic impacts. As presented, the evaluation matrix is a visual tool that enables high level options comparison.

Each option for the full corridor has also been evaluated using the payback period analysis methodology included in *Moving Forward Together Plan* (Halifax Transit, 2016) with the methodology shown in Appendix E.

Table 3-3 - Considered Categories for Analysis

	Transit Travel Time
	Transit Schedule Reliability
	Transit Visibility
User Experience	Walking
	Bicycling
	MMLOS
	Road Safety
Impacts	Traffic Impacts
	Property Requirements
	Green space / Urban Forest
	Implementation Cost
Public Support	Public Feedback Response

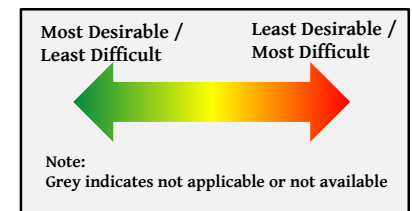

This Space Intentionally Left Blank

4 GOTTINGEN STREET

4.1 EXISTING CONDITIONS

Gottingen Street between Cogswell Street and North Street (approximately 1.1 km) is a two-lane arterial roadway. Traffic data obtained by HRM Traffic Management indicate a weekday two-way traffic volume of approximately 8,400 vehicles per day (vpd).

Along the corridor, the intersections of North Street, Cornwallis Street, and Cogswell Street are signalized. The remaining seven intersections (with Charles Street, Uniacke Street, Buddy Daye Street, Cunard Street, Falkland Street, and Portland Place) are all T-intersections with STOP control on the side street and free flow on Gottingen Street.

With approximately 10 metres of asphalt width on Gottingen Street south of Buddy Daye Street and intermittent parking available on both sides, the flow of transit and traffic vehicles are already impacted by the narrowed through lanes (See Figure 4-1).

Although much of this corridor is theoretically free flow, congestion has been observed throughout the day, particularly during the PM peak period when northbound traffic queues toward North Street extend along the corridor (See Figure 4-2).



Photo 3 - Queued outbound bus - 4:45 PM

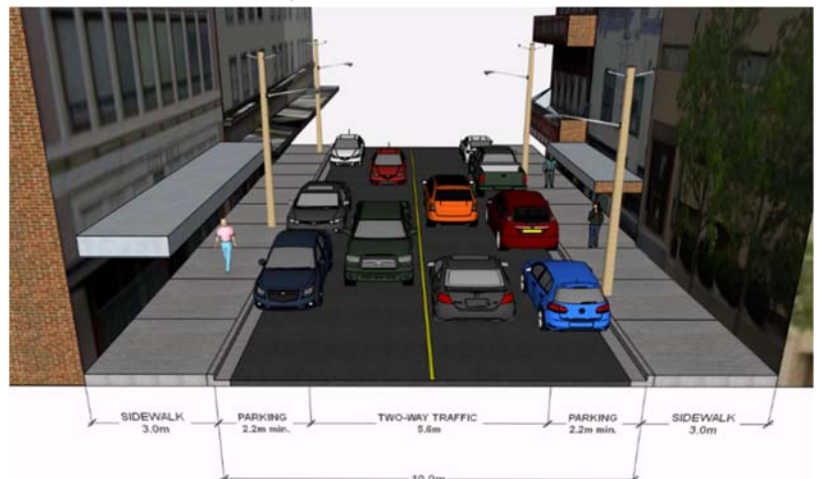

Figure 4-1 - Gottingen Street Typical Cross Section Looking South
Buddy Daye Street to Falkland Street



Figure 4-2 - Google Traffic Map - 5:00 PM, Wednesday, July 19, 2017

4.1.1 EXISTING TRANSIT

Gottingen Street is a very busy transit corridor for Halifax Transit, particularly during the PM peak period. It is currently used by 18 Halifax Transit Routes (#1, 7, 10, 11, 21, 31, 33, 34, 41, 53, 59, 61, 68, 86, 159, 320, 330, and 370). Transit vehicle volume and ridership data were collected by Halifax Transit and are summarized in Table 4-1.

Table 4-1 - Existing Transit Volumes and Ridership along Existing Routes

		Transit Vehicles	Transit Riders
AM Peak Hour	Southbound	15	770
	Northbound	25	200
PM Peak Hour	Southbound	4	50
	Northbound	56	1600

4.1.2 EXISTING TRAFFIC

Turning movement counts at the Gottingen Street intersections with North Street, Cornwallis Street, and Cogswell Street were collected by HRM Traffic Management for the morning (7-9 AM) and afternoon (4-6 PM) peak periods. The AM and PM design hour volumes are summarized in Figure 4-3. Traffic analysis of existing conditions was prepared using *Synchro 9* and is summarized in Appendix F.

Additional pedestrian volume data were provided by HRM Traffic Management for the existing crosswalks at Charles Street, Uniacke Street, Buddy Daye Street, and Cunard Street. No pedestrian volume data were available for the marked crosswalk at Falkland Street.

4.1.3 EXISTING MULTIMODAL ANALYSIS

Using available traffic, pedestrian, and bicycle count data from HRM Traffic Management and the geometric configuration of the existing sidewalk and lane layouts, the pedestrian and bicycle multi-modal level of service for the key intersections and corridor segments were determined.

Analysis finds that the segment MMLOS for pedestrians is 'C' or 'D' and for bicyclists is 'D' in each of the AM and PM peak hours.

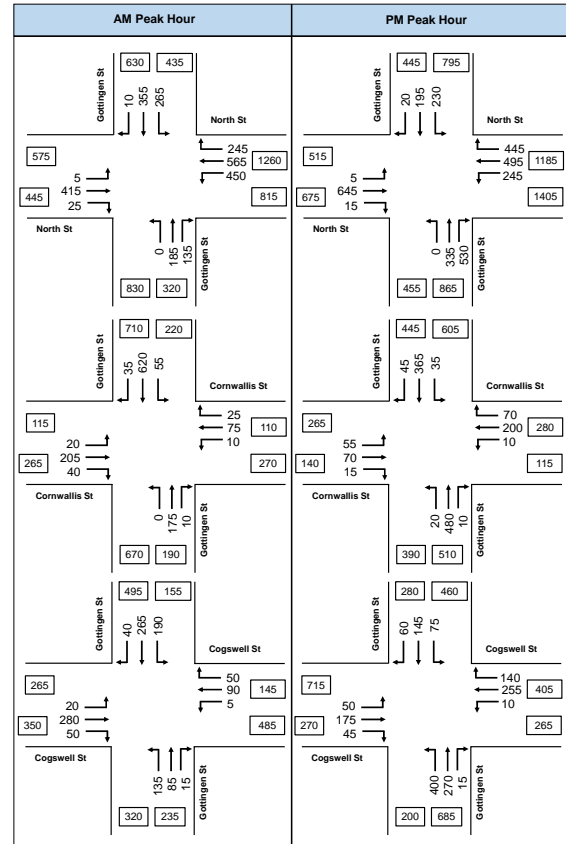

Figure 4-3 - Gottingen St Corridor AM and PM design hour traffic volumes

4.1.4 ROAD SAFETY

Available data for collisions occurring within the Gottingen Street study area in 2015 and 2016 were provided by the Halifax Regional Police and reviewed to consider if any mitigative measures could be identified. The available collision reports indicate that of the 31 reported study area collisions with available information, approximately 40% (12) involved a parked vehicle. No other trends were identified.

4.1.5 EXISTING PARKING



During the day, parking is permitted on Gottingen Street as shown in Figure 4-4. Additional no stopping restrictions are in place on the east (northbound) side between 4-6 PM.



Figure 4-4 - Existing Parking on Gottingen Street

4.2 GOTTINGEN STREET MODIFICATION OPTIONS

Three modification options were prepared for the Gottingen Street study area and are summarized below. Functional design plans for each option are included in Appendix A and cost estimates are included in Appendix D.

Option	Description
<p data-bbox="207 556 228 730" style="writing-mode: vertical-rl; transform: rotate(180deg);">High Investment</p> <p data-bbox="250 401 670 426">Option G1 – Continuous NB Transit Lane</p>  <p data-bbox="250 730 581 756">*Proposed cross section looking south</p>	<ul data-bbox="943 401 1516 541" style="list-style-type: none"> • Remove parking/loading from Gottingen Street; • Provide a continuous northbound right turn lane (except buses); and, • Install Pedestrian Half-Signals at Key Pedestrian Crossings. <p data-bbox="894 548 980 573"><u>Impacts:</u></p> <ul data-bbox="943 579 1516 884" style="list-style-type: none"> • Provides a continuous transit lane in the critical northbound direction. • Removal of parking and separation of northbound buses is expected to improve flow of traffic along the corridor. • Positive for safety due to noted collision trend and less need to cross centre line to get around parked vehicles. • Analysis (Appendix F) indicates minimal impact to non-transit vehicles while providing significant transit benefit.
<p data-bbox="207 1045 228 1220" style="writing-mode: vertical-rl; transform: rotate(180deg);">Medium Investment</p> <p data-bbox="250 896 792 921">Option G2 – NB Transit Priority at Key Intersections</p>  <p data-bbox="250 1222 800 1247">*Proposed cross section looking south at key intersections only</p>	<ul data-bbox="943 896 1516 1066" style="list-style-type: none"> • Remove parking/loading from Gottingen Street during peak periods; • Provide transit queue jump lanes at key locations; and, • Install Pedestrian Half-Signals at Key Pedestrian Crossings <p data-bbox="894 1073 980 1098"><u>Impacts:</u></p> <ul data-bbox="943 1104 1516 1402" style="list-style-type: none"> • Provides transit priority measures at key locations while having minimal impact on parking/loading during offpeak periods. • Improved flow of traffic along the corridor is expected during peak periods. • Positive for safety due to noted collision trend and less need to cross centre line to get around parked vehicles. • Analysis at the Cornwallis Street intersection (Appendix F) indicates minimal impact to non-transit vehicles while providing transit benefit.
<p data-bbox="207 1501 228 1675" style="writing-mode: vertical-rl; transform: rotate(180deg);">Low Investment</p> <p data-bbox="250 1415 678 1440">Option G3 – Remove Peak Period Parking</p>  <p data-bbox="250 1713 581 1738">*Proposed cross section looking south</p>	<p data-bbox="894 1472 980 1497"><u>Impacts:</u></p> <ul data-bbox="943 1503 1516 1696" style="list-style-type: none"> • Does not specifically provide transit priority. • Minor improvements to flow of traffic (and transit) along the corridor considering current restriction already in place during PM peak for northbound. • Positive for safety due to noted collision trend and less need to cross centre line to get around parked vehicles.

4.3 GOTTINGEN STREET OPTIONS EVALUATION

Using the available data, traffic flow models were created using SimTraffic to develop estimates for changes in user delay with each option. Table 4-2 summarizes the benefits to transit and non-transit users and the estimated implementation costs (See Appendix D).

An options evaluation matrix was created in order to display the overall assessment of each option and enable comparison between categories (See Table 4-3). As presented, the evaluation matrix is a visual tool that enables high level options comparison.

Table 4-2 - Gottingen Street - Overall Corridor Options Summary

Corridor Segment	G1 - Continuous NB Transit Lane	G2 - Transit Priority at Key Intersections	G3 - Remove Parking
Total Estimated Annual Operating Cost Savings to Halifax Transit	\$36,625	\$8,610	\$3,340
Total Estimated Daily Reduction in Transit User Delay	65 hrs	15 hrs	5 hrs
Total Estimated Daily Reduction in Overall User Delay	70 hrs	20 hrs	10 hrs
Total Estimated Implementation Cost	\$0.25 Million	\$0.22 Million	Negligible Cost (Signage Only)

Table 4-3 Gottingen Street Options Evaluation Summary Matrix

		Transit Corridor Options			
		Existing Conditions	G1. Continuous NB Lane	G2. NB Transit Priority - Key Locations	G3. Parking / Loading Modifications
User Experience	Transit Travel Time	Orange	Green	Yellow	Orange
	Transit Schedule Reliability	Red	Green	Green	Orange
	Transit Visibility	Red	Green	Green	Red
	Walking	Green	Green	Green	Green
	Bicycling	Yellow	Orange	Yellow	Green
	MMLOS	Yellow	Orange	Yellow	Yellow
	Road Safety	Yellow	Green	Green	Green
Impacts	Traffic Impacts	Grey	Green	Green	Green
	Loading/Parking Impacts	Grey	Red	Orange	Orange
	Implementation Cost	Grey	Green	Green	Green
Public Support	Public Feedback Response	Grey	Green	Green	Yellow

Most Desirable / Least Difficult Least Desirable / Most Difficult

Note: Grey indicates not applicable or not available

Note: There is no anticipated impact to the right of way width or available space for green space / urban forest.

Each option for the full corridor was evaluated using the payback period analysis methodology included in *Moving Forward Together Plan* (Halifax Transit, 2016) and summarized in Section 3.3.1. The methodology is included in Appendix E with results summarized in Table 4-4.

Table 4-4 - Overall Payback Period Analysis – Gottingen Street

		Gottingen Street		
		G1- Continuous Northbound Transit Lane	G2- NB Transit Priority at Key Intersections	G3- Remove Peak Period Parking; No Specific Transit Priority
Estimated Daily Delay Savings to Transit Users		~65 pass.hr	-15 pass.hr	~5 pass.hr
Estimated Daily Delay Savings to All Road Users		~70 pass.hr 5	~20 pass.hr 4	~10 pass.hr 3
Payback Period		0.6 years 5	2.0 years 4	N/A 5
Other Key Factors	Score for Other Factors ¹	3	1	0
	Safety Considerations	(+)Improved flow through network and reduced parking manoeuvres		
	Impact to Other Users	(-)Loss of Parking Half signal for pedestrians may improve pedestrian safety but increase pedestrian delay		(-)Loss of Parking
	Project Integration	None identified		
	TPM Enforcement Requirements	Enforcement of typical signage required		None
	Issues to Implementation	None		
	Promotion of Transit	(+)Good Promotion of Transit	Some Promotion of Transit	None
Schedule Adherence	(++)Greatly improved schedule adherence	(+)Improved schedule adherence	(+)Some improvements may be realized	
Public Consultation	(++)Generally viewed as the best option overall	(+)Viewed as a good option	Generally seen as the least desirable option overall	
Stakeholder Consultation	(--)Concern for parking/loading	(-)Loss of SB parking during peak periods		
Overall Evaluation	13	9	8	
NOTES: 1. Score for other factors is the sum of the positive impacts less the negative impacts. Impacts with "++" or "--" received double score.				

Comparative evaluation of the user impacts (Table 4-3) and payback analysis (Table 4-4) indicates that greater overall benefit is expected with Option G1 (Continuous northbound transit lane) and this option should be considered for implementation by HRM.

This Space Intentionally Left Blank

5 BAYERS ROAD

5.1 EXISTING CONDITIONS

Bayers Road between Romans Avenue and Windsor Street (approximately 1.4 km) is an arterial roadway. In this area the roadway transitions from a four lane cross section near Romans Avenue (See Figure 5-2) to seven lanes around the Halifax Shopping Centre (HSC) and reduces to a three lane section plus parking east of Connaught Avenue (See Figure 5-1). Traffic data obtained by HRM Traffic Management indicate a weekday two-way traffic volume of between 15,000 and 45,000 vehicles per day (vpd).



Figure 5-2 - Typical Cross Section Looking East-Bayers Road near Romans Avenue

Significant congestion has been observed along this corridor, particularly during the peak periods when inbound traffic in the morning has been observed to back up onto Highway 102 while outbound traffic congestion during the afternoon peak has been observed to extend through the entire corridor. Travel times in the outbound direction between Oxford Street and Connaught Avenue during the PM peak period have been observed to exceed 15 minutes, indicating severe congestion in this area and contributes to shortcutting onto local streets (shown in Figure 5-3).

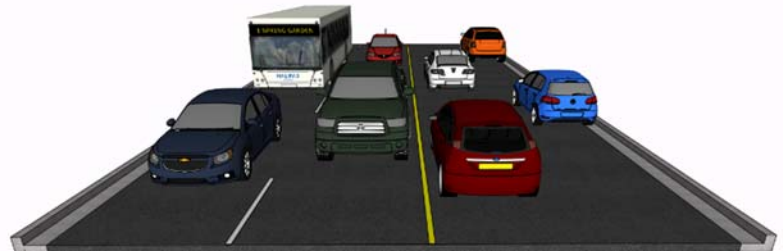

Figure 5-1 - Typical Cross Section Looking East-Connaught Avenue to Windsor Street

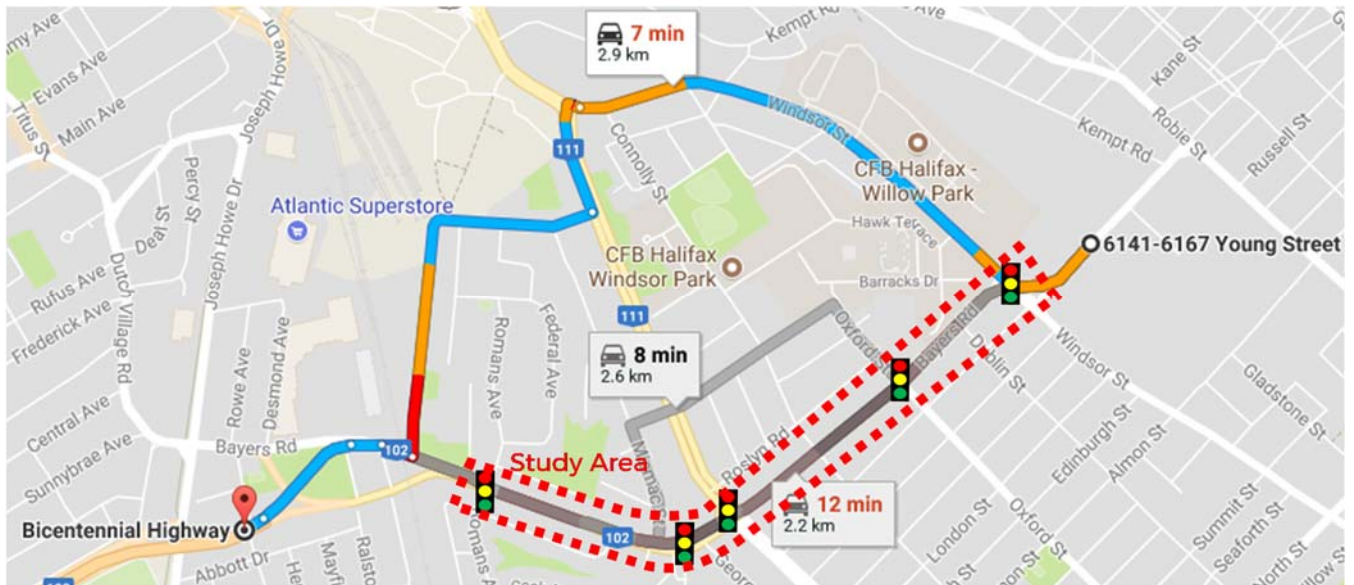

Figure 5-3 - Google Traffic Map - 4:30 PM, Tuesday, October 17, 2017
(Travel time through the uncongested corridor is approximately 4 minutes)

5.1.1 EXISTING TRANSIT

Bayers Road is currently used by 7 Halifax Transit Routes (#1, 2, 9, 17, 80, 81, and 330, See Figure 5-4). Transit ridership data were collected by Halifax Transit and indicate that at the Connaught Avenue intersection there are estimated to be:

- 37 two-way buses carrying 700 transit riders in the AM peak hour; and,
- 35 two-way two way buses carrying 730 transit riders in the PM peak hour.

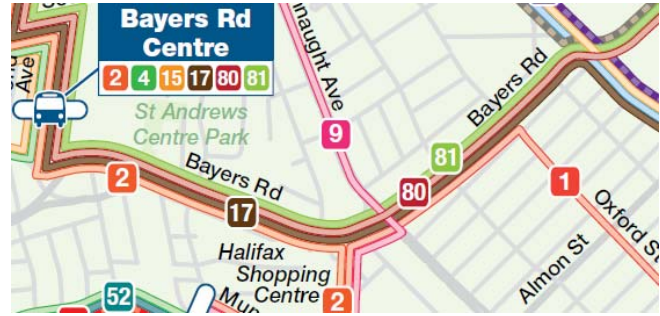

Figure 5-4 - Halifax Transit Routes on Bayers Road

5.1.2 EXISTING TRAFFIC

Turning movement counts at the Bayers Road intersections with Romans Avenue, Halifax Shopping Centre (HSC), Connaught Avenue, Oxford Street, and Windsor Street were collected by HRM Traffic Management for the morning (7-9 AM) and afternoon (4-6 PM) peak periods. AM and PM Design Hourly Volumes for the Romans, HSC, Connaught, and Windsor intersections are summarized in Figure 5-5. Traffic analysis of existing conditions was prepared using *Synchro 9* and is summarized in Appendix G.

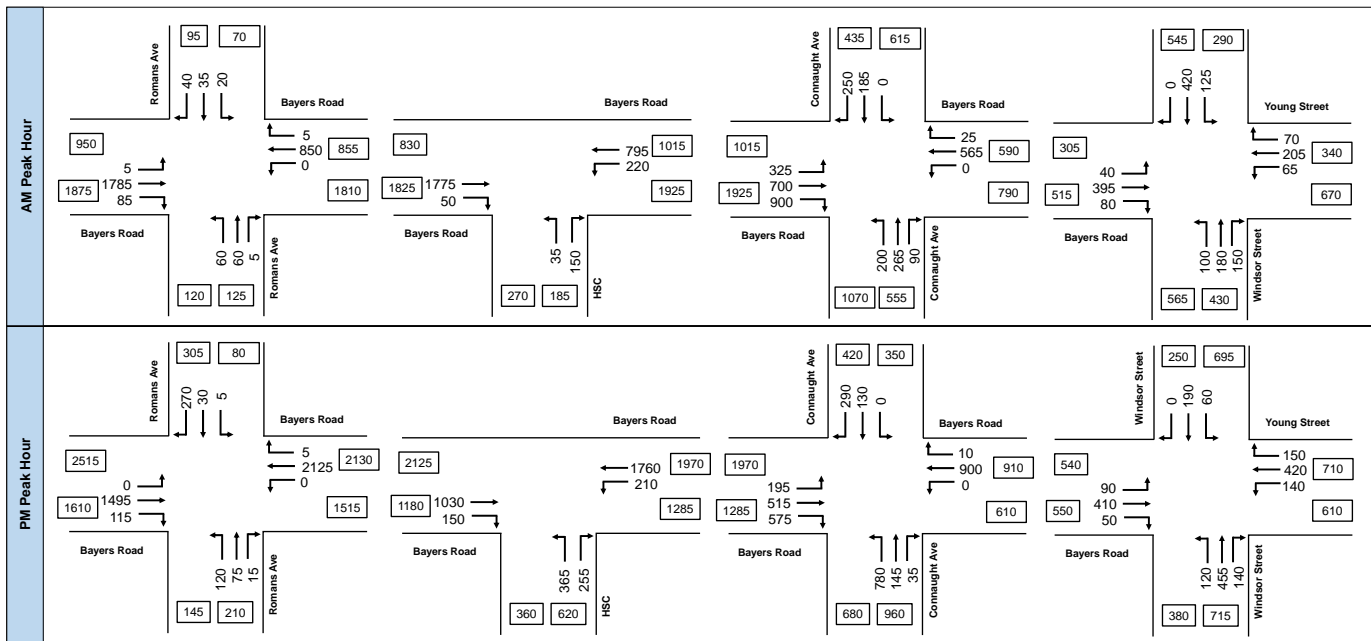

Figure 5-5 - Bayers Road Corridor AM and PM Design Hourly Traffic Volumes

5.1.3 EXISTING MULTIMODAL ANALYSIS

Using available traffic, pedestrian, and bicycle count data from HRM Traffic Management and the geometric configuration of the existing and proposed sidewalk and lane layouts, the pedestrian and bicycle multi-modal level of service for the corridor segments were estimated (See Section 3.3.2).

	Romans Avenue to Connaught Avenue	Connaught Avenue to Windsor Street
Existing Bicycle MMLOS	With high traffic volumes and no designated bicycle facilities the existing segment bicycle MMLOS is overall 'E' in both directions during the AM and PM peak hours.	With lower traffic volumes but still no designated bicycle facilities the existing segment bicycle MMLOS is overall 'D' or 'E' during the AM and PM peak hours.
Existing Pedestrian MMLOS	With high traffic volumes and sidewalk near the roadway, segment pedestrian MMLOS is overall 'D' or 'E' for both sides during the AM and PM peak hours.	With lower traffic volumes and sidewalk near the roadway, segment pedestrian MMLOS is overall 'D' for both sides during the AM and PM peak hours.

5.1.4 ROAD SAFETY

Collision reports were not available for this corridor for collision analysis. A comparative analysis between the options for this corridor considered how each option changed the number or type of conflict points.

5.1.5 EXISTING PARKING

Parking is generally restricted along this corridor with the following exceptions:

- The south side between Connolly Street and east of Dublin Street is time restricted with some unrestricted parking; and,
- The north side between Oxford Street and west of Connolly Street is signed as no stopping during the PM peak period and is otherwise unrestricted.

5.2 BAYERS ROAD MODIFICATION OPTIONS

With the changing road width and varying traffic volumes along Bayers Road, this corridor has been separated into four segments for the development and evaluation of transit priority options. The four road segments are identified in Figure 5-6.

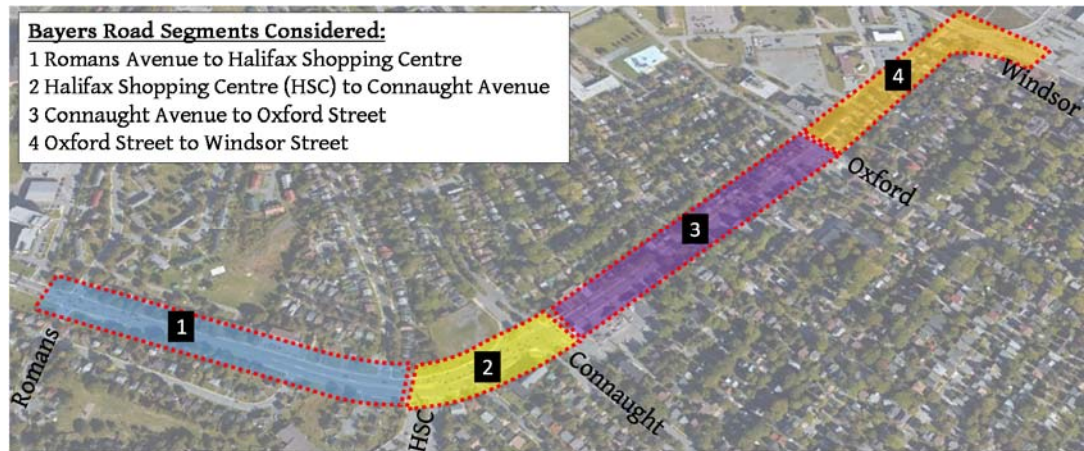

Figure 5-6 - Bayers Road Segments Considered in this Study

Recognizing the congestion, the high traffic volumes, the importance of this

corridor as a truck and traffic route to and from Peninsular Halifax, and the priorities for allocation of street space, options have been prepared for each of the segments of this corridor. These options for each segment are shown conceptually in Appendix A and described in subsequent sections of this report.

Lane Requirements:

At the outset of the project, traffic analysis was prepared to assess the lane requirements for each segment of the corridor. Analysis considered whether reductions to one through lane in each direction for non-transit could accommodate the traffic volumes without causing significant negative impact to non-transit vehicle operations.

Intersection analysis results (See Appendix G) indicate that the operations of the intersections in segments #1 and #2 (Figure 5-6) approach or exceed capacity with two through lanes for non-transit with existing volumes and lane configurations. Analysis indicates that while traffic in segments #3 and #4 could be accommodated by a single through lane in each direction, reduction to a single lane in each direction is expected to significantly impact capacity for non-transit vehicles in segments #1 and #2. Since no eastbound transit lane is proposed west of the study area, this increased congestion of non-transit vehicles is expected to impact eastbound transit movements as they approach the study area.

Traffic analysis results indicate that:

- **Two non-transit lanes** in each direction should be provided along segments #1 and #2; and,
- **One non-transit lane** in each direction along segments #3 and #4 is expected to accommodate the non-transit volumes.



Proposed AT Greenway Cost Estimates:

Although cost estimates include the installation of the proposed AT greenway between Romans and George Dauphinee, the installation of the greenway is not considered integral to the provision of transit priority along this corridor and has not been included in the cost-benefit analysis of the transit options.

It is estimated that the total installation cost (excluding property acquisition and HST) of the proposed AT greenway between Romans Avenue and George Dauphinee Avenue is approximately \$335,000 and is not contingent on which roadway option is selected.

5.2.1 ROMANS AVENUE TO HALIFAX SHOPPING CENTRE

This segment of Bayers Road has two through lanes in each direction and experiences very heavy through volumes during the AM and PM peak periods. Two modification options (plans included in Appendix A) were prepared for this segment and are summarized below. Intersection analysis is included in Appendix G.

Option		Description
High Investment	1 – Widen to Install Continuous EB and WB Transit Lanes 	<ul style="list-style-type: none"> Widen on south side to provide a continuous eastbound and westbound transit lanes; and, Install offstreet active transportation greenway. <p><u>Impacts:</u></p> <ul style="list-style-type: none"> Requires some property acquisition on south side of Bayers Road. Provides a full-time continuous transit lane in both directions. Removes transit vehicles and right turns from flow of non-transit vehicles Provides offstreet active transportation greenway
Medium Investment	2 – Widen to Install Reversible Lane and designate transit lane in peak direction 	<ul style="list-style-type: none"> Widen on southside to provide a continuous eastbound transit lane in the AM peak period and westbound transit lane in the PM peak period; Install reversible lane signage (similar to Chebucto Road, Macdonald Bridge); and, Install offstreet active transportation greenway. <p><u>Impacts:</u></p> <ul style="list-style-type: none"> Requires some property acquisition on south side of Bayers Road. Provides a full-time continuous transit lane in peak direction. Removes transit vehicles and right turns from flow of non-transit vehicles in peak direction. Provides offstreet active transportation greenway. Negative safety impact with reversible lane and complicated time of day transit lane signage.

An options evaluation matrix was created in order to display the overall assessment of each option and enable comparison between categories (See Table 5-1).

Table 5-1 – Bayers Road – Romans Avenue to Coleman Court Options Evaluation Summary Matrix

		Transit Corridor Options		
		Existing Conditions	1. Continuous Transit Lanes	Opt 2. Reversible Lane
User Experience	Transit Travel Time	Red	Green	Green
	Transit Schedule Reliability	Red	Green	Orange
	Transit Visibility	Red	Green	Yellow
	Walking	Orange	Yellow	Yellow
	Bicycling	Red	Green	Green
	MMLoS	Orange	Green	Green
	Road Safety	Yellow	Green	Red
Impacts	Traffic Impacts	Grey	Green	Yellow
	Property Requirements	Grey	Orange	Orange
	Green space / Urban Forest	Grey	Orange	Yellow
	Implementation Cost	Grey	Orange	Orange
Public Support	Public Feedback Response	Grey	Green	Yellow



Most Desirable / Least Difficult ← → Least Desirable / Most Difficult

Note: Grey indicates not applicable or not available

Note: Parking is already restricted and there is no proposed change to parking.

5.2.2 HALIFAX SHOPPING CENTRE (HSC) TO CONNAUGHT AVENUE

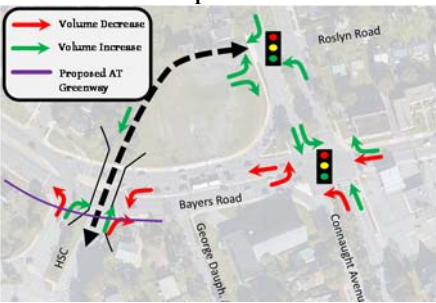
With approximately 100 metres between the Connaught and HSC (east) intersection, queuing and lane changes by turning traffic are frequently observed. Modification options (plans included in Appendix A) were prepared for this segment and are summarized below. Intersection analysis is included in Appendix G.

Option	Description
<p style="writing-mode: vertical-rl; transform: rotate(180deg);">High Investment</p>	<p>1 – Construct Overpass To HSC</p>  <ul style="list-style-type: none"> Reprofile Bayers Road and Connaught Avenue to install grade separation over Bayers Road for connection to HSC; Remove traffic signals from HSC intersections; Install traffic signals at Connaught Avenue / Roslyn Road intersection; Modify HSC (west) driveway to become right-in, right-out only; and, Install offstreet active transportation greenway. <p><u>Impacts:</u></p> <ul style="list-style-type: none"> Requires property acquisition. Impacts access to HSC. Impacts grades on Bayers Road and access to adjacent properties. Expected to significantly improve traffic flow. Reduced merging manoeuvres are expected to provide significant safety improvement. Removes signalized crossing for AT greenway through this segment. Expected to create significant disruption during construction.
<p style="writing-mode: vertical-rl; transform: rotate(180deg);">Medium Investment</p>	<p>2A – Construct new roadway to HSC</p>  <ul style="list-style-type: none"> Construct a driveway connecting Connaught Avenue opposite Roslyn Road to Halifax Shopping Centre; Restrict left turns from Bayers Road to Halifax Shopping Centre; and, Install offstreet active transportation greenway. <p><u>Impacts:</u></p> <ul style="list-style-type: none"> Requires property acquisition. Impacts access to HSC. Expected to improve traffic flow. Reduced merging manoeuvres expected to provide safety improvement. Analysis (Appendix G) indicates benefit to transit and non-transit. <p>2B – Construct new transit-only roadway to HSC</p> <p>(Option developed following Public Consultation)</p> <ul style="list-style-type: none"> Similar to Option 2A, a roadway could be constructed that would allow transit vehicles to access HSC and allow right turns onto Bayers Road into a transit only lane. This would allow outbound transit vehicles to bypass congestion in this segment without changing access to HSC. <p><u>Impacts:</u></p> <ul style="list-style-type: none"> Requires property acquisition. No safety benefit of reduced merging / diverging of turning traffic to HSC. Requires installation of a receiving lane for transit vehicles on private property. May complicate operations on HSC property.
<p style="writing-mode: vertical-rl; transform: rotate(180deg);">Low Investment</p>	<p>3 – Widen to provide transit lanes</p> <ul style="list-style-type: none"> Widen to construct transit lanes; and, Install offstreet active transportation greenway. <p><u>Impacts:</u></p> <ul style="list-style-type: none"> Requires property acquisition. Widens already wide roadway and extends pedestrian crossing distance. Little impact on traffic flow.

An options evaluation matrix was created in order to display the overall assessment of each option and enable comparison between categories (See Table 5-2).

Table 5-2 – Bayers Road – Coleman Court to Connaught Avenue Options Evaluation Summary Matrix



		Transit Corridor Options				
		Existing Conditions	Opt 1. Overpass to HSC	Opt 2A. Realigned HSC	Opt 2B. Transit only roadway	Opt 3. Widen to Install Transit Lanes
User Experience	Transit Travel Time	Red	Green	Light Green	Light Green	Yellow
	Transit Schedule Reliability	Red	Green	Light Green	Light Green	Light Green
	Transit Visibility	Red	Light Green	Light Green	Light Green	Light Green
	Walking	Orange	Light Green	Yellow	Yellow	Orange
	Bicycling	Red	Green	Light Green	Light Green	Light Green
	MMLOS	Orange	Light Green	Light Green	Light Green	Yellow
	Road Safety	Orange	Light Green	Yellow	Yellow	Orange
Impacts	Traffic Impacts	Grey	Green	Light Green	Yellow	Yellow
	Property Requirements	Grey	Red	Orange	Orange	Orange
	Green space / Urban Forest	Grey	Yellow	Yellow	Yellow	Yellow
	Implementation Cost	Grey	Red	Yellow	Yellow	Yellow
Public Support	Public Feedback Response	Grey	Green	Light Green	Grey	Yellow

Most Desirable / Least Difficult  Least Desirable / Most Difficult
 Note: Grey indicates not applicable or not available

Notes: Parking is already restricted and there is no proposed change to parking.
 Public input is not available for Option 2B.

5.2.3 CONNAUGHT AVENUE TO WINDSOR STREET

Traffic volumes collected by HRM indicate that peak period through volumes along this section are generally around 500-700 vehicles per direction. Three modification options (plans included in Appendix A) were prepared for this segment and are summarized below. Intersection analysis is included in Appendix G.

Option	Description
<p>High Investment</p> <p>1 - Install EB and WB transit lanes</p> 	<ul style="list-style-type: none"> Widen to provide a continuous eastbound and westbound transit lane; and, Remove parking. <p><u>Impacts:</u></p> <ul style="list-style-type: none"> Requires some property acquisition along the full corridor. Removes parking. Slight negative impact to westbound non-transit vehicles. Provides a full-time continuous transit lane in both directions. Removes transit vehicles and right turns from traffic flow.
<p>Medium Investment</p> <p>2 - Install reversible lane and designate transit lane in peak direction</p> 	<ul style="list-style-type: none"> Provide a continuous eastbound transit lane in the AM peak period and westbound transit lane in the PM peak period; Install reversible lane signage (similar to Chebucto Road, Macdonald Bridge); and, Remove parking. <p><u>Impacts:</u></p> <ul style="list-style-type: none"> Requires some property acquisition around Connaught Avenue and Oxford Street. Removes parking. Slight negative impact to westbound non-transit vehicles. Provides a full-time continuous transit lane in peak directions. Removes transit vehicles and right turns from traffic flow in peak direction. Negative safety impact with reversible lane and complicated time of day transit lane signage.
<p>Low Investment</p> <p>3 - Install WB transit lane</p> 	<ul style="list-style-type: none"> Provide a continuous westbound transit lane; and Remove parking in westbound direction. <p><u>Impacts:</u></p> <ul style="list-style-type: none"> Requires some property acquisition around Connaught Avenue. Removes some parking from north side. Slight negative impact to westbound non-transit vehicles. Provides some transit priority in westbound direction only.

An options evaluation matrix was created in order to display the overall assessment of each option and enable comparison between categories (See Table 5-3).

Table 5-3 – Bayers Road –Connaught Avenue to Windsor Street Options Evaluation Summary Matrix

		Transit Corridor Options			
		Existing Conditions	1. Continuous transit lanes both directions	2. Reversible lane	3. Transit Lane WB
User Experience	Transit Travel Time	Red	Green	Light Green	Yellow
	Transit Schedule Reliability	Red	Green	Light Green	Light Green
	Transit Visibility	Red	Green	Light Green	Light Green
	Walking	Yellow	Yellow	Yellow	Yellow
	Bicycling	Orange	Orange	Orange	Orange
	MMLOS	Orange	Orange	Orange	Orange
	Road Safety	Orange	Light Green	Orange	Light Green
Impacts	Traffic Impacts	Grey	Yellow	Yellow	Yellow
	Property Requirements	Grey	Orange	Yellow	Yellow
	Loading/Parking Impacts	Grey	Red	Red	Orange
	Green space / Urban Forest	Grey	Orange	Yellow	Yellow
	Implementation Cost	Grey	Yellow	Yellow	Light Green
Public Support	Public Feedback Response	Grey	Green	Light Green	Yellow

Most Desirable / Least Difficult
Least Desirable / Most Difficult



Note: Grey indicates not applicable or not available

5.2.4 WINDSOR STREET INTERSECTION

This intersection experiences awkward lane alignment and intersection geometry. Although roundabout configurations were considered, they were excluded due to significant property impacts and challenging signage requirements. Two modification options (plans included in Appendix A) were prepared for this intersection and are summarized below. Intersection analysis is included in Appendix G.

Option	Description
1 – Modify right turn channels and install EB and WB transit lanes	<ul style="list-style-type: none"> Modify alignment of right turn channels from Windsor Street to Bayers Road and Young Street; Designate a westbound lane as right turn only (except buses); and, Widen to install an eastbound right turn lane (except buses). <u>Impacts:</u> <ul style="list-style-type: none"> Requires some property acquisition Provides a full-time continuous transit lane in both directions. Removes transit vehicles and right turns from traffic flow.
2 – Install WB transit lane	<ul style="list-style-type: none"> Provide a continuous westbound transit lane; and, <u>Impact:</u> <ul style="list-style-type: none"> Provides transit priority in westbound direction.

An options evaluation matrix was created in order to display the overall assessment of each option and enable comparison between categories (See Table 5-4).

Table 5-4 – Bayers Road at Windsor Street Intersection Options Evaluation Summary Matrix

		Transit Corridor Options		
		Existing Conditions	1. Continuous transit lanes both directions	2. Transit Lane WB
User Experience	Transit Travel Time	Orange	Green	Yellow
	Transit Schedule Reliability	Orange	Green	Light Green
	Transit Visibility	Orange	Green	Light Green
	Walking	Orange	Light Green	Yellow
	Bicycling	Orange	Yellow	Orange
	MMLOS	Orange	Yellow	Orange
	Road Safety	Orange	Light Green	Yellow
Impacts	Traffic Impacts	Grey	Yellow	Yellow
	Property Requirements	Grey	Orange	Yellow
	Green space / Urban Forest	Grey	Light Green	Yellow
	Implementation Cost	Grey	Orange	Yellow
Public Support	Public Feedback Response	Grey	Green	Yellow



Note: Grey indicates not applicable or not available

Note: Parking at the intersection is not permitted and there is no proposed change to parking

5.3 BAYERS OPTIONS EVALUATION

In performing the overall analysis and evaluation for the full corridor it is recognized that the impacts of implementing a particular option in one segment may impact the operations in another segment. Several options (summarized in Table 5-5) were considered for the purpose of evaluating the measures along the full corridor.

Table 5-5 - Bayers Road – Overall Corridor Options Summary

		Transit Corridor Option - Bayers Road					
		B1.1 - High Investment Full Corridor	B1.2A - High Investment Med at HSC	B1.2B - High Investment Med (Transit Only) at HSC	B1.3 - High Investment Low at HSC	B2 - Medium Investment Full Corridor	B3 - Low Investment Full Corridor
Corridor Segment	Romans to HSC	Opt 1 (Continuous lanes each direction)				Opt 2: (Reversible Lane)	
	HSC to Connaught	Opt 1 (Overpass)	Opt 2A (Construct new roadway)	Opt 2B (Construct new transit roadway)	Opt 3 (Install transit lanes in both directions)	Opt 2A (Construct new roadway)	Opt 3 (Install transit lanes in both directions)
	Connaught to Windsor	Opt 1 (Continuous lanes each direction)				Opt 2 (Reversible Lane)	Opt 3 (Transit lane westbound only)
	Windsor Street Intersection	Opt 1 (Continuous lanes each direction)				Opt 2 (Modify RT channels and install EB and WB transit lanes)	
Estimated Results	Total Estimated Annual Operating Cost Savings to Halifax Transit	\$71,150	\$44,120	\$44,120	\$29,800	\$36,055	\$19,770
	Total Estimated Daily Reduction in Transit User Delay	100 hrs	60 hrs	60 hrs	40 hrs	50 hrs	25 hrs
	Total Estimated Daily Reduction in Overall User Delay	310 hrs	140 hrs	60 hrs	50 hrs	130 hrs	35 hrs
	Total Estimated Implementation Cost	\$15.9 Million	\$4.8 Million	\$4.8 Million ¹	\$3.3 Million	\$4.6 Million	\$2.1 Million
Note:	1. Cost estimates for the implementation of HSC option 2B (medium, transit only) have not specifically been prepared, however, it is expected to be similar to cost estimates to implement option 2A in that segment.						

An options evaluation matrix was created in order to display the overall assessment of each option and enable comparison between categories (See Table 5-6). Each option for the full corridor was evaluated using the payback period analysis methodology (See Appendix E) included in Moving Forward Together Plan (Halifax Transit, 2016) and as described in Section 3.3.1 with results summarized in Table 5-7.

Table 5-6 - Bayers Road – Overall Corridor Options Evaluation Summary Matrix

		Existing Conditions	Transit Corridor Options				
			B1.1 High Investment	B1.2A High with Med at HSC	B1.2B High with Med (Transit Only) at HSC	B1.3 High with Low at HSC	B2. Medium Investment
User Experience	Transit Travel Time	Red	Green	Green	Green	Yellow	Yellow
	Transit Schedule Reliability	Red	Green	Green	Green	Green	Orange
	Transit Viability	Red	Green	Green	Green	Green	Yellow
	Walking	Orange	Green	Green	Green	Green	Yellow
	Bicycling	Red	Green	Green	Green	Green	Yellow
	MMLLOS	Orange	Green	Green	Green	Green	Yellow
Impacts	Road Safety	Orange	Green	Green	Green	Orange	Yellow
	Traffic Impacts	Grey	Green	Green	Green	Green	Yellow
	Property Requirements	Grey	Orange	Yellow	Yellow	Green	Green
	Green space / Urban Forest	Grey	Orange	Yellow	Yellow	Orange	Yellow
Public Support	Loading/Parking Impacts	Grey	Orange	Yellow	Yellow	Orange	Yellow
	Implementation Cost	Grey	Red	Orange	Yellow	Orange	Yellow
Public Support	Public Feedback Response	Grey	Green	Green	Green	Yellow	Orange

Note: Grey indicates not applicable or not available

Comparative evaluation of the user impacts (Table 5-6) and payback analysis (Table 5-7) indicate that although significant delay savings are anticipated with Option B1.1 (High Investment), after consideration of cost, property impacts, and urban form, the best overall option is expected to be Option B1.2A (High Investment, Medium through HSC segment) which offers a strong mix for all users and this option should be considered for implementation by HRM.

Table 5-7 – Bayers Road Corridor Options - Payback Period Analysis

		Bayers Road					
		B1.1-High Investment Full Corridor	B1.2A-High Investment Medium at HSC	B1.2B-High Investment Medium (Transit Only) at HSC ²	B1.3-High Investment Low at HSC	B2- Medium Investment	B3-Low Investment
Estimated Daily Delay Savings to Transit Users		~100 pass.hr	~60 pass.hr	~60 pass.hr	~40 pass.hr	~50 pass hr	~25 pass.hr
Estimated Daily Delay Savings to All Road Users		~310 pass.hr 5	~140 pass.hr 4	~70 pass.hr 3	~50 pass.hr 3	~130 pass hr 4	~35 pass.hr 3
Payback Period to Public		9.0 years 4	6.1 years 5	13.3 years 3	14.4 years 3	6.2 years 5	10.0 years 4
Score for Other Factors ¹		5	5	6	4	1	1
Safety Considerations		(-)Grade separation removes merging and crossing conflicts	Reduced congestion may provide improvement	Reduced congestion may provide improvement	Separation of buses from through movement may provide some improvement	(-)Reversible lane may not be understood by all drivers Reduced congestion may provide improvement	Separation of buses from through movement may provide some improvement
Impact to Other Users		(+)Provides grade separated crossings for AT users (+)Significant improvements for emergency vehicles	(+)Improvements for emergency vehicles	(+)Improvements for emergency vehicles	(+)Some improvements for emergency vehicles	(+)Improvements for emergency vehicles	(+)Some improvements for emergency vehicles
Project Integration		Opportunity to integrate with new AT greenway between Romans and George Dauphinee					
TPM Enforcement Requirements		No Specific Requirements Identified					
Issues to Implementation		(-)Property acquisition required along full corridor (-)Impacts to access for HSC and other properties (-)Grading challenges through HSC segment	(-)Property acquisition required along full corridor (-)Impacts to access for HSC	(-)Property acquisition required along full corridor	(-)Property acquisition required along full corridor	(-)Property acquisition required along full corridor (-)Impacts to access for HSC	(-)Property acquisition required along a portion of the corridor
Promotion of Transit		(++)Excellent promotion of transit	(++)Excellent promotion of transit	(++)Excellent promotion of transit	(++)Excellent promotion of transit	(+)Good Promotion of Transit	Some Promotion of Transit
Schedule Adherence		(++)Greatly improved Schedule adherence in both directions	(++)Greatly improved Schedule adherence in both directions	(++)Greatly improved Schedule adherence in both directions	(+)Improved Schedule adherence in both directions	(+)Improved Schedule adherence, mostly in peak directions	(+)Some improved Schedule adherence at key intersections
Public Consultation		(++)Generally seen as the best option by the public	(++)Seen as a good option by the public overall	(++)Seen as a good option by the public overall	(+)Considered a good option	(+)Seen as a good option by the public	Generally perceived to be the least desirable option
Overall Evaluation		14	14	12	10	10	8

NOTES: 1. Score for other factors is the sum of the positive impacts less the negative impacts. Impacts with "+" or "++" receive double score.
2. Implementation cost for this option is expected to be similar for Option B1.2A

6 SUMMARY & RECOMMENDATIONS

6.1 SUMMARY

Recent and ongoing policy development efforts have made improvements to Halifax’s transit service a key priority for the Municipality. Specifically, Halifax Transit’s *Moving Forward Together Plan* (adopted by Regional Council in April 2016) includes bold moves that will aim to improve transit service levels through increased priority, enhanced reliability, and reduced travel time. The bold moves are being made in support of the following four Council-endorsed ‘*Moving Forward Principles*’:

1. Increase the proportion of resources allocated towards high ridership services.
2. Build a simplified transfer based system.
3. Invest in service quality and reliability.
4. Give transit increased priority in the transportation network.

Among the key initiatives that the Municipality is considering for transit upgrades are Transit Priority Measures (TPMs) – strategically located street and intersection upgrades that provide priority for the movement of buses. Building on HRM’s recent success of implementing TPMs at various locations, the Municipality is interested in investigating corridor-level transit priority upgrades that satisfy specific recommendations of the *Moving Forward Together Plan* including two “critical locations” that were identified for transit priority measures: **Bayers Road** and **Gottingen Street**.

To address this identified need for transit priority along these two corridors, options were developed and evaluated against the level of impact that they are expected to have on transit operation as well as on active transportation (AT), general traffic, parking, road safety, and implementation cost.

Following initial development of the options for each corridor, consultation was held to gather input from key stakeholders and community groups through several stakeholder meetings as well as from the overall public through one public open house for each corridor and through online consultation through the project’s Shape Your City website.

Options preparation included a significant data collection phase that included topographic survey, as well as obtaining and reviewing data on transit vehicle and ridership volumes, volumes of traffic, pedestrians, and bicycle, as well as the review of available collision records and consideration of public and stakeholder input. Analysis was completed to evaluate the identified options using criteria developed through discussion with HRM staff as well as the methodology presented in Appendix E of *Moving Forward Together* (Halifax Transit, 2016).

6.2 RECOMMENDATIONS

Based on the background review, public and stakeholder consultation, functional design, various analysis frameworks, and comparative analysis, the recommendations have been developed for consideration by HRM.

Consideration was given to the phasing of corridor improvements. A proposed implementation plan has been identified with recommendations presented as Priority A, B, or C where items in Priority 'A' should generally be considered during the earlier years of the Action Plan, with those in Priority 'C' considered in the later years.

6.2.1 RECOMMENDATIONS - GOTTINGEN STREET

1. HRM should complete a parking analysis to determine the level of parking utilization for the Gottingen Street spaces and potential areas on adjacent streets that can accommodate additional parking.
2. HRM should install Option G3 along the entire corridor between Cogswell Street and North Street. This involves the removal of parking during the AM and PM peak periods and is considered the low investment option. Although this option does not specifically provide transit priority along this corridor it is expected to offer benefit to traffic progression along this corridor and provide overall road safety benefit addressing noted existing collision trend with parked vehicles.
3. HRM should install the transit priority measure at the Cornwallis Street to provide a queue jump for northbound buses.
4. HRM should consider a trial period where some parking additional parking is removed around the Cornwallis intersection to gather information on the effectiveness of providing a longer transit queue jump.
5. In the future the transit lane could be extended along the length of the corridor and consideration given to pedestrian half-signals at key pedestrian crossings.

PRIORITY 'A'

- Complete a parking analysis of utilization of parking on adjacent streets to develop a strategy to offset loss of parking along the Gottingen Street corridor.
- Implement Option G-3 (Remove parking / loading during peak periods).
- Design and install northbound transit priority measure at Cornwallis Street intersection.
- Consider some additional parking restrictions surrounding the Cornwallis Street intersection to extend the transit lane to improve operations.
- Design pedestrian half signal at Uniacke Street intersection.

PRIORITY 'B'

- Install pedestrian half signal at Uniacke Street intersection.
- Design pedestrian half signal at Cunard Street intersection.

PRIORITY 'C'

- Install pedestrian half signal at Cunard Street intersection.
- Implement continuous northbound transit lane for the full corridor on a trial basis.

6.2.2 RECOMMENDATIONS – BAYERS ROAD

Segment 1 - Romans Avenue to Halifax Shopping Centre (HSC):

1. HRM should plan for the installation of one transit only lane in each direction. In addition to providing benefit to transit during the peak direction it is expected to offer safety benefits when compared to a reversing lane and use of time of day transit lane signage.

Segment 2 - Halifax Shopping Centre (HSC) to Connaught Avenue:

2. Although the high investment option at the HSC segment is expected to create significant benefit to transit and non-transit vehicles, there are expected to be significant issues to implementation that may make this option infeasible. In addition to cost, Option 1 (overpass) is expected to have significant impacts to property with significant retaining walls and grading challenges. Option 2A through this segment provides the best overall balance of the project objectives as it is expected to provide significant transit priority while considering the urban form through this area. HRM should seek to implement the medium investment option (Option 2A) through the HSC segment.

Segment 3 - Connaught Avenue to Windsor Street:

3. Connaught Avenue is considered a key intersection along this corridor and two westbound lanes for non-transit vehicles should be provided approaching Connaught Avenue for a distance of approximately 100 metres.
4. HRM should plan for the implementation of the high investment option (one continuous transit lane in each direction) through this segment.
5. Depending on construction timelines, a phased approach could be implemented where:
 - a. Road widening between Connaught Avenue and Connolly Street could provide the transit priority lanes and maintain the two westbound through lanes. This could be accompanied by signage and marking modifications east of Connolly to provide a westbound transit lane while maintaining existing road width.
 - b. Widening east of Connolly Street should be completed in a subsequent construction phase.

Segment 4 - Windsor Street Intersection:

6. In addition to providing transit priority in both directions, the high investment option is expected to offer benefits by modifying the right turn channels from Windsor Street to provide improved lane geometry and alignment at the intersection and provide improved lane balance with recommended improvements in Segment 3. HRM should plan for the implementation of this option.

PRIORITY 'A'

- Initiate acquisition of identified properties to implement Option B-1.2 (Medium investment through HSC segment, High investment otherwise).
- Design and implement modifications for continuous transit lanes in both directions for Romans Avenue to HSC.
- Design and implement modifications for Option 2A (Medium investment) through the HSC segment. This should include road widening that extends 100 metres east of Connaught Avenue to provide transit priority and two westbound approach lanes at that intersection.
- Consider modifications to provide a westbound transit lane (Option 3) between Windsor Street and Connolly Street.
- Design modifications at the Windsor Street intersection.

PRIORITY 'B'

- Implement modifications at the Windsor Street intersection.
- Design modifications to install a transit lane in each direction between Connaught Avenue and Windsor Street.

PRIORITY 'C'

- Implement modifications to provide a continuous transit lane in each direction between Connolly Street and Windsor Street.

APPENDIX

A FUNCTIONAL DESIGNS



Functional Designs
Are Included in the HRM Staff Report

APPENDIX

B

PUBLIC

CONSULTATION

FEEDBACK

FORMS

Public Consultation Feedback Forms
Are Included in the HRM Staff Report

APPENDIX

C ONLINE CONSULTATION RESULTS

Online Consultation Results
Are Included in the HRM Staff Report

APPENDIX

D COST ESTIMATES

HRM TRANSIT PRIORITY CORRIDORS - GOTTINGEN STREET

HIGH LEVEL ESTIMATE OF PROBABLE COSTS



PROJECT NO. 171-09619
 DATE: Jan. 15, 2018
 CLIENT: HRM
 CONSULTANT: WSP
 UNIT PRICE SOURCE: WSP

Disclaimer: This estimate of probable construction cost is approximate only. Actual cost may vary significantly from this estimate due to market conditions such as material and labour costs, time of year, industry workload, competition, etc. This estimate has been prepared based on our experience with similar projects. This estimate has not been prepared by obtaining any estimates or quotes from contractors. Due to the uncertainties of what contractors bid, WSP cannot make any assurances that this estimate will be within a reasonable range of the tendered low bid. When assessing this project for business feasibility purposes this estimate should not be relied upon without considering these factors.

NOTE:

1. HST NOT INCLUDED IN INDICATED UNIT PRICES AND TOTALS.
2. ESTIMATE BASED ON FUNCTIONAL DESIGN DRAWINGS PROVIDED FOR PUBLIC OPEN HOUSE ON OCT. 2, 2017.
3. ALL PRICES SHOWN ARE IN 2017 CANADIAN DOLLARS.
4. ESTIMATE DOES NOT INCLUDE ALLOWANCES FOR ENGINEERING, ADMINISTRATION OR INSPECTION FEES.
5. COSTS AND QUANTITIES ASSUME NO OTHER WORK IS BEING DONE IN CONJUNCTION WITH TRANSIT PRIORITY IMPROVEMENT MEASURES.
6. OPTION G3 (LOW INVESTMENT SCENARIO) IS NOT SHOWN SINCE THE ONLY COST IS FOR REPLACEMENT OF STOPPING / PARKING RESTRICTION SIGNS WHICH IS EXCLUDED FROM THESE ESTIMATES.

ITEM	DESCRIPTION	UNITS	UNIT PRICE	Option G1*		Option G2*	
				QNTY.	COST	QNTY.	COST
STREET CONSTRUCTION							
46	Signs (Incl. reinstatement)	each	\$1,500	4	\$6,000	2	\$3,000
ADDITIONAL ITEMS							
65.1	Pavement Markings	LS	Varies	1	\$14,100	1	\$10,800
65.2	Removal of Existing Pavement Markings	LS	Varies	1	\$6,000	1	\$6,000
65.3	Red In-Lay Reserved Lane Symbol	each	\$5,000	6	\$30,000	3	\$15,000
ELECTRICAL							
85	Installation of Half Signals	LS	\$75,000	2	\$150,000	2	\$150,000
MISCELLANEOUS							
93	Traffic Control	LS	Varies	1	\$25,000	1	\$25,000

Sub-Total	\$231,100	\$209,800
Contingency (30%)	\$69,330	\$62,940
ESTIMATED COST (excl. HST)	\$300,000	\$273,000

***OPTIONS**

G1	Continuous Northbound Transit Lane
G2	NB Transit Priority at Key Intersections

**HRM TRANSIT PRIORITY CORRIDORS
HIGH LEVEL ESTIMATE OF PROBABLE COSTS**



PROJECT NO. 171-09619
 DATE: Jan. 15, 2018
 CLIENT: HRM
 CONSULTANT: WSP
 UNIT PRICE SOURCE: WSP
 NOTES:

Disclaimer: This estimate of probable construction cost is approximate only. Actual cost may vary significantly from this estimate due to market conditions such as material and labour costs, time of year, industry workload, competition, etc. This estimate has been prepared based on our experience with similar projects. This estimate has not been prepared by obtaining any estimates or quotes from contractors. Due to the uncertainties of what contractors bid, WSP cannot make any assurances that this estimate will be within a reasonable range of the tendered low bid. When assessing this project for business feasibility purposes this estimate should not be relied upon without considering these factors.

- HST NOT INCLUDED IN INDICATED UNIT PRICES AND TOTALS.
- ESTIMATE BASED ON FUNCTIONAL DESIGN DRAWINGS PROVIDED FOR PUBLIC OPEN HOUSE ON SEPT. 28, 2017.
- ALL PRICES SHOWN ARE IN 2017 CANADIAN DOLLARS.
- ESTIMATE DOES NOT INCLUDE COST ALLOWANCES FOR PROPERTY ACQUISITION, UTILITY POLE RELOCATION, ENGINEERING, ADMINISTRATION OR INSPECTION
- COSTS AND QUANTITIES ASSUME ONLY A.T. TRAIL INSTALLATION AND NO ADDITIONAL WORK IS BEING DONE IN CONJUNCTION WITH TRANSIT PRIORITY IMPROVEMENT
- STREET CONSTRUCTION UNIT PRICE INCLUDES PLACEMENT OF TYPE I AND TYPE II GRAVELS, AND TYPE B-HF AND TYPE C-HF ASPHALT.
- OPTION B2 ASSUMES PLANNING AND OVERLAY OF 50mm TYPE C-HF ASPHALT FOR HALIFAX SHOPPING CENTER INTERSECTION AREA.

ITEM	DESCRIPTION	UNITS	UNIT PRICE	Option B1.1		Option B1.2		Option B1.3		Option B2		Option B3	
				QNTY.	COST	QNTY.	COST	QNTY.	COST	QNTY.	COST	QNTY.	COST
EARTHWORKS													
3	Mass Excavation & Embankment	m3	\$25	5,000	\$125,000	2,500	\$62,500	0	\$0	2,500	\$62,500	500	\$12,500
4	Excavation - Rock	m3	\$100	5,000	\$500,000	0	\$0	0	\$0	0	\$0	0	\$0
5	Unsuitable Material	m3	\$40	1,000	\$40,000	0	\$0	0	\$0	0	\$0	0	\$0
6	Replacement of Unsuitables	m3	\$55	1,000	\$55,000	0	\$0	0	\$0	0	\$0	0	\$0
7	Borrow	m3	\$25	10,000	\$250,000	0	\$0	0	\$0	0	\$0	0	\$0
9.2	Fine Grading of Road Surface	m2	\$2	14,000	\$28,000	10,530	\$21,060	4,300	\$8,600	9,150	\$18,300	1,800	\$3,600
WATER SYSTEM													
10	Pipe (Removal and Replacement)	m	\$750	400	\$300,000	0	\$0	0	\$0	0	\$0	0	\$0
11	Hydrant (Removal and Replacement)	each	\$7,500	2	\$15,000	0	\$0	0	\$0	0	\$0	0	\$0
13	Valve (Removal and Replacement)	each	\$5,000	10	\$50,000	0	\$0	0	\$0	0	\$0	0	\$0
14.3.1	Service Fittings (Removal and Replacement)	each	\$2,500	7	\$17,500	0	\$0	0	\$0	0	\$0	0	\$0
14.3.2	Service Pipe (Removal and Replacement)	m	\$250	70	\$17,500	0	\$0	0	\$0	0	\$0	0	\$0
15	Connection to Existing Main	each	\$6,000	6	\$36,000	0	\$0	0	\$0	0	\$0	0	\$0
17	Temporary Water Service	LS	\$50,000	1	\$50,000	0	\$0	0	\$0	0	\$0	0	\$0
SANITARY SYSTEM (COMBINED)													
20	Gravity Pipe (Removal and Replacement)	m	\$750	400	\$300,000	0	\$0	0	\$0	0	\$0	0	\$0
22	Manholes (Removal and Replacement)	each	\$8,500	22	\$187,000	0	\$0	0	\$0	0	\$0	0	\$0
23	Services (Removal and Replacement)	m	\$650	150	\$97,500	0	\$0	0	\$0	0	\$0	0	\$0
24	Connection to Existing Main	each	\$2,500	15	\$37,500	0	\$0	0	\$0	0	\$0	0	\$0
STORM SEWER													
32.1	Catchbasin Relocation / Installation	each	\$6,500	56	\$364,000	41	\$266,500	31	\$201,500	30	\$195,000	15	\$97,500
33.2	Catchbasin Leads (Removal and Replacement)	m	\$600	392	\$235,200	287	\$172,200	217	\$130,200	210	\$126,000	105	\$63,000
STREET CONSTRUCTION													
Note 6	Street Construction (Excavation, gravels, asphalt)	m2	\$125	14,000	\$1,750,000	5,530	\$691,250	4,300	\$537,500	4,150	\$518,750	1,800	\$225,000
42.23	Mill & Asphalt Overlay (See Note 7)	m2	\$30	0	\$0	5,000	\$150,000	0	\$0	5,000	\$150,000	0	\$0
42.25	Street Removal	m2	\$10	7,000	\$70,000	1,250	\$12,500	1,025	\$10,250	630	\$6,300	300	\$3,000
43.2	Curb Installation	m	\$120	3,800	\$456,000	3,200	\$384,000	2,400	\$288,000	2,300	\$276,000	850	\$102,000
43.4	Curb Removal	m	\$20	3,500	\$70,000	3,100	\$62,000	2,550	\$51,000	2,100	\$42,000	850	\$17,000
44.1	Sidewalk Installation	m2	\$100	3,000	\$300,000	2,500	\$250,000	2,275	\$227,500	1,100	\$110,000	300	\$30,000
44.13	Sidewalk Removal	m2	\$15	4,700	\$70,500	4,700	\$70,500	4,150	\$62,250	2,800	\$42,000	1,350	\$20,250
44.14	Concrete Island	m2	\$130	1,100	\$143,000	1,050	\$136,500	380	\$49,400	1,000	\$130,000	330	\$42,900
44.15	Bus Pad Relocation	m2	\$200	130	\$26,000	130	\$26,000	130	\$26,000	130	\$26,000	130	\$26,000
44.16	Transit Bench / Shelter Relocation	each	\$1,500	1	\$1,500	1	\$1,500	1	\$1,500	1	\$1,500	1	\$1,500
44.17	A.T. Trail	m	\$130	1,800	\$234,000	1,800	\$234,000	1,800	\$234,000	1,720	\$223,600	1,720	\$223,600
45	Retaining Wall	m2	\$750	1,500	\$1,125,000	50	\$37,500	0	\$0	150	\$112,500	100	\$75,000
46.3	Signs	each	\$650	40	\$26,000	37	\$24,050	30	\$19,500	40	\$26,000	15	\$9,750
LANDSCAPING													
54.2	Tree Removal (< 400mm)	each	\$700	10	\$7,000	10	\$7,000	12	\$8,400	9	\$6,300	11	\$7,700
54.3	Tree Removal (> 400mm)	each	\$1,800	16	\$28,800	16	\$28,800	16	\$28,800	5	\$9,000	2	\$3,600
50	Topsoil & Sod	m2	\$15	6,000	\$90,000	5,000	\$75,000	3,750	\$56,250	3,500	\$52,500	2,500	\$37,500
57	Handrail / Fence	m	\$110	500	\$55,000	250	\$27,500	200	\$22,000	250	\$27,500	200	\$22,000
ADDITIONAL ITEMS													
60	Trench Excavation - Rock	m3	\$105	800	\$84,000	60	\$6,300	30	\$3,150	120	\$12,600	60	\$6,300
61	Trench Excavation - Unsuitable Material	m3	\$55	800	\$44,000	60	\$3,300	30	\$1,650	120	\$6,600	60	\$3,300
62	Replacement of Unsuitable Material	m3	\$60	800	\$48,000	60	\$3,600	30	\$1,800	120	\$7,200	60	\$3,600
65.1	Pavement Markings	LS	\$40,000	1	\$40,000	1	\$40,000	1	\$40,000	1	\$40,000	1	\$40,000
65.2	Removal of Existing Pavement Markings	LS	\$10,000	1	\$10,000	1	\$10,000	1	\$10,000	1	\$10,000	1	\$10,000
65.3	Red In-Lay Reserved Lane Symbol	each	\$5,000	8	\$40,000	10	\$50,000	8	\$40,000	9	\$45,000	3	\$15,000
ENVIRONMENTAL PROTECTION													
70	Environmental Protection Allowance	LS	\$20,000	1	\$20,000	1	\$20,000	1	\$20,000	1	\$20,000	1	\$20,000
ELECTRICAL													
85	Intersection Signals (Installation or Replacement)	LS	\$250,000	3	\$750,000	3	\$750,000	2	\$500,000	3	\$750,000	2	\$500,000
87	Street Lights	each	\$10,000	15	\$150,000	6	\$60,000	0	\$0	6	\$60,000	0	\$0
88	Traffic Signal Relocation	pole	\$10,000	4	\$40,000	4	\$40,000	8	\$80,000	2	\$20,000	4	\$40,000
89	Intersection Traffic Signal Removal	LS	\$50,000	1	\$50,000	0	\$0	0	\$0	0	\$0	0	\$0
90	Undergrounding Electrical at Overpass	LS	\$300,000	1	\$300,000	0	\$0	0	\$0	0	\$0	0	\$0
MISCELLANEOUS													
91	Guiderail / Jersey Barrier Installation	m	\$150	450	\$67,500	0	\$0	0	\$0	0	\$0	0	\$0
92	Natural Gas Pipe (Removal and Replacement)	m	\$350	200	\$70,000	0	\$0	0	\$0	0	\$0	0	\$0
93	Traffic Control	LS	Varies	1	\$600,000	1	\$250,000	1	\$150,000	1	\$250,000	1	\$100,000
94	O/H Reversing Lane Sign Structures	each	\$40,000	0	\$0	0	\$0	0	\$0	10	\$400,000	3	\$120,000
95	Bridge Structure	LS	\$3,000,000	1	\$3,000,000	0	\$0	0	\$0	0	\$0	0	\$0

OPTIONS	
B1.1	High Investment Scenario
B1.2	High Investment with Medium HSC Scenario
B1.3	High Investment with Low HSC Scenario
B2	Medium Investment Scenario
B3	Low Investment Scenario

	Option B1.1	Option B1.2	Option B1.3	Option B2	Option B3
Sub-Total	\$12,471,500	\$3,973,560	\$2,809,250	\$3,783,150	\$1,881,600
Contingency (30%)	\$3,741,450	\$1,192,068	\$842,775	\$1,134,945	\$564,480
TOTAL COST (excl. HST)	\$16,213,000	\$5,166,000	\$3,652,000	\$4,918,000	\$2,446,000

APPENDIX

E SAMPLE DELAY AND PAYBACK CALCULATIONS

Using the Net User Delay Methodology developed in the *Transit Priority Measures Study* (WSP, 2016) as well the Transit ridership data and delay estimates obtained for each location it is possible to calculate the net road user delay during the subject peak hour as well as the payback periods associated with each measure. These equations are included below.

$$\text{Net Change in Road User Delay} = \text{Net Transit User Delay} + \text{Net Non Transit User Delay}$$

Where:

$$\text{Net Change in Transit User Delay} = \text{Delay/Transit Vehicle} \times \# \text{ Transit Vehicles} \times \text{Average Ridership per Transit Vehicle}$$

And,

$$\text{Net Change in Non Transit User Delay} = \text{Delay/Non Transit Vehicle} \times \# \text{ Non Transit Vehicles} \times \text{Average Vehicle Occupancy}$$

Note: Delay reductions will be a negative value while delay increases will be a positive value.

$$\text{Daily Change in Cost to Transit}$$

$$= \text{Average Change in Delay/Transit Vehicle} \times \# \text{ Transit Vehicles} \times \text{Cost/hour for Transit Vehicle}$$

$$\text{Annual Change in Cost to Transit} = \text{Daily Change in Cost to Transit} \times \text{Days/Year TPM is in Use}$$

$$\text{Daily Change in Cost to Public} = \text{Daily Change in Person Cost} + \text{Daily Change in nonTransit Vehicle Cost}$$

Where

$$\text{Daily Change in Person Cost}$$

$$= \text{Net Change in Road User Delay} \times \# \text{ hours TPM will be in effect per day} \times \text{Cost/hour for Road User}$$

$$\text{Daily Change in nonTransit Vehicle Cost}$$

$$= \text{Average delay change per nonTransit user} \times \# \text{ of NonTransit vehicles} \times \text{Cost /hour for nonTransit Vehicle}$$

$$\text{Annual Change in Cost to Public} = \text{Daily Change in Cost to Public} \times \text{Days/Year TPM is in Use}$$

$$\text{Payback Period} = \frac{\text{TPM Capital Cost}}{\text{Annual Cost Savings to Transit} + \text{Annual Cost Savings to Public} - \text{Annual Change in Operating Cost}}$$

Parking Loss Mitigation Plan

Gottingen Street Transit Priority Corridor

Prepared by:

Strategic Transportation Planning
June 2018

HALIFAX

HALIFAX

Table of Contents

- Introduction 3**
 - Background 3
 - Objectives 3
- Existing On-Street Parking 3**
 - Existing Parking Supply 3
 - Existing Parking Utilization 8
- Existing On-Street Loading 9**
 - Existing Loading Supply 9
 - Existing Loading Operations 9
- Proposed Impacts to Parking and Loading 11**
 - Proposed Street Configuration 11
 - Parking and Loading Impacts 11
 - North Street to Uniacke Street 13
 - Uniacke Street to Prince William Street 14
 - Prince William Street to Cornwallis Street 15
 - Cornwallis Street to Portland Place 16
 - Portland Place to Cogswell Street 17
- Concluding Thoughts 18**

Introduction

Background

The proposed peak period transit lane on Gottingen Street will impact on-street parking and loading activities. Recognizing the importance of both of these curbside activities to businesses and residents of the area, Regional Council has directed staff to prepare a plan that reviews the impacts resulting from the design and identifies opportunities to mitigate any anticipated losses.

In preparing the detailed design and parking loss mitigation plan, staff have completed an investigation of existing on-street parking and loading activities on Gottingen Street that included a detailed parking / loading inventory, collection of utilization data, and consultation with local stakeholders and the public.

Objectives

The objective of the parking loss mitigation plan is to understand the current parking and loading conditions on Gottingen Street and identify design options that aim to reduce the net loss of both.

Existing On-Street Parking

Existing Parking Supply

Curb access on Gottingen Street currently includes a mixture of time-restricted on-street parking (including designated accessible spaces), unrestricted on-street parking, loading, and bus stops. There are also several locations where curb access is prohibited due to insufficient width or due to proximity to intersections, crosswalks, and fire hydrants. Figure 1 summarizes existing curbside access on Gottingen Street. Existing parking and loading is presented in a more detailed manner for Gottingen Street and the surrounding streets in Figures 2-5.

There are approximately 52 parking spaces on Gottingen Street between North Street and Cogswell Street during off-peak hours. During peak hours, the 24 parking spaces on the east side of the street are restricted (“No Stopping” between 4-6pm). The 28 parking spaces on the west side of the street are available during all hours of the day.

Parking time restrictions vary from 15-60 minutes along Gottingen Street. The supply of short duration parking is intended to promote turnover, and increase the ease of accessing businesses and other uses on the street.

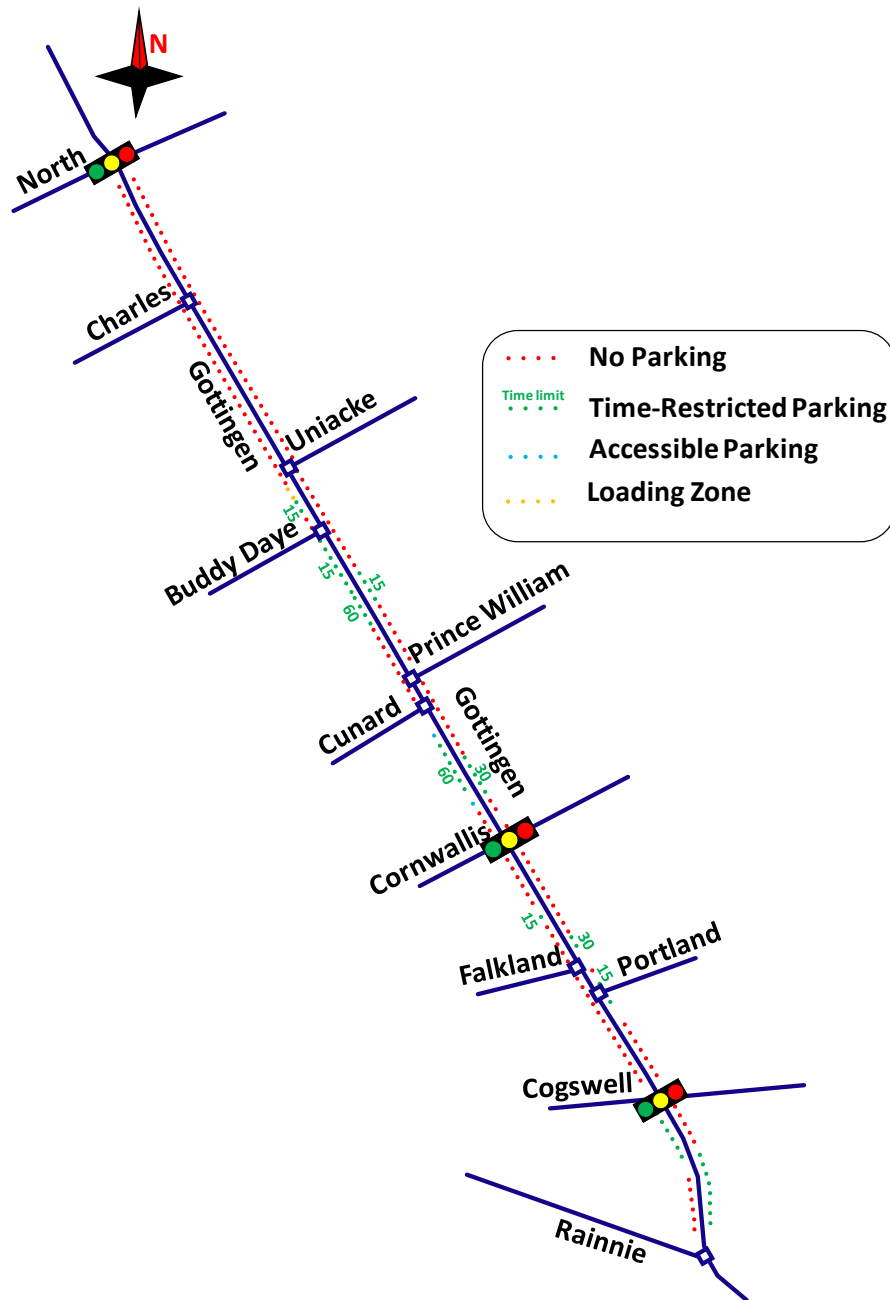

Figure 1: Existing Curbside Inventory -- Gottingen Street

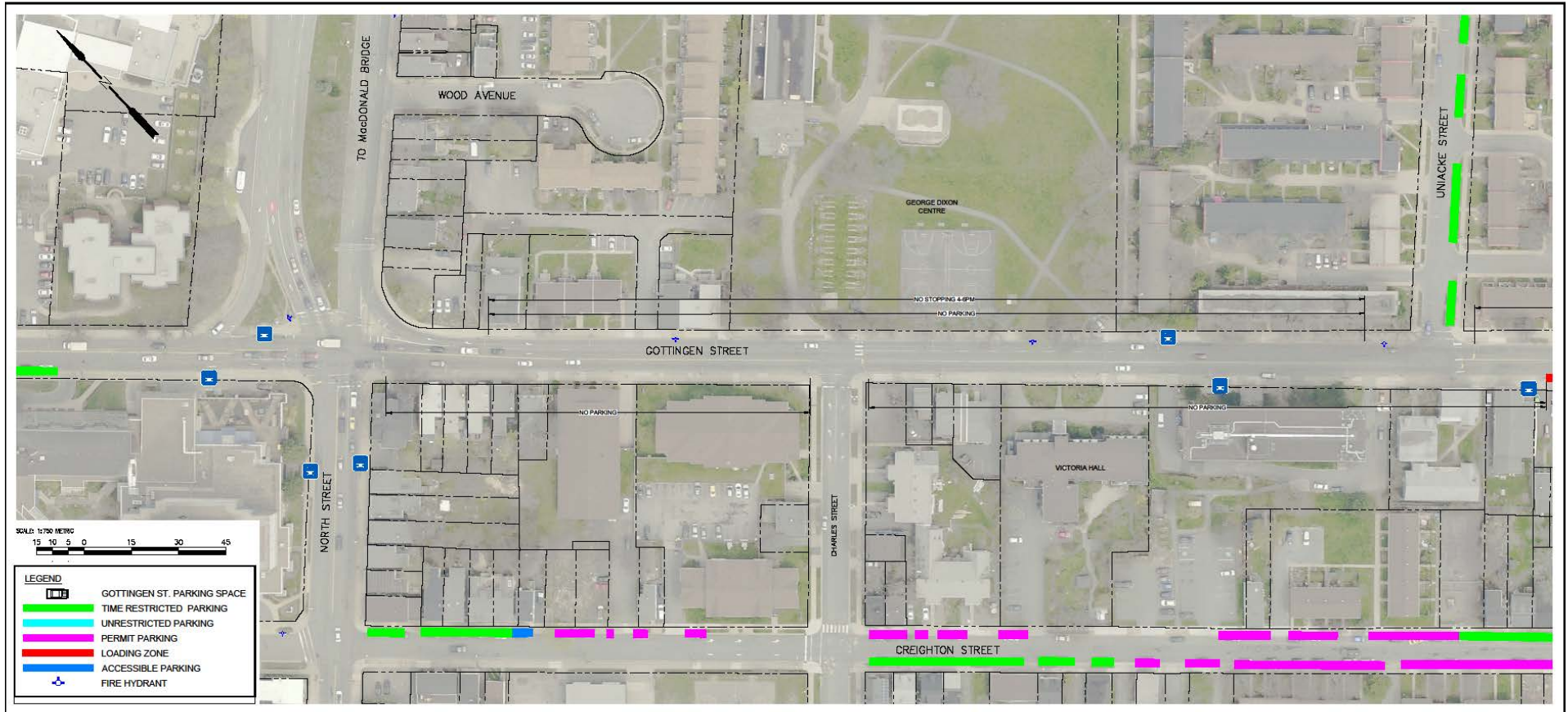

Figure 2: Existing Conditions – North Street to Uniacke Street

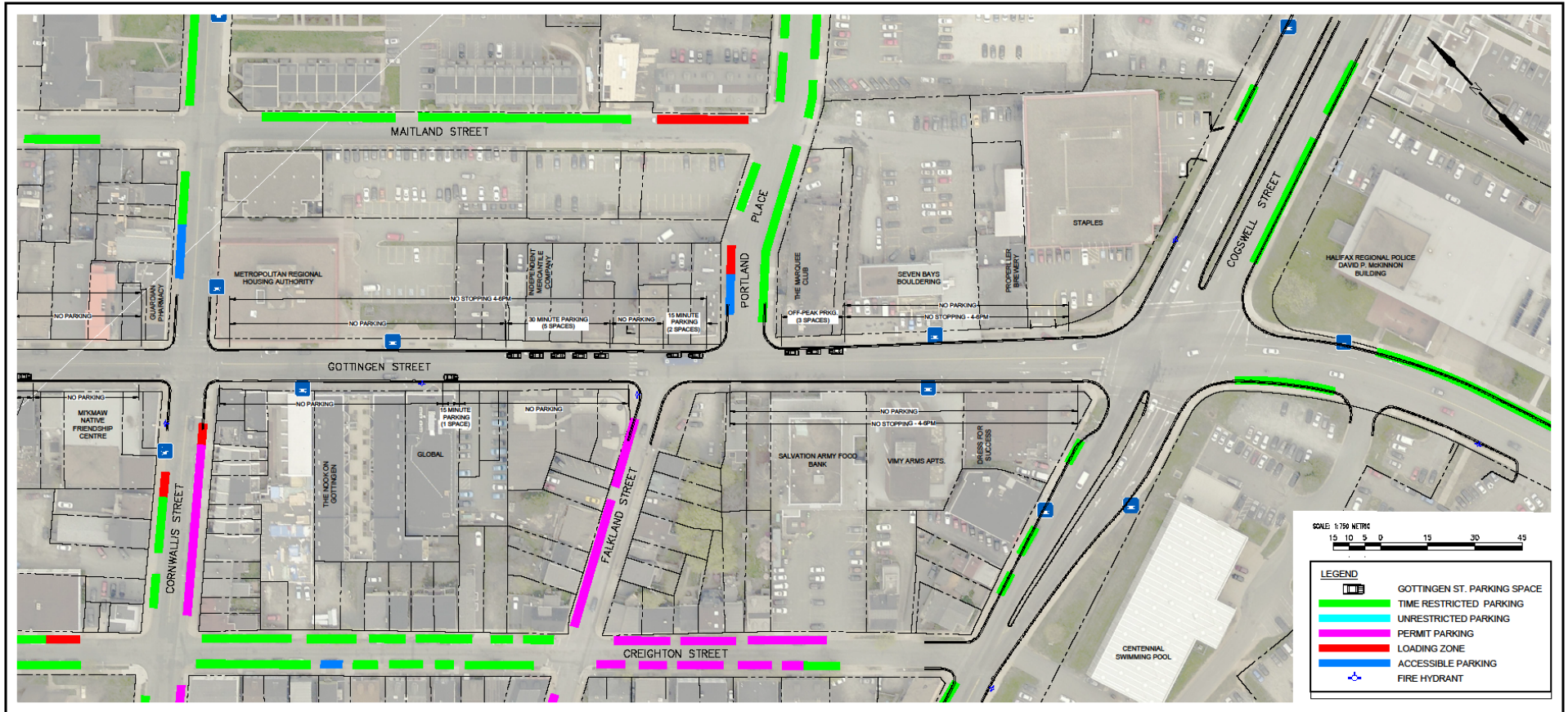

Figure 4: Existing Conditions – Cornwallis Street to Cogswell Street

Existing Parking Utilization

Parking utilization observations were made over a 7-hour period on Thursday, February 8 and Wednesday, April 25, 2018 on Gottingen Street and the surrounding streets within a one block radius. A staff survey was completed on Thursday, February 8th, 2018 and a consultant survey was completed on Wednesday, April 25th, 2018. Both surveys had consistent results, indicating average parking occupancy on Gottingen Street was 54-55% between 9am and 4pm, and the average time a vehicle remained in the same parking space was 85-90 minutes. Average parking utilization aggregated for all side streets ranged between 60-66% for the two days.

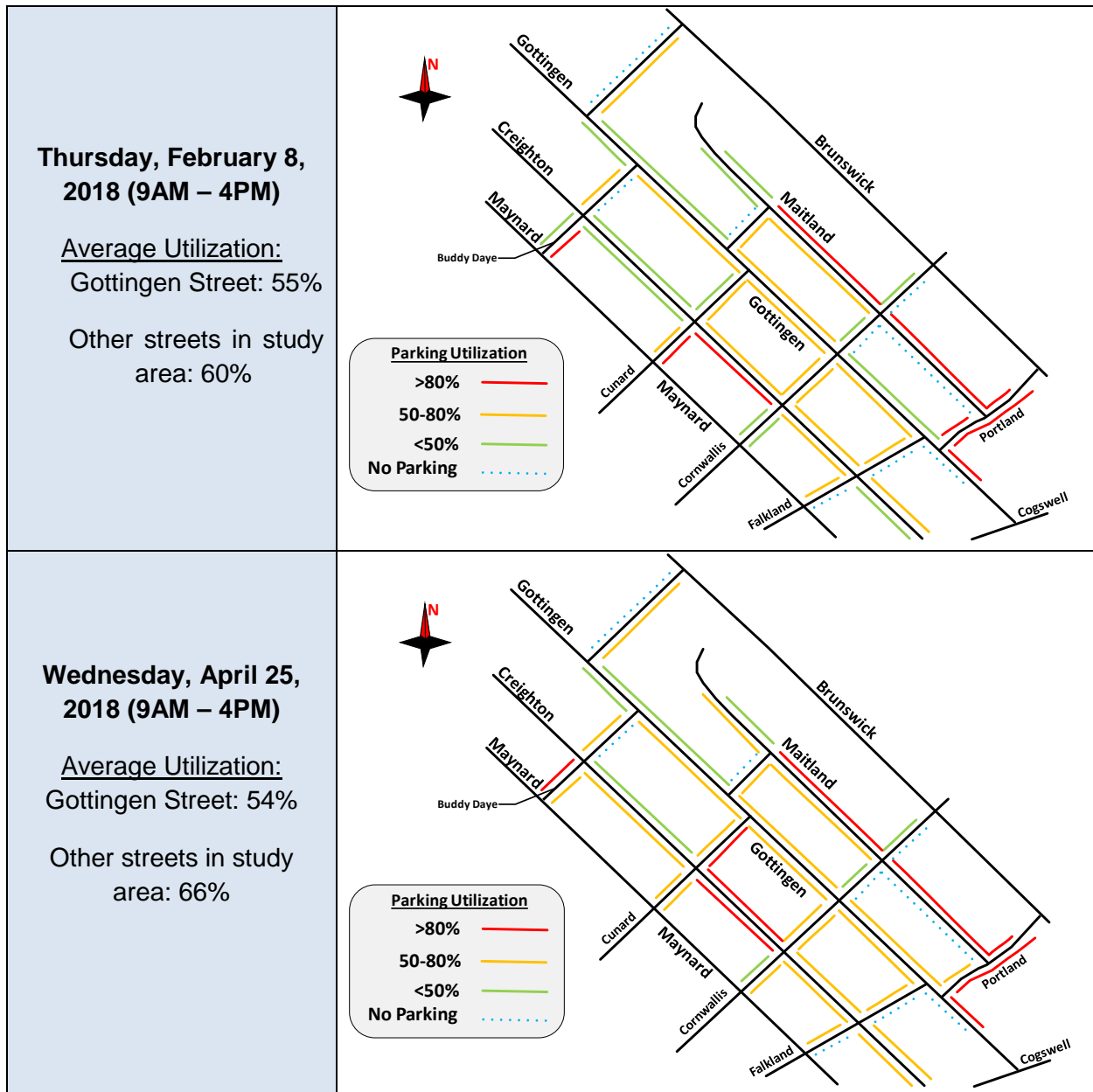

Figure 5: Summary of Parking Utilization for Gottingen Street and adjacent streets

Existing On-Street Loading

Existing Loading Supply

The Nova Scotia *Motor Vehicle Act* allows stopping temporarily within a “No Parking” zone while engaged in loading or unloading. Areas intended for loading are signed “No Parking” along Gottingen Street; there is also one formally signed “Loading Zone” near Uniacke Street. Curbside space on the street is currently not optimized for on-street parking, which benefits the supply of areas where loading is permitted along the street. Total “No Parking” areas range between 60-120m per block on the blocks with commercial businesses.

Existing Loading Operations

Currently, the majority of on-street loading takes place from open parking spaces or No Parking zones. Some businesses in the Portland Place area also have off-street loading. Loading can currently take place on the west side of Gottingen Street any time of day, and is restricted from 4-6pm on the east side (signed “No Stopping” during this period).

Staff completed a survey of businesses on Gottingen Street to better understand current loading operations. The survey included questions related to typical loading activities including time of day, frequency, location, and vehicle type. Key findings included:

- **Loading Frequency / Duration:**
 - While some businesses in the study area have alternative loading options, nearly every business surveyed indicated that they received curbside deliveries on Gottingen Street at least once a month
 - 59% of respondents load during weekdays and outside of peak hours exclusively;
 - 83% of respondents indicated typical loading operations have a duration of 30 minutes or less;
 - Of businesses that receive deliveries daily or multiple times daily, 58% report a delivery duration of 15 minutes or less.
- **Loading Vehicle:**
 - Five of the respondents indicated that they have some deliveries by tractor trailer. Other businesses receive deliveries from smaller delivery trucks and couriers, cargo vans, and cars.
- **Loading Location:**
 - Nearly every business surveyed indicated that loading activities typically take place directly in front of the business.

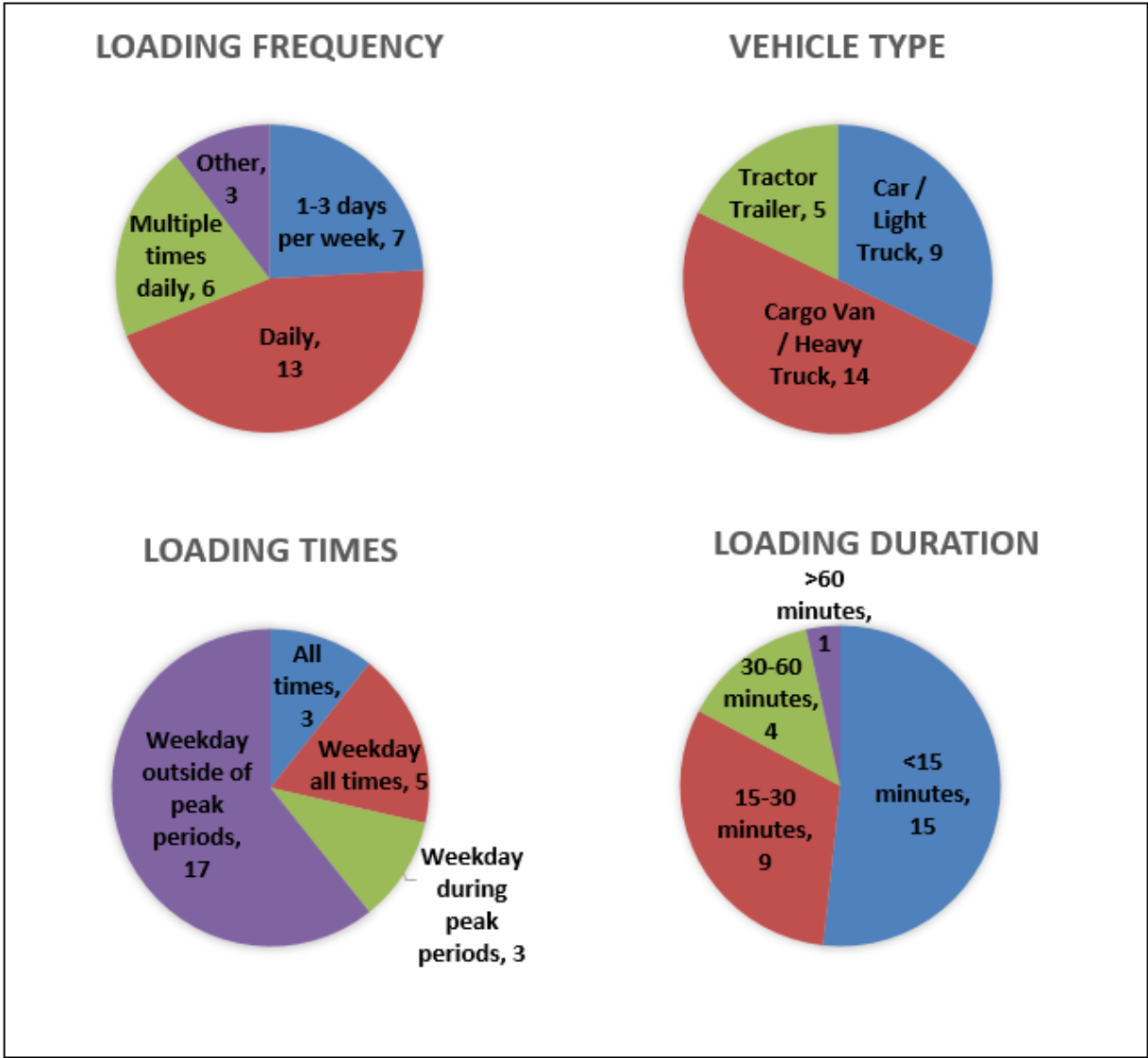

Figure 6: Loading operations survey results

Proposed Impacts to Parking and Loading

Proposed Street Configuration

The proposed configuration for the Gottingen Street transit priority corridor, as summarized in Figure 7, includes a time-restricted northbound transit lane on the east side of Gottingen Street that provides dedicated space for buses during weekday peak traffic periods (7AM-9AM, 3PM-6PM). During off-peak periods, the lane accommodates time-regulated parking and loading. Right-turning traffic are also permitted to use the lane at intersections.

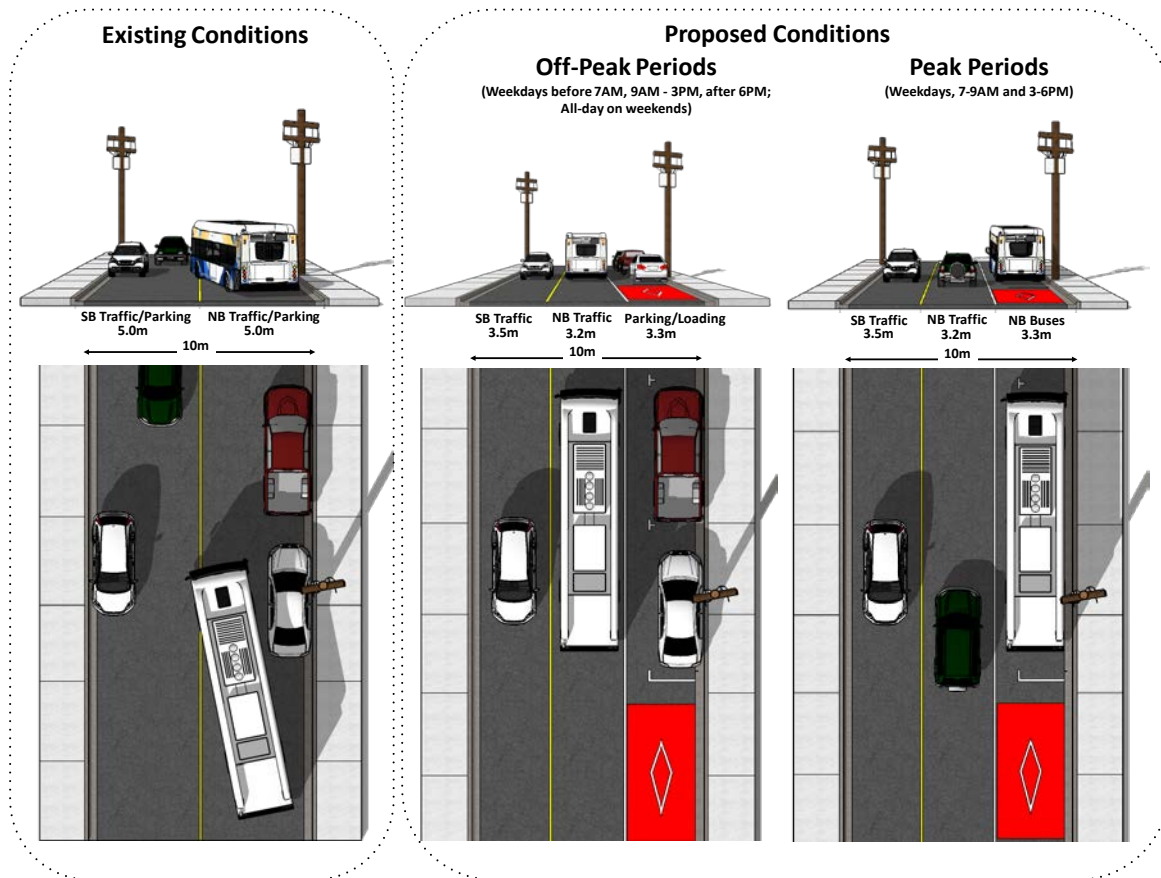

Figure 7: Existing and proposed typical cross section (looking to the north) - Gottingen Street

Parking and Loading Impacts

The proposed street layout will have a notable impact to parking and loading operations. All parking and loading will be restricted on the west side of Gottingen Street throughout the day. This trade off is necessary to organize the street in a way that allows for a peak hour transit only lane. The proposed design organizes the available parking and loading in a manner that optimizes parking more than current conditions. With the proposed design, loading areas are allocated on each block depending on the availability of off-street and side street loading, the size of vehicles being used for loading, length of each block, and the density of businesses. The number of parking spaces and “No Parking” (loading permitted) areas under existing and proposed conditions are summarized in Table 1.

Table 1: Approximate Parking and Loading Inventory

		# of On-Street Off-peak Parking Spaces			Parking Usage		No Parking (Loading Permitted)	
		Existing	Proposed	Net Change	Average Occupancy	Average Duration	Existing	Proposed
North Street to Uniacke Street	East Side	0	6	+6	-	-	330 m	0 m
	West Side	0	0	-	-	-	330 m	0 m
Uniacke Street to Prince William Street	East Side	6	15	+9	14%	40 mins	100 m	66 m
	West Side	15	0	-15	46%	66 mins	20 m	0 m
Prince William Street to Cornwallis Street	East Side	7	9	+2	51%	96 mins	35 m	42 m
	West Side	12	0	-12	75%	148 mins	25 m	0 m
Cornwallis Street to Portland Place	East Side	7	10	+3	53%	60 mins	35 m	12 m
	West Side	1	0	-1	61%	54 mins	25 m	0 m
Portland Place to Cogswell Street	East Side	4	4	-	90%	285 mins	12 m	12 m
	West Side	0	0	-	-	-	75 m	12 m
Total		52	44	-8	55%	87 mins	987	144

The following sections provide a segment-by-segment review of existing and proposed parking and loading supply.

North Street to Uniacke Street

Existing and proposed parking / loading for the section of Gottingen Street between North Street and Uniacke Street is summarized in Table 2.

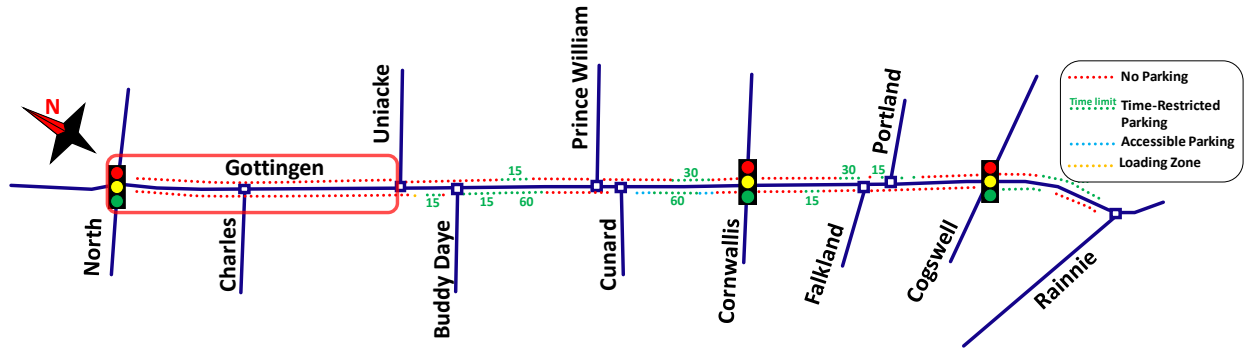

Figure 8: North Street to Uniacke Street Parking and No Parking (Loading Permitted) Areas

Table 2: North Street to Uniacke Street Curbside Inventory

		# of On-Street Off-peak Parking Spaces			Parking Usage		No Parking (Loading Permitted)	
		Existing	Proposed	Net Change	Average Occupancy	Average Duration	Existing	Proposed
North Street to Uniacke Street	East Side	0	6	+6	-	-	330 m	0 m
	West Side	0	0	-	-	-	330 m	0 m
	Total	0	6	+6	-	-	330 m	0 m

Parking

The proposed design will add six off-peak parking spaces to the east side of the street, near the intersection of Uniacke Street. Previously, there was no parking in this section.

Loading

Gottingen Street in this area is currently signed as “No Parking”, so loading could take place, but there is relatively low demand for on-street loading through this block. Most properties are residential and have off-street parking and loading. Curbside space will become “No Stopping”.

Uniacke Street to Prince William Street

Existing and proposed parking / loading for the section of Gottingen Street between Uniacke Street and Prince William Street is summarized in Table 3..

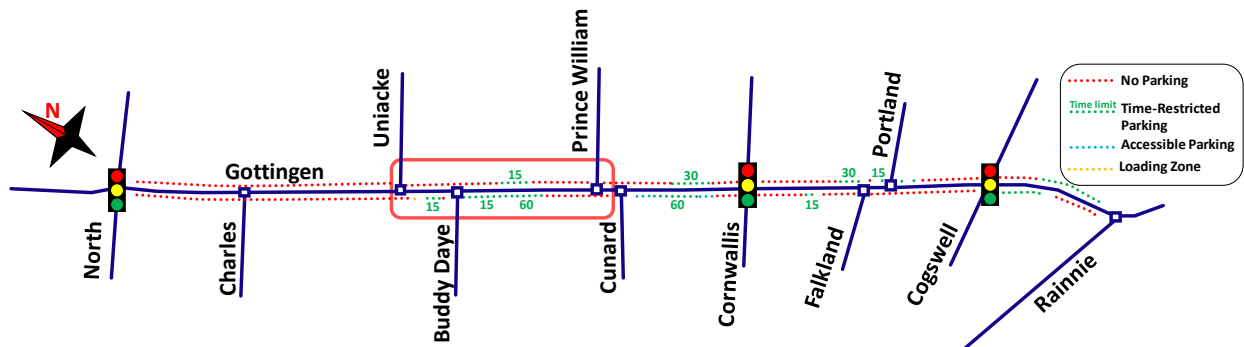

Figure 9: Uniacke Street to Prince William Street Parking and No Parking (Loading Permitted) Areas

Table 3: Uniacke Street to Prince William Street Curbside Inventory

		# of On-Street Off-peak Parking Spaces			Parking Usage		No Parking (Loading Permitted)	
		Existing	Proposed	Net Change	Average Occupancy	Average Duration	Existing	Proposed
Uniacke Street to Prince William Street	East Side	6	15	+9	14%	40 mins	100 m	66 m
	West Side	15	0	-15	46%	66 mins	20 m	0 m
	Total	21	15	-6	37%	60 mins	120 m	66m

Parking

The proposed design will remove six spaces over the 230m section of street. Parking will be prohibited on the west side, and there will be 15 parking spaces on the east side. The parking utilization data indicated average occupancy of 37% and average parking duration of 60 minutes, with many of those vehicles being in the 15-minute zones. Given the relatively low utilization and turnover, it is expected that increased enforcement improved parking turnover should mitigate the impacts of the six parking spaces that will be lost.

Loading

The proposed configuration includes approximately 66m of “No Parking” (loading permitted) areas on the east side of the street. These “No Parking” are located near marked crosswalks, where possible, which enables wheeled lifts to use curb ramps. Some businesses indicated that they receive deliveries from tractor trailers, so two loading zones were placed near these businesses that would accommodate larger vehicles. When a tractor trailer is not parked in these spaces, two mid-sized trucks could fit within the same area. Although side street loading on Buddy Daye Street was considered for additional loading area, it has not been recommended as it would necessitate removal of existing parking spaces large trucks would be difficult to accommodate, and would require trucks to exit via the surrounding residential streets.

Prince William Street to Cornwallis Street

Existing and proposed parking / loading for the section of Gottingen Street between Prince William Street and Cornwallis Street is summarized in Table 4.

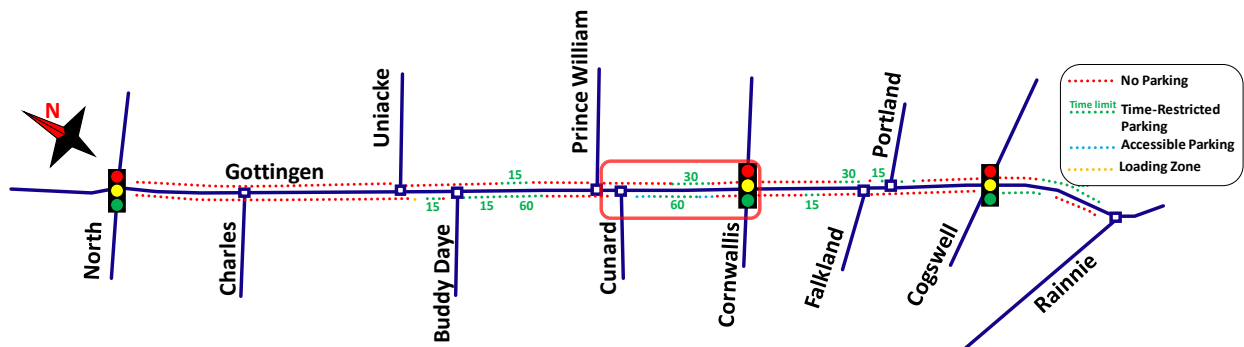

Figure 10: Prince William Street to Cornwallis Street Parking and No Parking (Loading Permitted) Areas

Table 4: Prince William Street to Cornwallis Street Curbside Inventory

		# of On-Street Off-peak Parking Spaces			Parking Usage		No Parking (Loading Permitted)	
		Existing	Proposed	Net Change	Average Occupancy	Average Duration	Existing	Proposed
Prince William Street to Cornwallis Street	East Side	7	9	+2	51%	96 mins	35 m	42 m
	West Side	12	0	-12	75%	148 mins	25 m	0 m
	Total	19	9	-10	66%	130 mins	60 m	42 m

Parking

The proposed design has 9 parking spaces on the east side, and none on the west, for a total loss of 10 spaces on this segment. This block has existing 30-60 minute timed parking restrictions. The parking utilization data indicated average occupancy of 66% and average parking duration of 130 minutes. Long term parking within this section has a negative impact on the intended high turnover parking operations for this mixed used commercial and residential street. With increased enforcement, drivers who are currently parking for extended periods of time will no longer be permitted to park on Gottingen Street. Given the moderate utilization and low turnover, it is expected that increased enforcement improved parking turnover should mitigate the impacts of the six parking spaces that will be lost.

Loading

This section is dense with commercial uses, and was found to have varying loading needs for both time and vehicle type. Two loading zones are proposed for this block – one at the Gottingen Street – Cornwallis Street intersection that can accommodate a tractor trailer or multiple smaller delivery trucks (this will allow loading operations to access a signalized crosswalk, with curb cuts, and allow access to both sides of the street); a second loading zone has been proposed as far north as possible, while maintaining the current bus stop location. There are also existing loading zones on Cunard Street and Cornwallis Street that are accessible by businesses on the west side of the street.

Cornwallis Street to Portland Place

Existing and proposed parking / loading for the section of Gottingen Street between Cornwallis Street and Portland Place is summarized in Table 5.

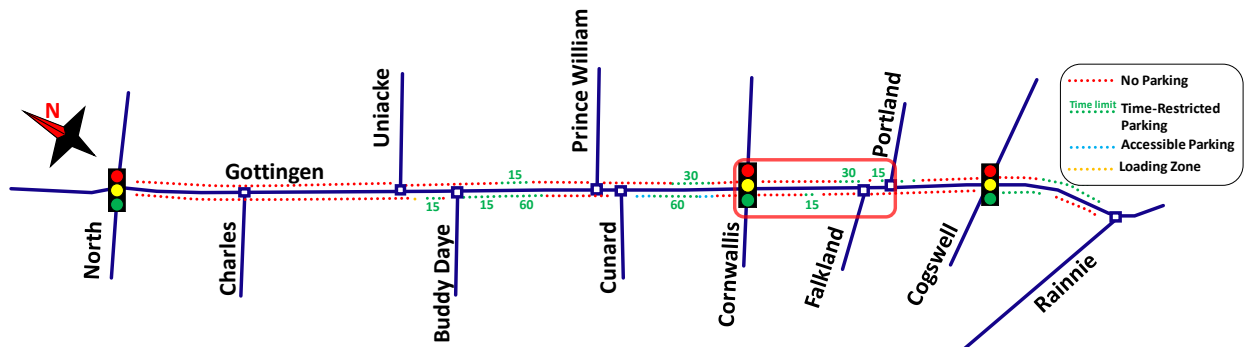

Figure 11: Cornwallis Street to Portland Street Parking and No Parking (Loading Permitted) Areas

Table 5: Cornwallis Street to Portland Place Curbside Inventory

		# of On-Street Off-peak Parking Spaces			Parking Usage		No Parking (Loading Permitted)	
		Existing	Proposed	Net Change	Average Occupancy	Average Duration	Existing	Proposed
Cornwallis Street to Portland Place	East Side	7	10	+3	53%	60 mins	35 m	12 m
	West Side	1	0	-1	61%	54 mins	25 m	0 m
	Total	8	10	+2	54 %	60	60 m	12 m

Parking

This block currently has one legal parking space on the west side. It will be removed, but there will be 3 spaces added to the east side. There will be a net gain of 2 parking spaces. The parking utilization survey found that average occupancy was 54% and average duration was approximately 60 minutes. The current parking controls are 15-30 minutes on this block.

Loading

Some businesses on this block can load off-street, and others are able to load from side streets. All loading surveys that were received from businesses on this block indicated that mid-sized trucks and cargo vans are typically used for loading and deliveries. The design has incorporated a 12m loading zone suitable for mid-sized delivery trucks located at mid-block (where fewer businesses have the option to load off-street or from side streets).

Portland Place to Cogswell Street

Existing and proposed parking / loading for the section of Gottingen Street between Portland Place and Cogswell Street is summarized in Table 6.

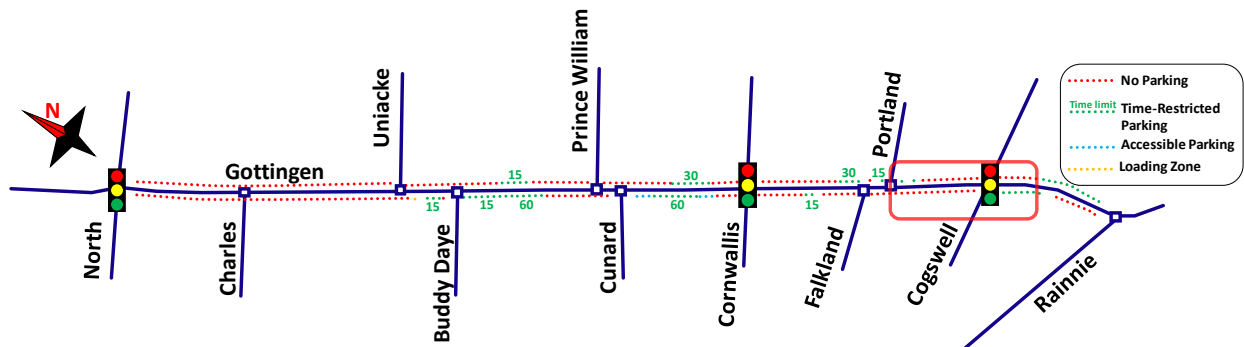

Figure 12: Portland Place to Cogswell Street Parking and No Parking (Loading Permitted) Areas

Table 6: Portland Place to Cogswell Street Curbside Inventory

		# of On-Street Off-peak Parking Spaces			Parking Usage		No Parking (Loading Permitted)	
		Existing	Proposed	Net Change	Average Occupancy	Average Duration	Existing	Proposed
Portland Place to Cogswell Street	East Side	4	4	-	90%	285 mins	12 m	12 m
	West Side	0	0	-	-	-	75 m	12 m
	Total	4	4	-	90 %	285 mins	87 m	24 m

Parking

There is no existing parking on the west side of the street, and the four existing spaces on the east side of the street will remain in their current location. Parking occupancy was observed to be 90%, with an average duration of 285 minutes. There is currently no time limitation on parking for this block. Addition of time restrictions for these spaces should encourage turnover and benefit access to businesses.

Loading

Many businesses on this block have off-street access for loading, and are also close to side streets that have parking and loading areas. The proposed design includes a 12m “No Parking” on each side of the street that will accommodate loading. This is the only block on Gottingen Street that has sufficient width to allow the proposed design to accommodate on-street loading on the west side of the street.

Concluding Thoughts

The proposed design for the Gottingen Street transit lane will require considerable changes to the way that on-street parking and loading activities currently occur. Given the time-dependent nature of the transit lane, impacts will vary depending on the time of day. During peak periods (7-9AM, 3-6PM), all on-street parking and loading on both sides of the street will be prohibited. During off-peak periods, parking and loading will be accommodated on the east side of Gottingen Street; however, on-street parking and loading will not be permitted on the west side of the street.

Recognizing the importance of both of these curbside activities to businesses and residents of the area, the Parking Loss Mitigation Plan has been prepared to develop a better understanding of parking/loading needs on the street, review the impacts resulting from the proposed design, and identify opportunities to mitigate any anticipated losses. In preparing the detailed design and parking loss mitigation plan, staff have completed an investigation of existing on-street parking and loading activities on Gottingen Street that included a detailed parking / loading inventory, collection of utilization data, and consultation with local stakeholders and the public.

A key focus during the design process was placed on mitigating the amount of parking and loading areas lost during the off-peak periods, and strategically locating loading in areas where it can best accommodate businesses and residents. The primary approach used to achieve these objectives included improving the efficiency of curb space usage on the east side of Gottingen Street, which is currently not optimal. The proposed design requires the loss of 28 parking spaces on the west side of the street, which is offset to a large extent by the addition of 20 off-peak parking spaces on the east side of the street. Overall, the net loss of on-street parking spaces during off-peak periods has been limited to eight spaces.

Parking utilization observations on Gottingen Street suggest that parking occupancy is relatively low on Gottingen Street, with long average parking duration that extends beyond current time restrictions. These results suggest that on-street parking on Gottingen Street is being abused, which to an extent can be attributed to a lack of adequate parking enforcement. It is expected that the time-dependent parking created through this project will promote the high turnover on-street parking that typically benefits businesses. The need for diligent enforcement as part of project implementation, which will be critical both for transit operation and parking turnover, cannot be understated.

The proposed design has allocated No Parking/Loading zones on each block of the east side of Gottingen Street. Areas intended for loading will be signed as “No Parking” to provide more flexibility in the loading activities for businesses and simplify signage requirements. Loading zones are typically available for loading on weekdays (6AM-6PM), and available for parking outside of those hours. Signing loading areas as “No Parking” will reserve the space for loading on weekends and all hours outside of peak periods on weekdays.

It is not anticipated that loading activities for businesses on the east side of Gottingen Street will be impacted significantly. However, businesses on the west side of the street will be impacted by the full-time loss of loading along the frontage of their properties. Alternative arrangements will

be required to facilitate loading, which may include parking in designated loading areas on the east side, or by using side streets. On-street loading areas have been placed near crosswalks, where possible, to make loading from the opposite side of the street easier and safer. It is noted that under current conditions, businesses cannot always rely on the availability of loading in front of their properties, particularly in locations that allow all day parking. It is also recognized that indirect loading is a reality in many other locations in the urban core, and is expected to continue to be a necessary trade-off on streets where limited width does not allow more convenient alternatives.

HALIFAX

Gottingen Street Transit Priority Corridor – Public Feedback



May 2018

halifax.ca/integratedmobility

1. How would you best describe your relationship with Gottingen Street and the surrounding neighbourhood?

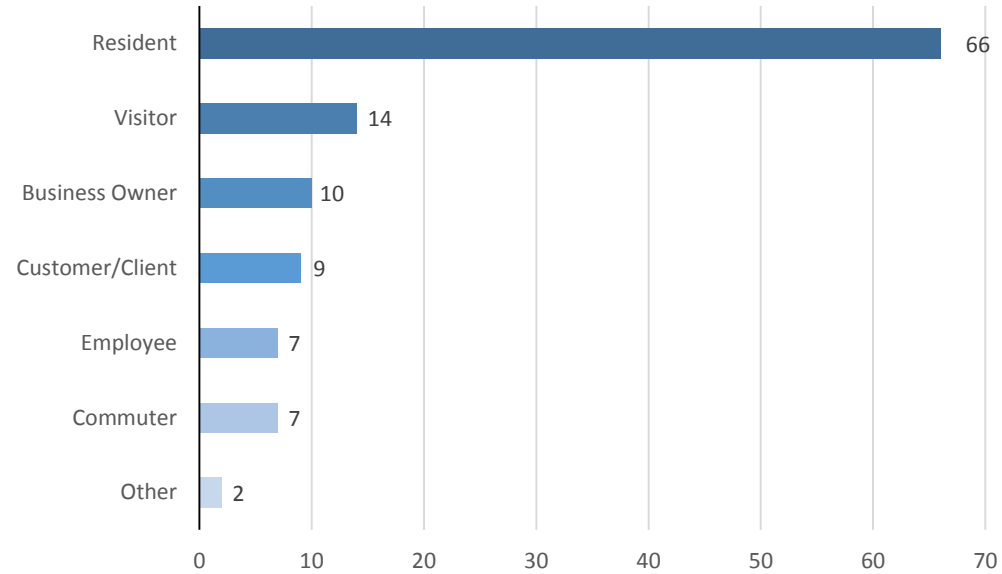

2. Finish the sentence: I _____ on Gottingen Street.
(Check all that apply)

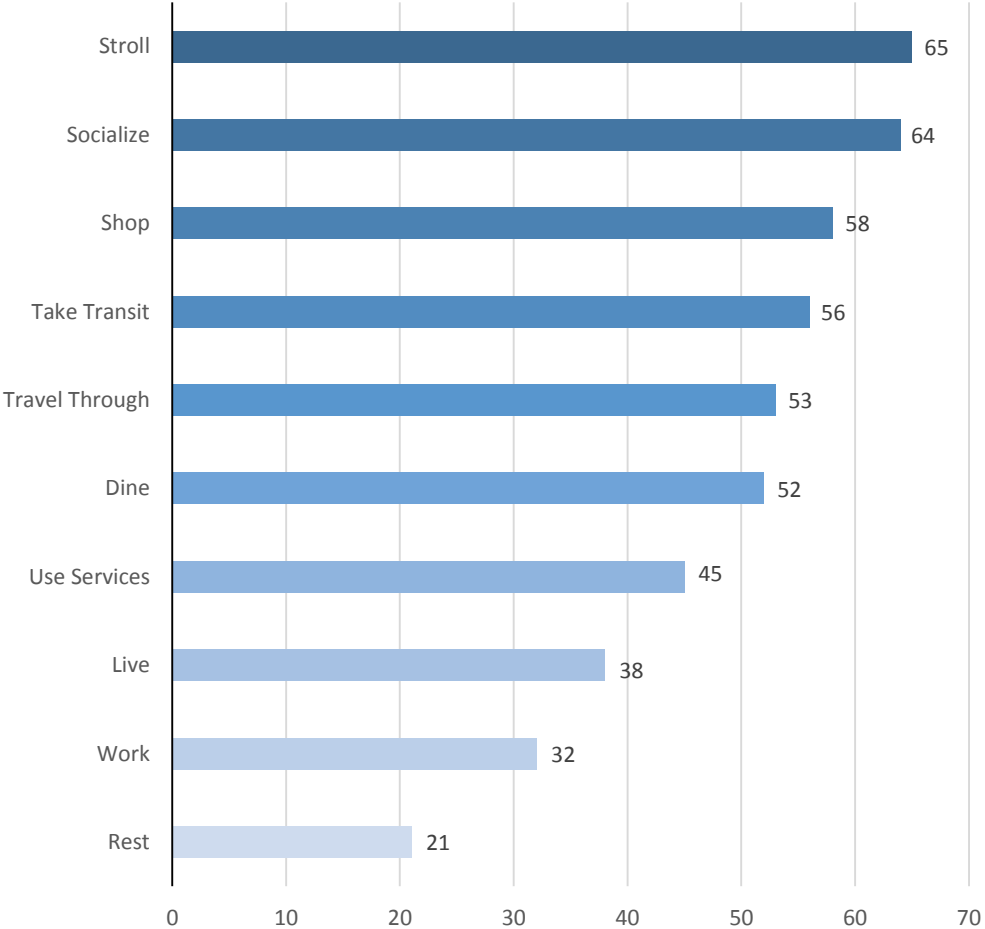

3. Finish the sentence: I am on Gottingen Street
_____.(Check most applicable)

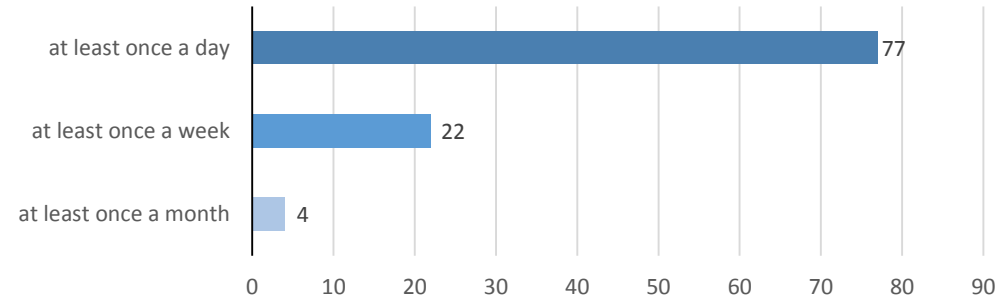

4. Rank the travel modes you use to get to Gottingen Street from most frequent to least frequent.

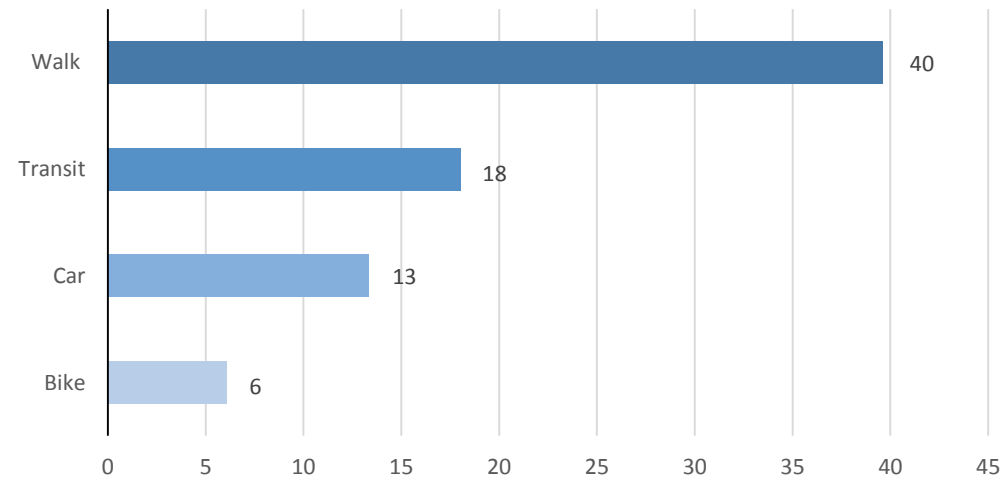

5. Finish the sentence: I park on Gottingen Street
_____. (Check the most applicable)

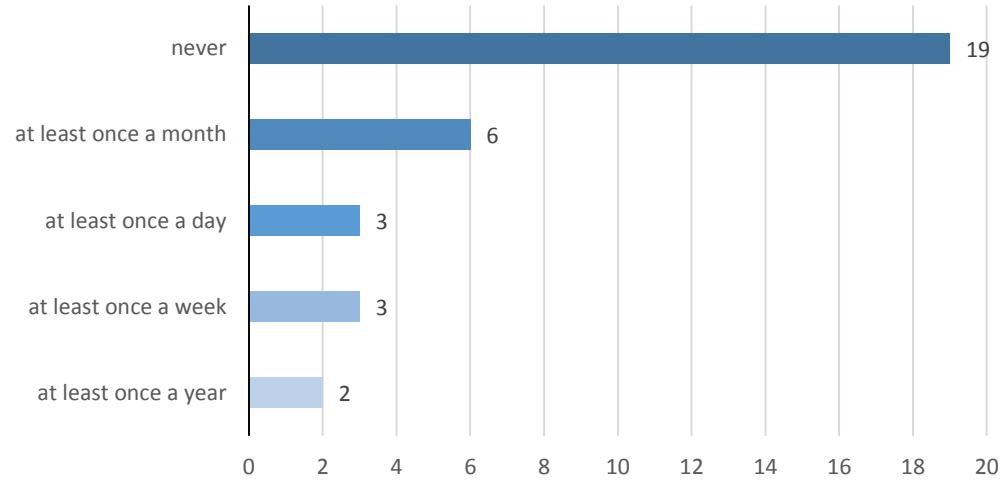

6. Finish the sentence: I use a taxi on Gottingen
Street _____. (Check the most
applicable)

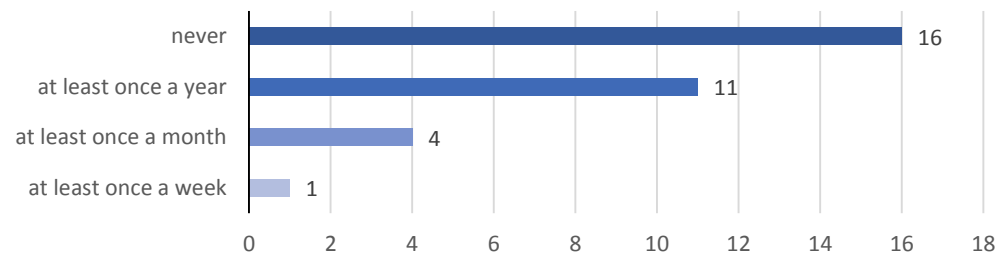

7. Do you have challenges with personal mobility?

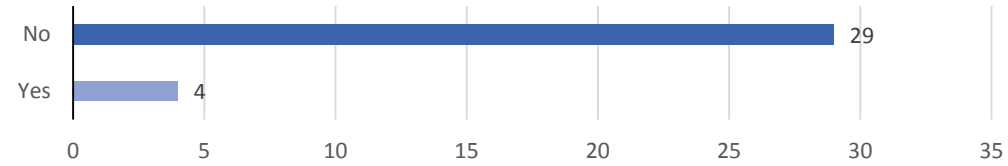

8. Do you currently use an accessible parking permit in the Gottingen Street area?

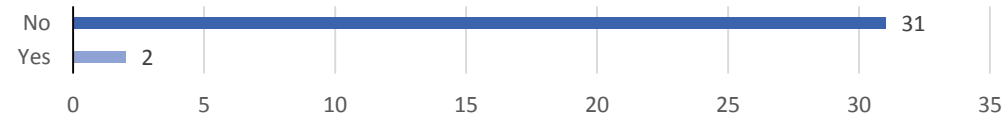

9. Do you currently use a parking permit in the Gottingen Street area?

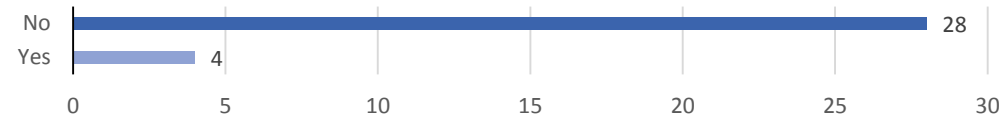

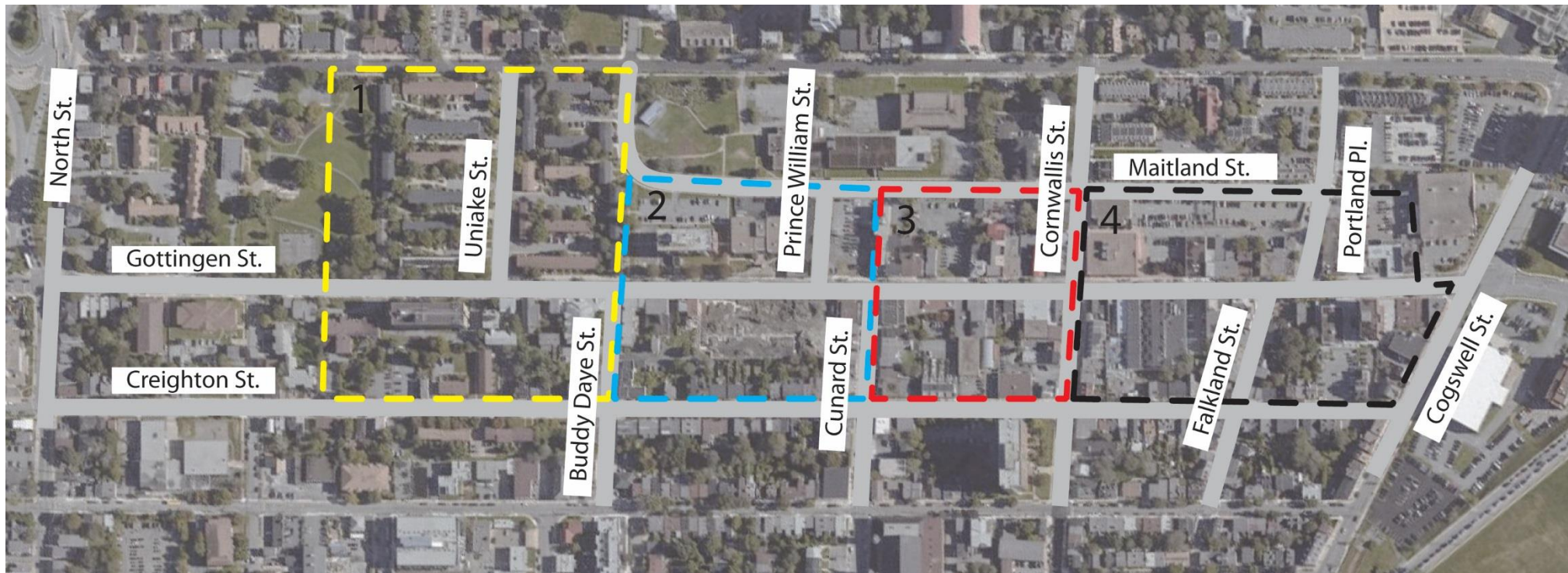

10a. For each zone, check the box if the statements below are true. Zone 1 (Yellow area)

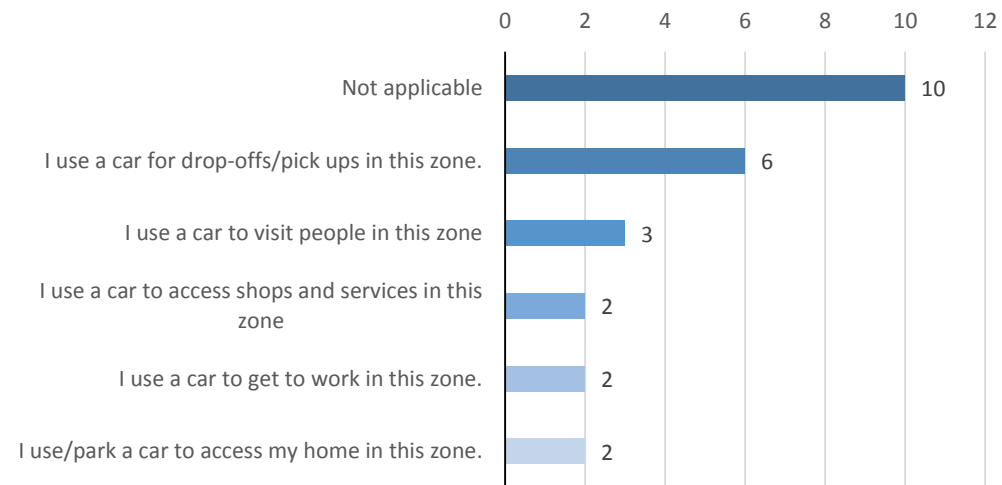

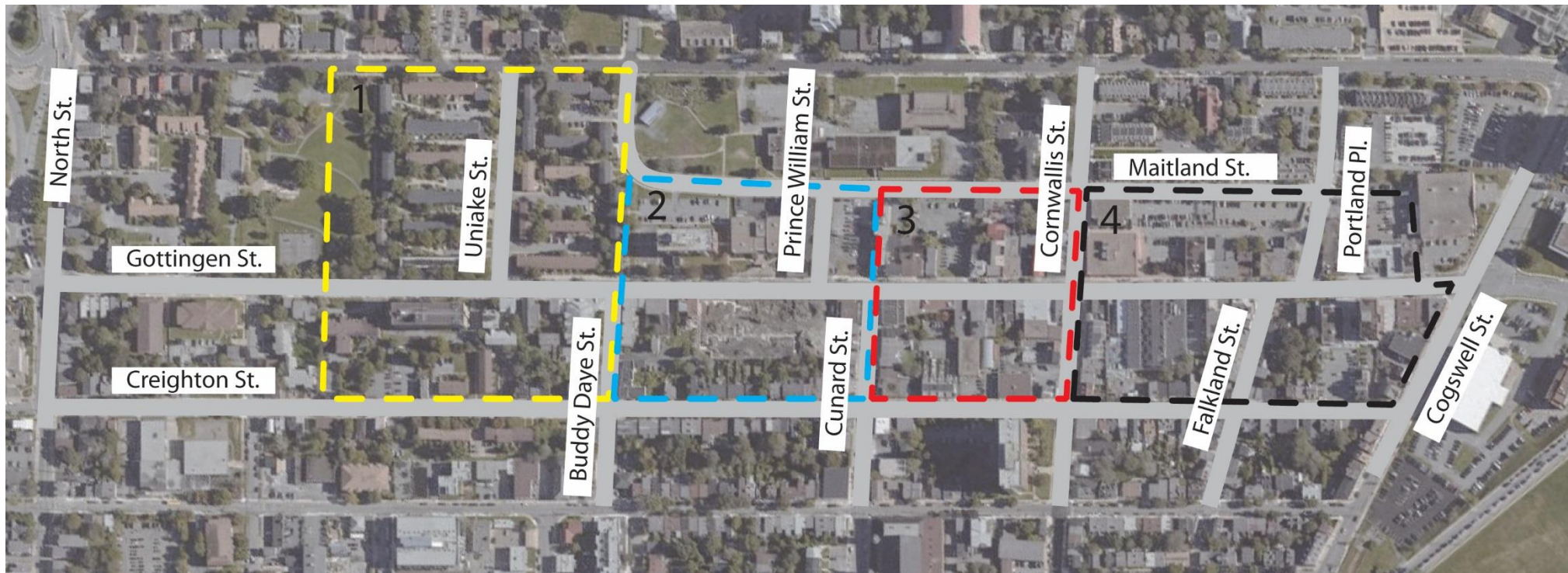

10b. For each zone, check the box if the statements below are true. Zone 2 (Blue area)

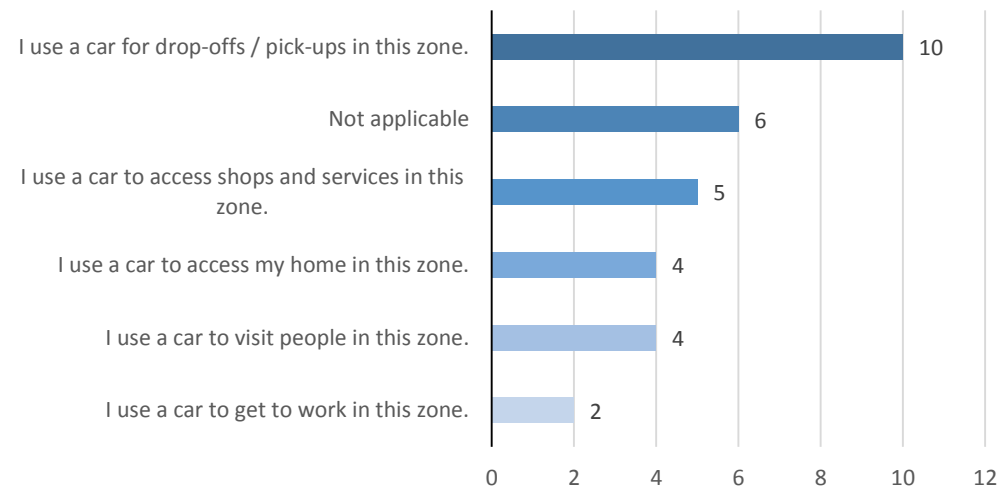

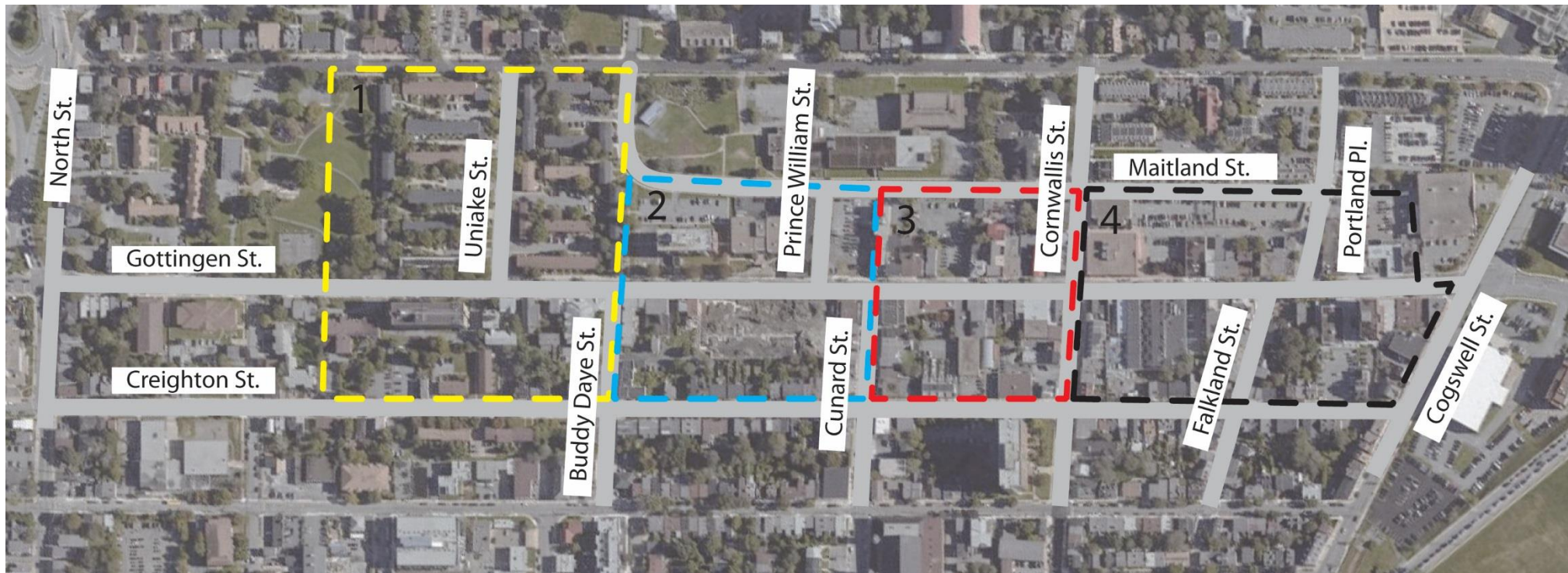

10c. For each zone, check the box if the statements below are true. Zone 3 (Red area)

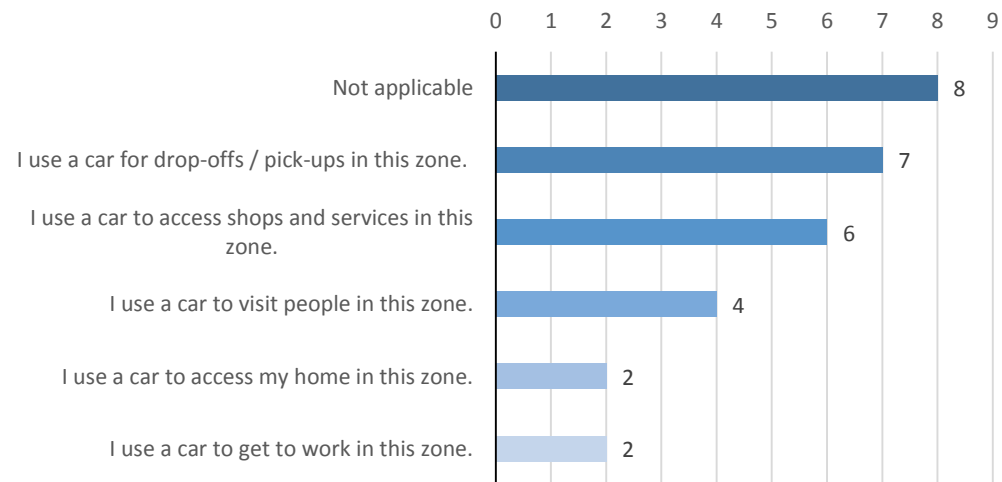

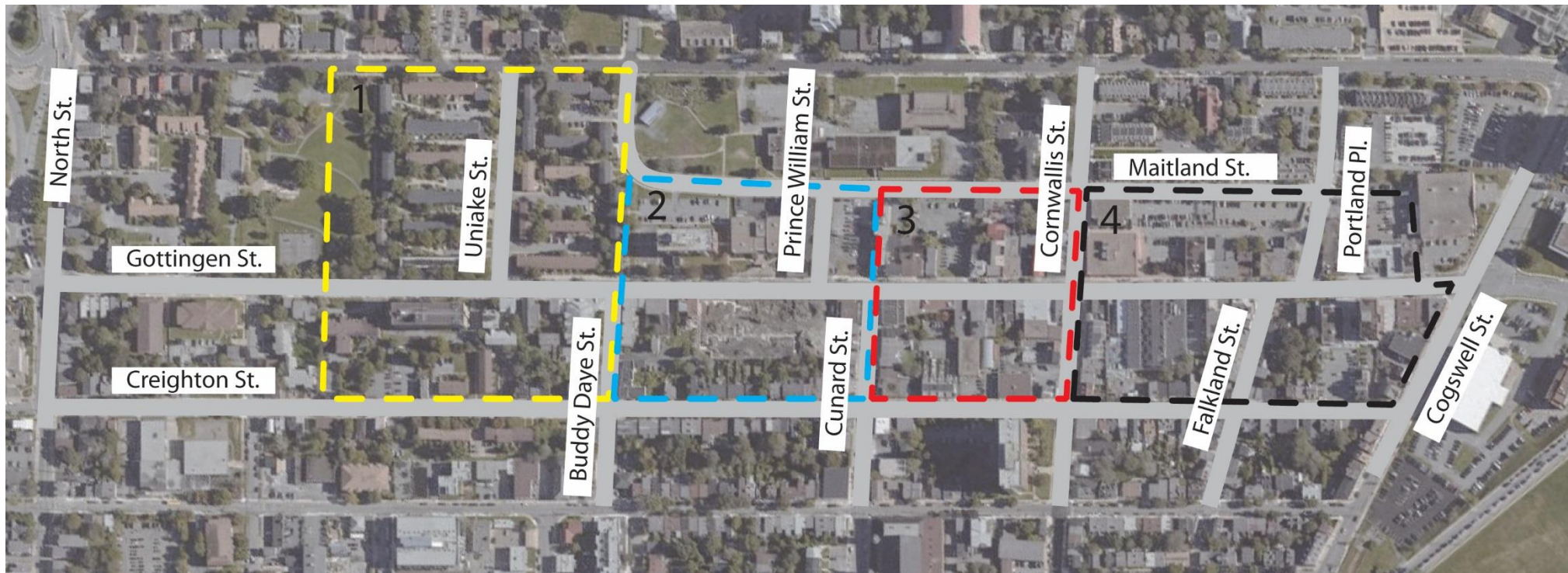

10d. For each zone, check the box if the statements below are true. Zone 4 (Black area)

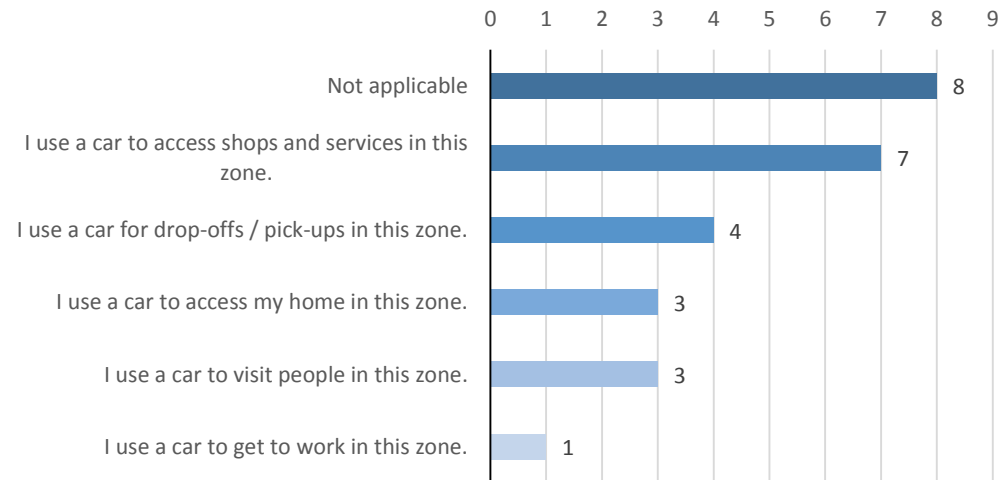

11. Select your top 3 most desired elements for Gottingen Street.

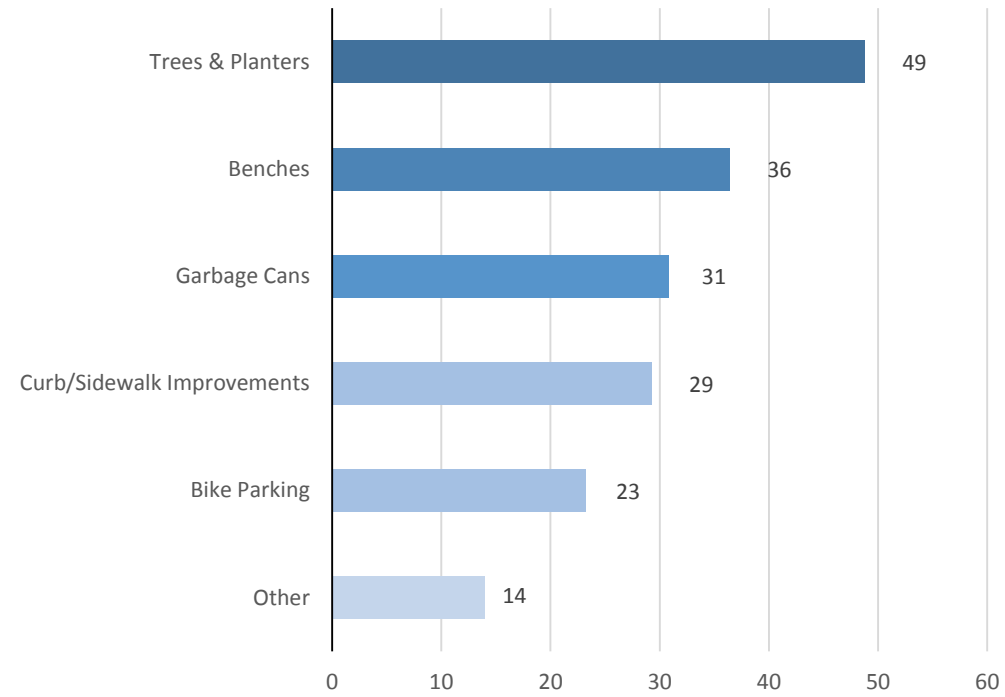

12a. Are you comfortable on Gottingen Street?

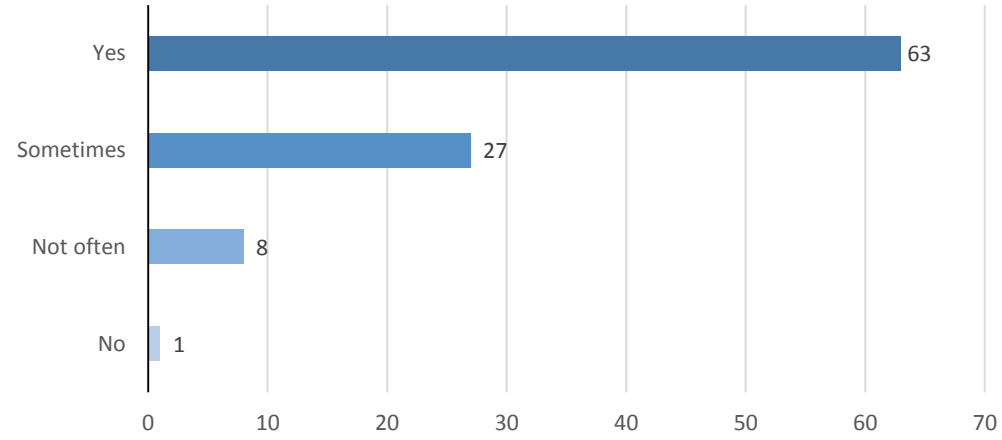

12b. Do you find it easy to travel on Gottingen Street?

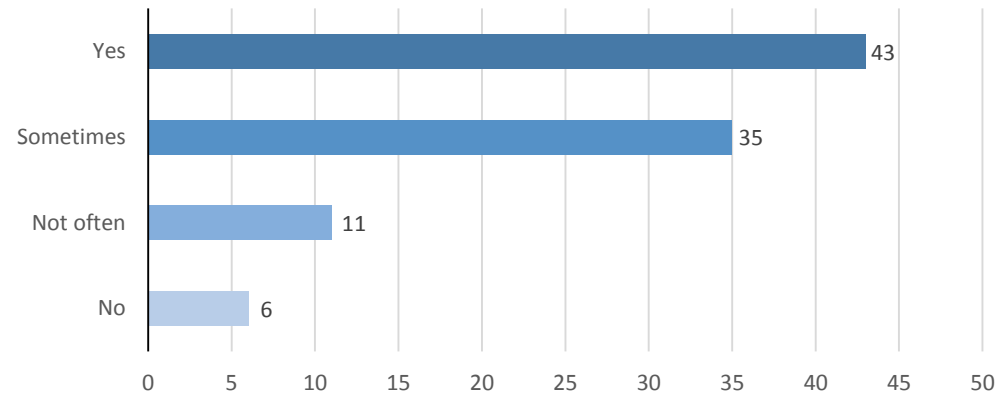

Monitoring & Evaluation Plan

Gottingen Street Transit Priority Corridor

Prepared by:

Halifax Transit
June 2018

Table of Contents

- Introduction 3**
- Background 3
- Objectives 3
- Deliverables..... 3
- Metrics 3**
- Data Collection Timeline..... 7**

List of Tables

- Table 1 Project Evaluation Metrics 4
- Table 2 Data Collection Timeline..... 8

Introduction

Background

In March 2018, Regional Council directed staff to proceed with detailed design of a time-restricted northbound bus lane on Gottingen Street that is operational during weekday peak periods (7am-9am and 3pm-6pm), and that accommodates time-regulated parking and loading outside of peak periods. Staff were further directed to develop a plan to measure and evaluate the impact of the project and recommend changes, if any, within one year of implementation.

The Monitoring and Evaluation Plan, presented in the sections below, identifies fifteen metrics which staff recommend to evaluate to better understand the impact of the project on transit service, mode share, road safety, parking, the street environment, and adjacent land uses.

Objectives

The primary objective of the Monitoring and Evaluation Plan is to determine the extent to which the Gottingen Street peak period northbound bus lane project achieves desired outcomes, particularly regarding transit service improvements, while understanding the implications for other potential related impacts.

Deliverables

The key deliverable of this plan is a staff report to Regional Council, one year after project implementation, that will present the monitoring and evaluation results, identify any areas for improvement and recommend suitable design refinements.

Metrics

Staff have identified fifteen metrics to monitor post-implementation of the time restricted northbound bus lane based on project objectives, public feedback, available staff and data collection resources. Table 1 introduces and categorizes each metric by impact area (transit, all transportation modes, non-transit motorists, street environment, land uses and parking), states how the data will be collected, and identifies the desired outcome.

While each of the identified metrics provide valuable insight, it is important to consider some key limitations of their monitoring and evaluation over the short-term. Due to the inherent variability in some of the metrics, year over year observations are not generally a reliable performance indicator. Observation of trends over multiple years is required to develop meaningful conclusions. Also, each metric is influenced by other external factors unrelated to the changes introduced by the proposed bus lane. These limitations should be considered when evaluating the project after implementation.

Table 1 Project Evaluation Metrics

#	CATEGORY	METRIC	DESCRIPTION
1	Transit	Change in average transit travel time and variability	<p>Transit travel time will be obtained through Automatic Vehicle Locator (AVL) technology to calculate and compare the average travel time and variability of pre- and post-implementation project conditions.</p> <p>The desired outcome would be a decrease in the average travel time and variability for buses in both directions during the peak periods.</p>
2	Transit	Rider experience	<p>Rider experience will be assessed by obtaining feedback through surveys conducted on buses and/or online.</p> <p>The desired outcome would be that most of the survey responses are positive and support the project.</p>
3	Transit	Transit operator experience	<p>Transit operator experience will be assessed by obtaining feedback through surveys.</p> <p>The desired outcome would be that most of the survey responses are positive and support the project.</p>
4	Transit	Change in ridership	<p>Ridership will be assessed by comparing data on the number of onboard passengers, for each transit route using Gottingen Street, pre- and post-implementation of the project.</p> <p>The desired outcome would be an increase in the number of onboard passengers for each transit route during peak periods.</p>

#	CATEGORY	METRIC	DESCRIPTION
5	Transit	Change in number of transit related collisions (vehicle damage only)	<p>Transit related collisions will be obtained through transit collision reports pre- and post-implementation of the project for comparison.</p> <p>The desired outcome would be a decrease in the number of transit-related collisions.</p>
6	All Modes	Change in total person throughput	<p>Total person throughput will be obtained by conducting manual screenline counts of people and their respective travel mode pre- and post-implementation of the project for comparison.</p> <p>The desired outcome would be an increase in the number of people traveling by transit (for each transit route) and active transportation modes during the PM peak.</p>
7	All Modes	Cross section allocation	<p>Cross section allocation will be assessed by comparing mode splits to the right-of-way width assigned to each travel mode pre- and post-implementation of the project.</p> <p>The desired outcome would be that right-of-way width assigned to each travel mode corresponds more closely to the mode split.</p>
8	All Modes	Public experience	<p>Public experience of all people who use Gottingen Street will be assessed by obtaining feedback through surveys conducted on street and/or online.</p> <p>The desired outcome would be that most of the survey responses are positive and support the project.</p>

#	CATEGORY	METRIC	DESCRIPTION
9	All Modes	Change in number and severity of collisions	<p>The number and severity of collisions will be obtained from Halifax Regional Police collision reports pre- and post-implementation of the project for comparison.</p> <p>The desired outcome would be no increase in the number and severity of collisions.</p>
10	All Modes	Change in how people are accessing the street	<p>Obtaining data on how people are accessing Gottingen Street will be through conducting on-street intercept surveys pre- and post-implementation of the project.</p> <p>The desired outcome would be an increase in the number of people accessing the street via transit and active transportation modes.</p>
11	Non-Transit Motorists	Non-adherence of transit lane	<p>Non-adherence of the transit lane will be assessed by obtaining information on the number of parking tickets and tows and/or through monitoring using time lapse/video cameras during peak periods.</p> <p>The desired outcome would be that few blockages to transit vehicles occur in the peak periods after a year from implementation.</p>
12	Non-Transit Motorists	Change in 85 th percentile speed	<p>85th percentile speed will be obtained by conducting speed volume surveys pre- and post-implementation of the project for comparison.</p> <p>The desired outcome would be no significant increase in the 85th percentile speeds.</p>

#	CATEGORY	METRIC	DESCRIPTION
13	Street Environment	Number of installed streetscape elements (ex. # of planted trees)	<p>The number of installed streetscape elements will be recorded in a document as they are installed/constructed.</p> <p>The desired outcome would be an increase in the number of streetscaping elements.</p>
14	Parking	Parking utilization	<p>Parking utilization data will be obtained by conducting parking utilization surveys, of Gottingen Street and the surrounding neighbourhood, post-implementation of the project for evaluation.</p> <p>The desired outcome would be that the 85th percentile parking occupancy is at or less than 85%.</p>

Data Collection Timeline

The proposed data collection timeline is presented in Table 2 using five time period columns. The baseline column represents data that are required to be collected before project implementation. These data already exist or are planned for collection in the coming months. The next four columns represent data collection throughout the year after project implementation divided into three-month increments, and the last column represents data that must be monitored on an ongoing basis after the initial data collection year. The proposed timeline may vary to accommodate staff resources and the reporting timeline requested by Regional Council (i.e. report back within one year of implementation).

Table 2 Data Collection Timeline

#	METRIC	DATA COLLECTION TIMELINE					
		Baseline	0-3 MO	3-6 MO	6-9 MO	9-12 MO	Ongoing
1	Change in average transit travel time	✓	✓	✓		✓	
2	Rider experience			✓			
3	Transit operator experience			✓			
4	Change in ridership	✓			✓		✓
5	Change in number of transit related collisions	✓				✓	
6	Change in total person throughput	✓	✓		✓	✓	✓
7	Cross section allocation	✓				✓	
8	Public experience			✓			
9	Change in number and severity of collisions	✓				✓	✓
10	Change in how people are accessing the street	✓			✓		
11	Non-adherence of transit lane			✓		✓	
12	Change in 85 th percentile speed	✓			✓		
13	Number of installed streetscape elements					✓	
14	Parking utilization	✓		✓			

HALIFAX | Transit Priority Corridor: Gottingen Street



Transportation Standing Committee
July 26th, 2018

halifax.ca/integratedmobility

Background

The Council approved Moving Forward Together Plan (MFTP) (April 2016)

- Identifies Gottingen Street as a critical choke point for transit service that requires transit priority.
- The MFTP recommends investment in transit priority measures that provide priority to the movement of buses over general traffic.

These recommendations have been further reinforced by policy direction in the Council approved Integrated Mobility Plan (December 2017)



Background

In May 2017 a consultant was hired to complete a functional design study for the Gottingen Street transit priority corridor.

The functional design study was completed in January 2018 and considered multiple design options for the Gottingen Street corridor.

Based on the findings from the study and input from the public and stakeholders, staff recommended the preferred concept – a dedicated, continuous northbound bus lane on Gottingen Street – be advanced to detailed design and implementation.



Motion Tasks



Completed Detailed Design for a continuous peak hour northbound bus only lane



Completed a Parking Loss Mitigation Plan, including public and stakeholder engagement



Developed a Monitoring & Evaluation Plan



Supplementary Report: Potential to move northbound express buses off Gottingen Street to alternate routes



Proposed Street Configuration

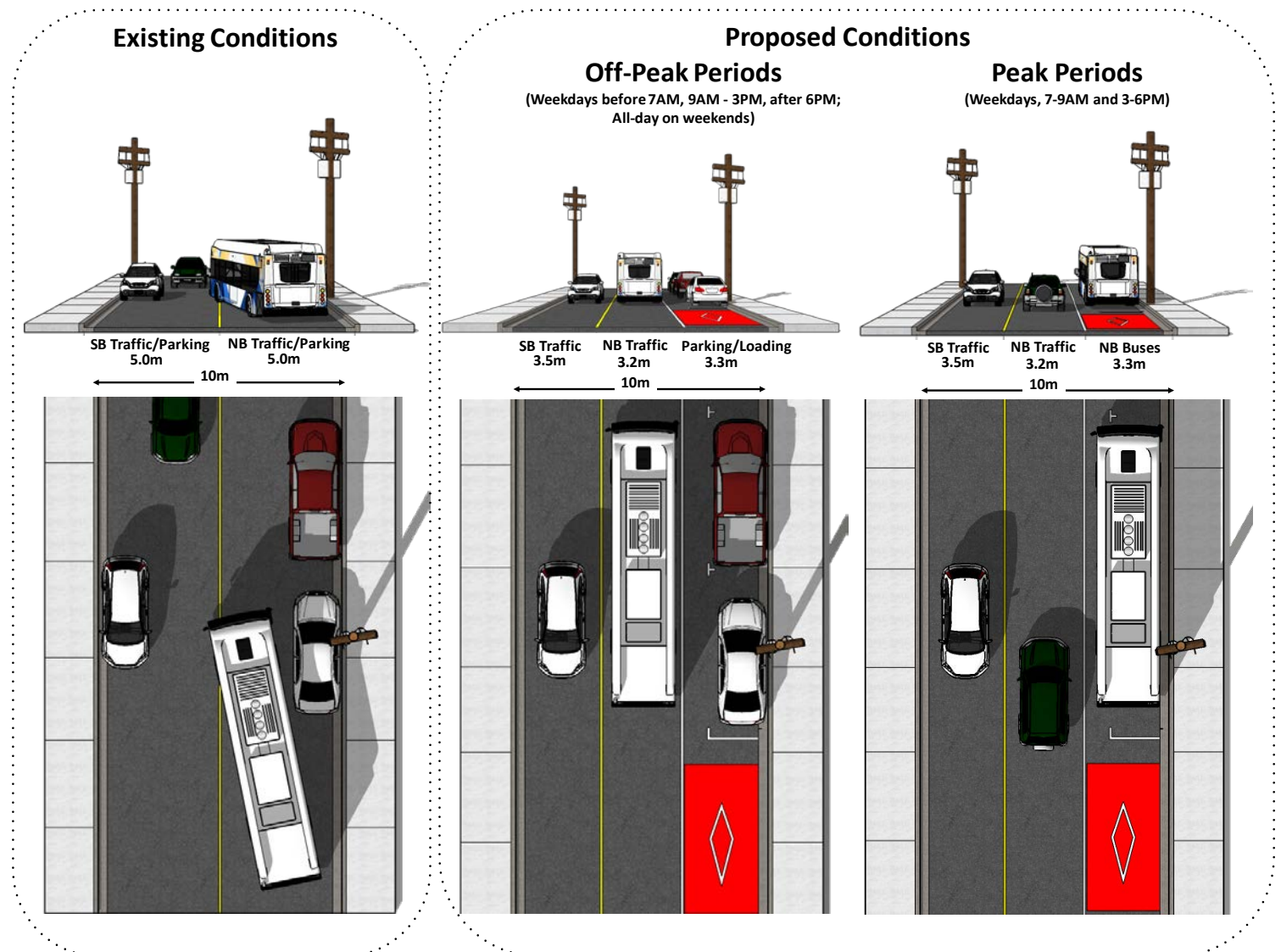

Parking Loss Mitigation

		# of On-Street Off-peak Parking Spaces		
		Existing	Proposed	Net Change
North Street to Uniacke Street	East Side	0	6	+6
	West Side	0	0	-
Uniacke Street to Prince William Street	East Side	6	15	+9
	West Side	15	0	-15
Prince William Street to Cornwallis Street	East Side	7	9	+2
	West Side	12	0	-12
Cornwallis Street to Portland Place	East Side	7	10	+3
	West Side	1	0	-1
Portland Place to Cogswell Street	East Side	4	4	-
	West Side	0	0	-
Total		52	44	-8



Stakeholder & Public Consultation

Stakeholder/Community consultation activities included:

- Parking / Loading Questionnaire
- On-Street Pop-up Engagement Sessions
- NEBA Stakeholder Meeting (May 14th, 2018)
- Public Open House (May 17th, 2018)
- Online Engagement (Shape Your City)

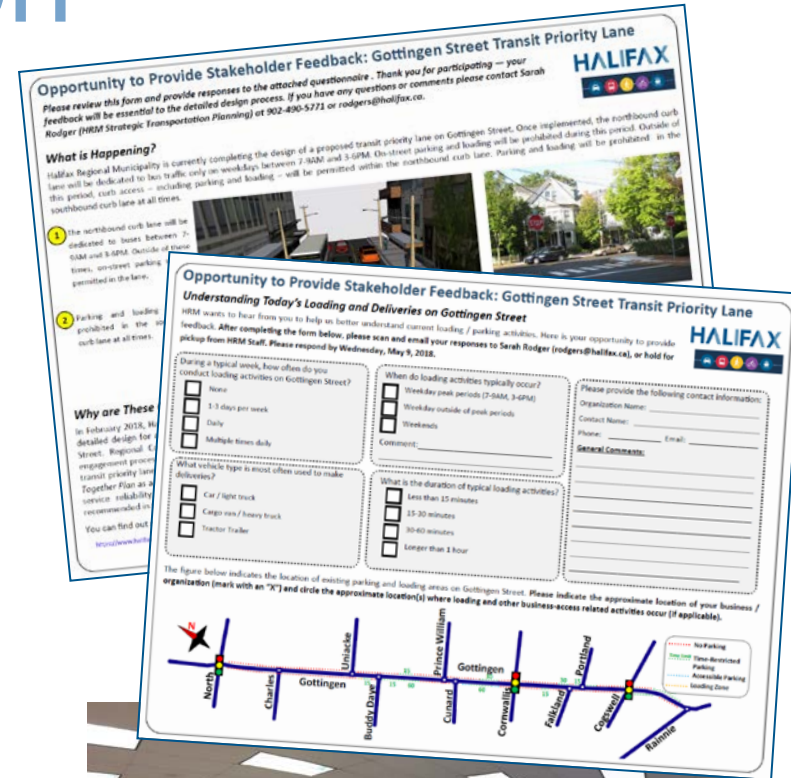

Public & Stakeholder Engagement

Feedback from consultation was mixed. **Many agreed that transit priority is needed, however common concerns included:**

- Potential loss of on-street parking and loading
- Comfort and safety with the addition of a third traffic lane
- Volume of buses using Gottingen Street, lack of consideration of alternatives that would reduce transit routing to Gottingen



Public & Stakeholder Engagement

Potential complete streets enhancements were an important focus of engagement efforts for the project. There was **strong support** for several complete streets improvements including:

- Trees & Planters
- Garbage Cans
- Bicycle Parking
- Benches
- Curb & Sidewalk Improvements



Complete Streets Elements

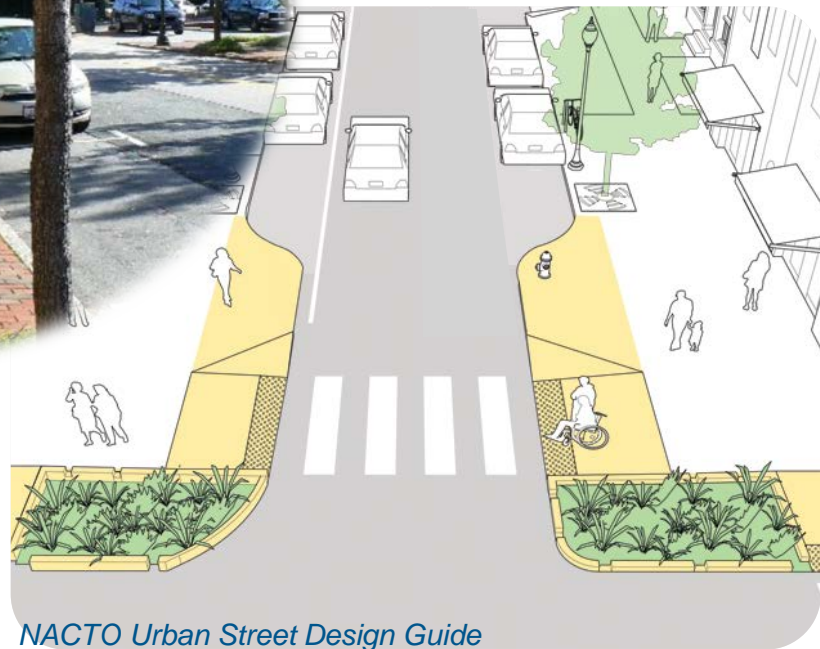
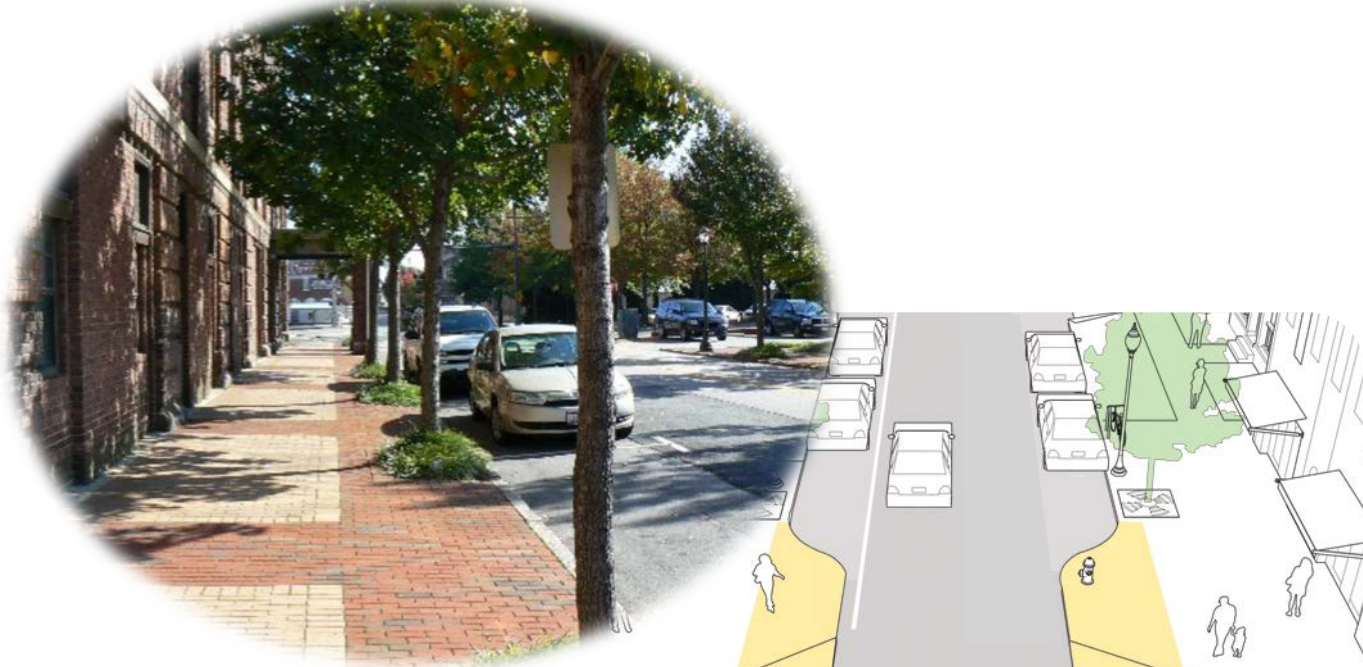

NACTO Urban Street Design Guide

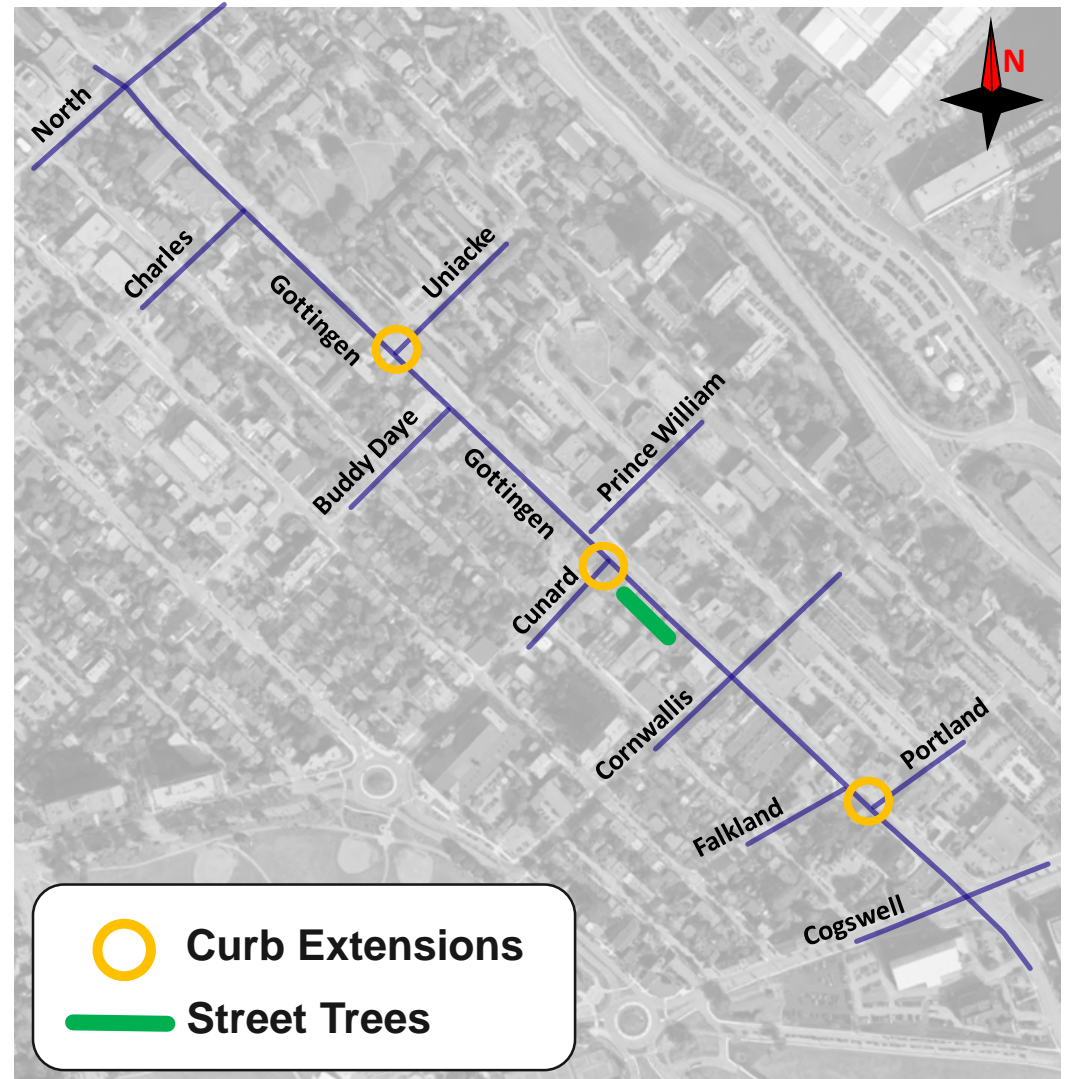

Monitoring & Evaluation Plan

Primary Objective

To measure the extent to which the project is successful using predefined metrics.

Deliverable

Staff report to Regional Council, one year after project implementation, that will:

- present the monitoring and evaluation results
- identify any areas for improvement
- recommend suitable design refinements.



Evaluation & Monitoring Plan: Metrics

- Public Experience
- Change in number and severity of collisions
- Change in how people are accessing the street
- Change in 85th percentile speed
- Number of installed streetscape elements
- Non-adherence of transit lane
- Parking utilization
- Cross section allocation
- Change in total person throughput
- Change in number of transit related collisions
- Change in average transit travel time & variability
- Rider experience
- Transit operator experience
- Change in ridership



Next Steps

- Transportation Standing Committee Approval (July 26th, 2018)
- Regional Council Approval (August 14th, 2018)
- Collection of baseline evaluation and monitoring data (June - September 2018)
- Construction Tender Award (September 2018)
- Moving Forward Together Plan Corridor Route Review / Macdonald Bridge Ramp / Express Route Review Supplementary Reports to TSC (Fall 2018)
- Implementation of the Transit Priority Corridor & Complete Street Elements (Fall 18)
- Collection of post-implementation evaluation and monitoring data (Fall 18 to Fall 19)
- Monitoring & Evaluation Plan report to Regional Council (Fall 2019)



Recommendation

It is recommended that the Transportation Standing Committee recommend that Halifax Regional Council:

- 1. Approve detailed design as shown in Attachment B of the staff report dated June 21, 2018.**
- 2. Approve the parking loss mitigation plan as described in Attachment C of the staff report dated June 21, 2018.**
- 3. Direct staff to proceed with implementation of a peak period (7am-9am and 3pm-6pm, Monday to Friday) northbound bus lane on the Gottingen Street corridor.**
- 4. Approve the evaluation methodology as per Attachment E of this report through which the Gottingen Street peak period northbound bus lane will be measured and evaluated one year after implementation.**



HALIFAX | THANK YOU



halifax.ca/integratedmobility